

PNAAV-716

46.82

**A Hatchery Manual for the Common,
Chinese and Indian Major Carps**

**V. G. Jhingran
R. S. V. Pullin**

1985

**ASIAN DEVELOPMENT BANK
INTERNATIONAL CENTER FOR LIVING AQUATIC RESOURCES MANAGEMENT**

**A Hatchery Manual for the Common,
Chinese and Indian Major Carps**

**V.G. JHINGRAN
R.S.V. PULLIN**

1985

Published by the Asian Development Bank,
P.O. Box 789, Manila, Philippines and the
International Center for Living Aquatic
Resources Management, MCC P.O. Box 1501,
Makati, Metro Manila, Philippines

Copyright 1985 by the Asian Development Bank

Printed in Manila, Philippines

V.G. Jhingran and R.S.V. Pullin. 1985. A hatchery manual
for the common, Chinese and Indian major carps. ICLARM
Studies and Reviews 11, 191 p. Asian Development Bank,
Manila, Philippines and International Center for Living
Aquatic Resources Management, Manila, Philippines

ISSN 0115-4389
ISBN 971-1027-17-6

Cover: Common carp (Cyprinus carpio) by Ovidio Espiritu, Jr.

ICLARM Contribution No. 252

Contents

	Page
List of Tables	vi
List of Illustrations	viii
Preface	x
Chapter 1 Biology of Cultured Carps	1
GRASS CARP	1
SILVER CARP	3
BIGHEAD CARP	6
COMMON CARP	7
CATLA	10
ROHU	13
MRIGAL	15
Chapter 2 Components of a Carp Hatchery	20
THE SITE	20
PLANNING FOR HATCHERY CONSTRUCTION	21
ESSENTIAL COMPONENTS OF A HATCHERY	22
REQUIREMENTS OF BROODFISH AND BROODFISH PONDS	24
STRUCTURAL FEATURES OF DIFFERENT TYPES OF PONDS	25
PLACEMENT OF DIFFERENT TYPES OF PONDS IN A HATCHERY	26
THE HATCHERY PROPER	27
OPERATIONAL PROCEDURES OF A HATCHERY PROPER	36
Chapter 3 Broodfish Care	38
SOURCES OF BROODFISH	38
CHARACTERISTICS OF BROODFISH PONDS	38
POND FERTILIZATION AND MANURING	40
FEEDS	40
BREEDING SEASONALITY	42
Chapter 4 Induced Spawning of Chinese and Indian Major Carps and Common Carp Breeding	43
STAGES OF MATURITY OF ADULT CARPS	43
DETERMINING READINESS FOR SPAWNING	43
INDUCED SPAWNING OF CHINESE AND INDIAN MAJOR CARPS	44
COMMON CARP BREEDING	55
HATCHING AND CARE OF HATCHLINGS	58

Chapter 5 Postlarvae and Fry Rearing	61
PRE-STOCKING PRACTICES.	62
STOCKING CARP POSTLARVAE IN NURSERY PONDS	68
POST-STOCKING PRACTICES.	69
FISH FEEDING	69
REARING POND MANAGEMENT	70
Chapter 6 Transport of Live Fish Seed and Broodfish	74
CONDITIONING FOR TRANSPORT.	74
TRANSPORT CONTAINERS FOR FISH FRY AND FINGERLINGS.	75
TRANSPORT OF FINGERLINGS AND BROODFISH.	77
USE OF ANESTHETIC DRUGS FOR LIVE-FISH TRANSPORT.	78
Chapter 7 Applied Genetics of Cultured Carps	81
GENERAL CONSIDERATIONS	81
APPROACHES TO STOCK IMPROVEMENT.	82
ADDITIONAL TECHNIQUES.	85
COMMON CARP GENETICS	86
GENETICS OF THE CHINESE CARPS.	90
GENETICS OF THE INDIAN MAJOR CARPS.	90
SUMMARY OF RECOMMENDATIONS FOR HATCHERY OPERATORS	90
Chapter 8 The Nutrition of Cultured Carps	91
INTRODUCTION	91
THE NUTRITIONAL REQUIREMENTS OF ADULT COMMON CARP AND OTHER CULTURED CARPS.	93
THE FEEDING HABITS AND NUTRITIONAL REQUIREMENTS OF CARP POSTLARVAE, FRY AND FINGERLINGS	98
TRENDS IN ARTIFICIAL FEEDS FOR POSTLARVAE, FRY AND FINGERLINGS.	107
FEED ANALYSIS AND FORMULATION.	109
Chapter 9 Diseases of Cultured Carps	117
GENERAL CONSIDERATIONS	117
PREVENTION, PROPHYLAXIS AND TREATMENT	117
VIRAL DISEASES	118
FUNGAL DISEASES.	119
BACTERIAL DISEASES	120
PROTOZOAN INFESTATIONS.	121
PARASITIC HELMINTHS	123
PARASITIC COPEPODS	125
OTHER DISEASES AND ABNORMAL CONDITIONS	126
QUARANTINE MEASURES.	127
GUIDELINES FOR HEALTH CERTIFICATION OF BROODSTOCK USED FOR HIGH QUALITY SEED SUPPLY.	130
DIAGNOSTIC PROCEDURES.	131
Chapter 10 Specialized Scientific Equipment and Implements	133

Chapter 11 Applied Research Problems and Personnel Requirements	138
BIOLOGY AND GENETICS	139
HATCHERY ENGINEERING	140
BROODFISH HUSBANDRY	140
LARVAL REARING	141
HATCHERY MANAGEMENT	142
PERSONNEL REQUIREMENTS	143
SPECIAL RESEARCH REQUIREMENTS	144
Chapter 12 Routine Upkeep and Maintenance Tasks	145
CHINESE AND INDIAN MAJOR CARPS	145
COMMON CARPS	149
References	151
Appendix I. Additional Reading	155
Appendix II. Useful Technical Periodicals	165
Appendix III. Some Asian Units and Their Metric Equivalents	167
Geographical Index	169
Subject Index	171

List of Tables

1.1	Conversion ratios of a few items of grass carp feeds	3
1.2	Growth of grass carp in some countries	3
1.3	Size and age at first maturity of grass carp in different countries.	4
1.4	Size and fecundity of grass carp	4
1.5	Growth of silver carp	5
1.6	Age and size at sexual maturity of silver carp	5
1.7	Fecundity of silver carp of different sizes and ages.	6
1.8	Growth of bighead carp	7
1.9	Size and age at first maturity of bighead carp in different countries.	7
1.10	Growth of common carp in various countries	9
1.11	Size and age at first maturity of common carp under different climatic conditions	9
1.12	Absolute and relative fecundity of common carp in India	10
1.13	Export of Indian major carp seed by Messrs. Fish Seed Syndicate, Calcutta	11
1.14	Natural food of juvenile and adult catla	11
1.15	Growth of catla under culture conditions.	12
1.16	Relation of egg number to body size and age of catla	12
1.17	Sizes attained by rohu at different ages of its life in natural waters	14
1.18	Growth of rohu under culture conditions.	14
1.19	Fecundity of rohu	15
1.20	Spawning season of rohu in different parts of the Indian subcontinent.	15
1.21	Size attained by mrigal at various years of its life in the Rivers Ganga and Yamuna	17
1.22	Growth of mrigal under different culture conditions	17
1.23	Fecundity of mrigal collected from River Yamuna at Allahabad	18
1.24	Average fecundity of mrigal from the River Godavari, India, for different year classes	18
1.25	Spawning season of mrigal in the Indian subcontinent	19
2.1	Characteristics of a satisfactory carp hatchery site	22
2.2	Assumptions to derive pond areas and numbers for a production of 100 t of fish/year.	22
2.3	Number of fingerlings of different species to produce annual harvest of 100 t.	23
2.4	Requirements of different kinds of ponds for production of 100 t/year of table-sized fish	25
2.5	Merits and demerits of different hatching methods.	35
3.1	Ratios of different species of carps in a community broodfish pond	40
3.2	The approximate breeding seasons of cultured carps in selected Asian countries.	42
4.1	Stages of gonadal maturity of carps.	44
4.2	External distinguishing features of sexes of carps	44
4.3	Induced breeding techniques of Chinese carps adopted by various workers.	51

5.1	Pond soil pH and requirements in hundreds of kg/ha of different forms of calcium	63
5.2	Classification of Indian soils based on available phosphorus and nitrogen (mg/100 mg of soil)	66
5.3	Feeding schedule of carp postlarvae/fry for 15 days of rearing	69
5.4	Kinds of feeds given to carp postlarvae	69
5.5	Some feeds and feeding rates for Chinese carp fry and fingerlings	73
6.1	Packing density of fry/fingerlings of Indian major carps for 12-hour journey in 16-18-l capacity plastic bags	76
6.2	An estimation of the amount of O ₂ required for transport of rohu fingerlings	77
7.1	Summary information on some strains of the common carp (<i>Cyprinus carpio</i>) in Europe	88
7.2	Summary information on some strains of the common carp (<i>Cyprinus carpio</i>) in Asia	89
8.1	Composition of a 40% protein carp grower diet	92
8.2	Plant protein digestibility as percentages by ruminants, swine, rabbits and common carp	93
8.3	The essential amino acid requirements of common carp (<i>Cyprinus carpio</i>)	94
8.4	Vitamin requirements of the common carp	96
8.5	Summary of available data on the mineral and trace element requirements of the common carp	97
8.6	Availability of dietary phosphorus in various feed ingredients for common carp and rainbow trout	97
8.7	Food organism preferences of the early life history stages of some Chinese carps	99
8.8	Intake of food organisms by common carp postlarvae/fry	99
8.9	Recommended size/density relationships for early rearing of common and Chinese carp fry on live foods	101
8.10	Characteristics of Artemia cysts used to rear common carp postlarvae	102
8.11	Survival and weight of common carp hatchlings/fry fed Artemia nauplii from various sources	102
8.12	Bioeconomical evaluation of the use of specific Artemia cyst-batches from various geographical origins for carp hatchlings/fry	102
8.13	The nutrient composition of chicken egg	104
8.14	Selected additional information on the provision of live and artificial foods for hatchlings, postlarvae, fry and fingerlings	106
8.15	Analysis of the artificial food-yeast <i>Candida lipolytica</i> in comparison to fishmeal (60-65% protein)	108
8.16	A worksheet for diet formulation with respect to major nutrients and costs	113
8.17	A worksheet for diet formulation with respect to essential amino acids	113
8.18	Ingredients and percentage composition of a supplemental feed for common carp broodstock	115
8.19	Selected additional information on broodstock husbandry and nutrition	115
11.1	Tasks and personnel needs for operation and maintenance of a hatchery	143
12.1	Pre-stocking and post-stocking operations	147

List of Illustrations

1.1	Grass carp, <i>Ctenopharyngodon idella</i>	2
1.2	Silver carp, <i>Hypophthalmichthys molitrix</i>	4
1.3	Bighead carp, <i>Aristichthys nobilis</i>	6
1.4	Common carp, <i>Cyprinus carpio</i> ("big belly" variety)	8
1.5	Catla, <i>Catla catla</i>	10
1.6	Rohu, <i>Labeo rohita</i>	13
1.7	Mrigal, <i>Cirrhinus mrigala</i>	16
2.1	A reverse flow filter	26
2.2	A bird's eye view of the Fish Hatchery and Training Centre, Raipur, Noakhali, Bangladesh	27
2.3	A breeding <i>hapa</i>	27
2.4	A hatching <i>hapa</i>	27
2.5	Twin tanks and ward tanks in a hatchery; also seen are outside- stand pipes or turn-down pipes.	29
2.6	Circular fish breeding, hatching and larvae rearing tanks in a modular design	29
2.7	A circular concrete fish breeding tank; also seen are a side-ways directed inlet and centrally located drain hole over which is fitted a straight perforated pipe covered by a copper screen.	30
2.8	Carp eggs incubating in zoug jars at a fish hatchery in Dinnyeś, Hungary	30
2.9	Baked clay vessels serving as a carp hatchery in a rural area in India.	31
2.10	Hatching jar with water supply from above.	31
2.11	Placement of hatching jars in rows of two atop a rectangular table with a common conduit from jars from each row.	32
2.12	Glass jar hatchery showing drainage from hatching jars through a common conduit into a hatchling holding tank with shower arrangement	32
2.13	An overall view of a glass jar hatchery at Cuttack, India	32
2.14	Funnel-shaped hatching device.	32
2.15	Schematic diagram of a low density polyethylene made six-incubator hatchery unit	32
2.16	Hatchery equipment made of low density polyethylene material showing portable hatchery jars and hatchling containers among others	33
2.17	General view of a modern "Dwivedi" carp hatchery operating at Khutela Bhata Fish Seed Farm, Madhya Pradesh, India	33
2.18	Plastic hatching jars with water supply from above at the Raipur Carp Hatchery, Noakhali, Bangladesh	34
2.19	Side section of a jar-hatchery at the Raipur Carp Hatchery	34
2.20	A cemented hatchery tank located directly below the hatching jars at the Raipur Carp Hatchery	34
4.1	Genital aperture (protruding and swollen) of a mature female rohu.	45
4.2	A dissected catla head from the dorsal side to show the pituitary gland	45
4.3	A recipient catla female being weighed to determine the dose of pituitary extract to be injected.	47

4.4	Carp pituitary gland being homogenized	47
4.5	Intramuscular injection being given to a catla broodfish	47
4.6	A milt collection syringe being used to collect milt from an adult male carp	49
4.7	Stripping of a female and a male Chinese carp.	49
4.8	Fertilized Chinese carp eggs.	49
4.9	Ampoules containing fish pituitary extract preserved in glycerine.	50
4.10	<i>Indjuk</i> fibers arranged on bamboo strips	56
4.11	<i>Kakaban</i> ready for installation in floating position.	56
4.12	Carp hatchlings shortly after hatching showing the yolk sac	59
4.13	Installation of the airlift system in a rotifer pond at the Balai Budidaya Air Tawar (Development, Extension and Training Wing) of the Directorate General of Fisheries, Sukabumi, West Java, Indonesia.	60
5.1	A rectangular bamboo frame for enclosing decaying land vegetation to serve as a pond fertilizer	67
5.2	A holding pen.	72
5.3	Cleaning a holding pen	72
5.4	Sieves of two different mesh sizes made of bamboo to sift and size-grade carp fry before stocking	72
5.5	Size-grading carp fry by sifting through sieves.	72
6.1	Galvanized iron steel boxes lined with latex foam for holding carp seed under oxygen	75
6.2	Latex foam galvanized iron boxes with oxygen cylinder	75
6.3	Method of making plastic bags for fish seed transportation	76
6.4	Method of knotting and sealing a plastic bag.	76
6.5	A container for plastic bags holding live fish under oxygen during transport to prevent inadvertent damage to the bags.	77
6.6	A special fry transport vehicle having agitators to maintain oxygen-rich water.	78
6.7	An open canvas bag (for holding broodfish) for suspension in a water tank to transport live broodfish.	78
6.8	Cloth bag used for transporting broodfish over short distances.	80
6.9	Transporting broodstock for injection	80
7.1	Scale carp: an Asian "wild" race termed "local strain" in South Sumatra, Indonesia.	87
7.2	Scale carp: Chinese big belly carp in Burma	87
7.3	Scale carp: Majalayan strain broodfish at Sukabumi, West Java, Indonesia	87
7.4	Mirror carp: Dinnye's strain Hungarian carp at Baluhar Baor, Jessore, Bangladesh.	87
8.1	Dimensions for cyliandroconical tanks; all have three legs.	100
8.2	Outflow filter for cyliandroconical tanks.	100
8.3	Growth of grass carp postlarvae/fry fed on different diets	108
8.4	Growth of common carp postlarvae/fry fed with dry yeast feed or <i>Artemia</i> plus boiled egg yolk	108
8.5	Effects of different levels of dietary cassava and rice on weight gain of mirror carp fingerlings	109

Preface

This Manual is aimed at providing practical guidance to carp hatchery workers and background information on carp biology and culture which may be inaccessible in areas lacking fisheries libraries. It was prepared as part of a Regional Technical Assistance Project for Research and Training in Aquaculture financed by the Asian Development Bank. It is for this reason that the Manual emphasizes conditions and techniques relevant to the Bank's developing member countries which are actively engaged in carp culture, i.e., predominantly countries in South and Southeast Asia, but the methods described are, in most cases, of wider applicability. The sources of information presented in the Manual include the authors' personal experiences and knowledge, published literature and various other secondary sources, most of which are documented in the text.

The term "hatchery" is considered in this Manual in its enlarged sense as a facility for producing fish fingerlings suitable for stocking in growout ponds. Such a hatchery is a fish farm which incorporates (1) a certain number of ponds for stocking broodfish to prepare them for spawning; (2) a hatchery proper, often an indoor facility for fish spawning, egg incubation, hatching and rearing the hatchlings to postlarval stage; (3) a certain number of nursery ponds used for nursing postlarvae to fry and (4) a certain number of rearing ponds used for rearing fry to fingerlings.

Aquaculture is often considered and generally described in knowledgeable circles as a high-risk bioindustry. The high-risk element arises from chances of loss of the crop at any stage due to disease and/or adverse weather conditions and even, not infrequently, by poaching or large-scale theft. A factor contributing to the high-risk element also arises from the state of scientific and technical knowledge and its field application to individual steps that, in their totality, make aquaculture an industrial enterprise. By and large, carp culture so far is more an art than a science, with packages of empirically developed practices going with the tag of one system or the other, e.g., the Chinese system, Indonesian system, Indian system. The impact of science has just begun to be felt, and a great deal of headway still remains to be made to impart to aquaculture the benefit of multidisciplinary, systems-oriented research which it urgently needs. Such a systems approach has benefitted the poultry industry in the past, with which aquaculture is often compared. For example, hypophysation as a technique of breeding carps, though a big leap forward towards infusion of science into aquaculture, has tended to remain on a hit-or-miss level rather than developing into a foolproof approach to carp breeding based on cause and effect. Similarly, the biological and chemical bases of natural food production in fertilized ponds have still not been fully elucidated and one is left again with package of empirical practices.

There are usually several options for any aquacultural practice. No major breakthrough is yet in sight that could lead to an explosion of carp production comparable to that obtained through high-yielding varieties of certain cereal crops in the allied field of agriculture.

That being the scientific status of aquaculture, writing a manual is beset with decisionmaking problems. All one can do is to state alternatives and options and their advantages and disadvantages, linking them up with geographical and topographical situations, dexterity and the sixth sense of workers, with quite a lot depending on governmental policies and financial input. For example, the labor intensiveness of industrial aquaculture, which most governments of developing countries are likely to emphasize, precludes the adoption of the most efficient systems and the infusion of automation into aquaculture. After all, the economic viability of the practice is the test through which any aquacultural system has to pass.

The definitions of various life-history stages of carps, used throughout this Manual, are given below:

- | | |
|------------------------|--|
| 1. Ovarian eggs or ova | Ova contained in the ovary. |
| 2. Eggs | Fertilized or unfertilized eggs released by fish in the breeding process. |
| 3. Hatchling | Hatched larva not eating exogenous food but carrying its own yolk sac and generally performing only vertical movements. Sometimes split into early and late or advanced hatchling stages depending on age. |
| 4. Postlarva | Larva after absorption of the yolk sac, eating exogenous food and swimming in all directions, generally head forward. Length variable according to species. |
| 5. Fry | Young fish measuring approximately 2.0-2.5 cm in total length. Sometimes split into early and late or advanced fry stages, the latter merging into the early fingerling stage. |
| 6. Fingerling | Young fish measuring approximately from 2.5 to 13 cm in total length. Sometimes split into early and late or advanced fingerling stages. |
| 7. Young fish | Collective name of hatchlings, postlarvae, fry and fingerlings. |
| 8. 0-group fish | Fish less than 12 months old. |
| 9. Yearling | One-year old fish. |
| 10. 1+ | Fish between 1 and 2 years of age. |
| 11. 2+ etc. | Fish between 2 and 3 years of age and so on. |

In this Manual the relevant bionomic features are first described individually for each species. This is to enable the reader to base aquaculture on the known biology of each species and to compare the results of aquaculture with patterns observed in nature. For example, gonad weight and fish fecundity influenced by artificial diets can be compared to fecundity observed in nature, and growth rates obtained by qualitative and quantitative diet regulation can be compared to growth rates occurring in the natural habitat of the fish. Next, the steps which are to be followed—breeding, hatching, hatchling and postlarvae care, fry rearing, fingerling production—and field methods to be applied are described, including available options for every step and discussing the whys and hows of the processes. Thereafter, techniques of transport of live fish seed, carp stocks and their genetics, carp nutrition, food, feeds and feeding and fish diseases, their prophylaxis and therapeutics are described. Further on, what an aquaculture establishment should have by way of equipment, implements, facilities, literature and technical manpower are mentioned. Finally, research problems which beset aquaculture are highlighted so that every establishment may contribute to the growth of science in aid of aquaculture to impart to it the status of a truly science-based industry capable of contributing to the much-needed supply of fish protein for the peoples of Asia and other developing regions.

This Manual is addressed to carp hatchery managers and its objective is to furnish practical technical guidance to hatchery personnel. The economic viability of a carp hatchery as a whole and the economics of hatchery operations are not given in this Manual. Their exclusion is not because the subjects are less important but because it is very difficult to collect factual monetary data on the cost-benefit relationships of aquaculture operations notwithstanding the rather difficult to quantify social benefits (such as rural health) of aquaculture in welfare societies. The very fact that carp seed production is being increasingly adopted as a professional gainful occupation in the rural sector in the developing countries bears enough testimony of the economic viability of some carp hatcheries.

V.G. Jhingran.
R.S.V. Pullin

Chapter 1

Biology of Cultured Carps

The species of fish dealt with in this Manual, either individually or as a group, are commonly called carps. The species referred to are primarily seven in number and are often grouped on the basis of their natural geographical occurrence: the so-called Chinese carps, which include the grass carp, *Ctenopharyngodon idella*; the silver carp, *Hypophthalmichthys molitrix* and the bighead carp, *Aristichthys nobilis* and the so-called Indian major carps, which include catla, *Catla catla*; rohu, *Labeo rohita*; and mrigal, *Cirrhinus mrigala*. The seventh species is the common carp, *Cyprinus carpio*. Each of these species, by common parlance, is a carp. Ordinarily, however, the expression "the carp" or "carp", when used in singular for an individual fish, generally connotes the common carp, *Cyprinus carpio*, rather than any other cyprinid species. Other fishes are known by their own individual particular names like silver carp, grass carp, catla, rohu, etc. Taxonomically, carps belong to the family Cyprinidae. According to Berg (1940), they fall under the following systematic classification:

Phylum	Vertebrata
Subphylum	Craniata
Superclass	Gnathostomata
Series	Pisces
Class	Actinopterygii
Order	Cypriniformes
Division	Cyprini
Sub-Order	Cyprinoidei
Family	Cyprinidae
Sub-Family	Cyprininae

Following is a brief description of the significant biological characteristics relevant to aquaculture viz., geographical distribution, hybrids, food, growth, size and age at first maturity and fecundity, especially important from the point of view of operating a hatchery, of each of the species of carps dealt with in this Manual.¹

Grass Carp

Grass carp (Fig: 1.1) is a natural inhabitant of the flatland rivers of China and the middle and lower reaches of river Amur in the USSR and the fish has been introduced into many other countries in recent times. In some of the countries the main

¹The sources of data on the common carp and the Indian major carps catla, rohu and mrigal are mainly the FAO Fisheries Synopses Numbers 31(1) (1966), 32 (1966), 111 (1975) and 120 (1979), respectively. While they are included in the cited references (Chapter 14), the far too many original sources of literature mentioned in the synopses are not individually indexed. Those for data on the Chinese carps are, however, mentioned in cited references in the Manual, there being no synopsis of biological data on any of the Chinese carps so far.

purpose of its introduction, in addition to culture, is biological aquatic weed control in natural waterways, lakes and man-made lakes.

Grass carp, like other cyprinids, has a toothless mouth but has specialized pharyngeal teeth for rasping aquatic vegetation. These teeth occur in two rows, the upper consisting of two small teeth on either side and the lower of strong comb or file-like teeth comprising four on the right and five on the left pharyngeal bone. In fishes of total length 30 cm and below, the lower pharyngeal teeth have a serrated cutting surface, while in larger fish, the teeth are thicker and have double flattened serrated cutting and rasping surfaces. These patterns of teeth structure are associated with the change in the feeding habit. Large fishes are able to masticate the leaves of tough land plants such as fibrous grasses.

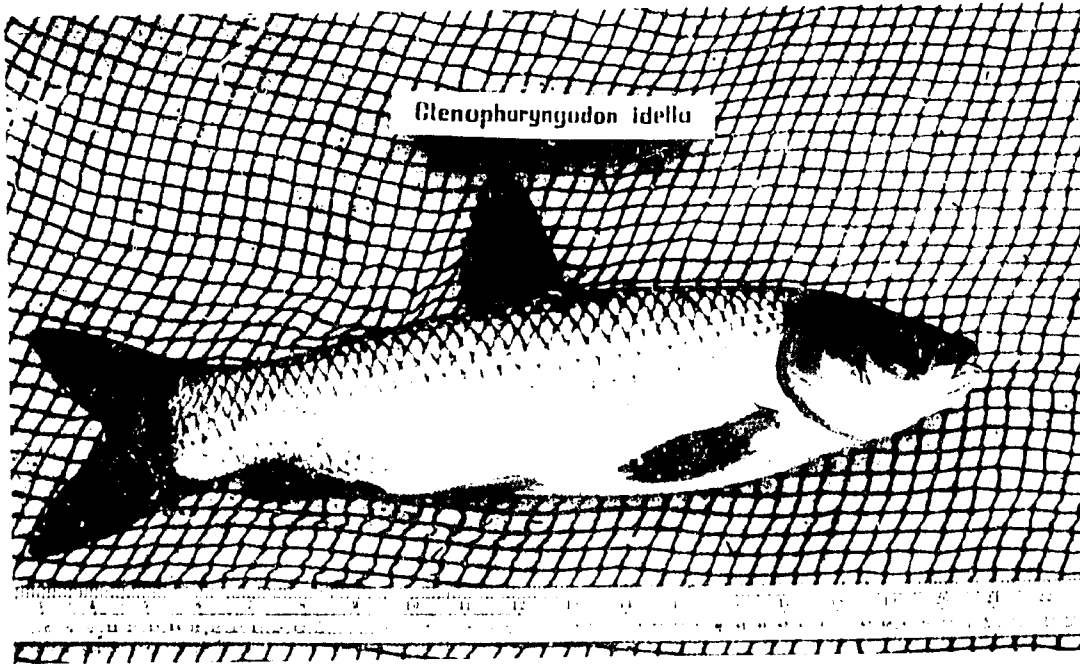

Fig. 1.1. Grass carp, *Ctenopharyngodon idella*.

Digestion in the grass carp is said to be incomplete and about half the food material ingested is excreted as feces which, it is believed, can support directly or indirectly a large biomass of other species of fish.

The natural food of grass carp fry about 7-9 mm long is protozoa, rotifers and nauplii to which diet Cladocera and copepods are added as they grow to about 12 mm length. Cladocera, copepods and benthic algae form the diet of fry 13-17 mm long to which organic detritus is added up to a length of about 23 mm. As the fry grow to about 30 mm length, phytoplankton and minute algae become conspicuous additions to the diet. For fish above 30 mm, the natural diet is virtually exclusively macrovegetation, tender aquatic weeds like *Wolffia* initially and a wide variety of other aquatic macrovegetation and even softer land plants as the fish grows. Among the macrovegetation, the preferred weeds in the different regions of the world are: *Wolffia*, *Lemna*, *Spirodela*, *Hydrilla*, *Najas*, *Ceratophyllum*, *Chara*, *Potamogeton*, *Vallisneria* and *Myriophyllum*.

The fry and larger fish take to substances like cereal brans, oilcakes, silkworm pupae, kitchen refuse, night soil and dung which are often given as supplementary food. The estimated conversion ratios² of a few selected food items are shown in Table 1.1.

In natural waters, grass carp attains a length of 15 to 30 cm weighing 225 g to 650 g at the end of first year; a length of 60 cm and a weight of 1.8 to 2.3 kg at the

²Weight of food:gain in whole wet weight of fish.

end of second year. After four years, the weight may be 4.5 kg. In the Yangtze and West River systems, fish weighing 9 to 13 kg are common and fish weighing more than 20 kg have been caught.

Under culture conditions, growth is a function of stocking rate and feeds given and their conversion rate, competition with other fish co-stocked with grass carp and environmental conditions. Hickling (1967), comparing the daily growth of grass carp in different countries, observed it to be 2.8 g in Siberia, 3.3 in Turkmenia and south China, 6.6 to 9.8 in Israel, 4.7 in India and 8.3 to 10 in Malacca. In Chinese ponds, grass carp attains a weight of 225 to 680 g in first year, 1,200 to 2,300 g in second, 2,700 g in third and 3,800 g in the fourth year. Woynarovich (1968) observed the growth of grass carp in China, USSR and some east European countries to be as shown in Table 1.2.

Age at which grass carp attains maturity varies greatly with climate and environmental factors, especially temperature. In China, the approximate age at maturity of grass carp is 15,000 degree($^{\circ}$ C)-days, counting only those days when water temperature exceeds 15 $^{\circ}$ C. However this may not apply to other locations (see Table 1.3).

Table 1.1. Conversion ratios of a few items of grass carp feeds.^a

Feed item	Conversion ratio
Rice bran/wheat bran	4-6:1
Peanut and soya bean cake	3-4.5:1
Silkworm pupae	1.1:1
Silkworm faeces	17:1
Sugarcane leaves	40:1
Mixed vegetables	33:1
Pig dung	45:1
Duck dung	43:1

^aAdapted from Chang et al. (1983).

Table 1.2. Growth of grass carp in some countries.^a

Country	Age groups		
	0	I	II
	Weight of age groups (g)		
China	30-100	250-500	1,500-3,000
USSR (Moscow Area)	15-25	200-250	800- 900
Turkmenia	20-420	360-850	1,940-3,100
Rumania	15-25	200-850	800-1,800
Hungary	50-150	550-1,200	1,500-6,000

^aFrom Woynarovich (1968).

Lin (1935) reported that in China a female grass carp weighing 7 kg had 100,000 ova. Inaba et al. (1957) estimated 485,000 ova in a grass carp weighing 7.1 kg. Fecundity of grass carp in relation to fish and ovary weight has been studied, as shown in Table 1.4. Fish weighing 4,766 to 7,036 g had 308,000 to 618,100 ova, about 82 ova per gram body weight of the fish and 610 ova per gram weight of the ovary. The ovarian eggs of grass carp have a diameter varying between 1.19 and 1.37 cm. A fully swollen water-hardened spawned egg of grass carp has a volume of approximately 0.055 ml. A grass carp hatchling after absorption of the yolk sac weighs approximately 0.0022 g.

The fish breeds during monsoon months in the flowing waters of its natural habitat, the rivers, but does not spawn naturally in the static waters of ponds and tanks. The various methods employed for induced spawning are described in Chapter 4.

Silver Carp

Silver carp (Fig. 1.2) naturally occurs in the river systems, Yangtze, West River, Kwangsi and Kwangtung in south and central China and in the Amur Basin in USSR and the species has been introduced into many countries in recent years for aquaculture.

One- to three-day old fry, when about 7-9 mm long, mainly feed on zooplankton, rotifers and copepod nauplii. Their diet expands as the fry grow to include copepods,

Table 1.3. Size and age at first maturity of grass carp in different countries.^a

Country	Age at maturity (years)	Weight (kg)
China		
South	4-5	6-8
Central	4-5	6-8
Northeast	6-7	6-8
India		
Pond-bred	2	1.5
Wild	3	4-8
Malaysia	1-2	2.3-3.2
Taiwan	4-5	3 or more
USSR		
Turkmenia	3-4	—
Ukraine	8-9	2.7-3.8
Siberia	8-9	6.5-7.0
Moscow	10	6.5-7.0

^aAdapted from Chang et al. (1983).Table 1.4. Size and fecundity of grass carp.^a

Total length (cm)	Weight of fish (g)	Weight of ovaries (g)	Weight of fish: weight of ovaries	Total no. of eggs	Average diameter of ova (mm)
73.8	4,766	540	6.7 : 1	372,600	1.21
75.0	5,830	880	6.6 : 1	441,700	1.31
75.8	4,880	744	6.5 : 1	563,900	1.19
78.6	5,476	656	8.3 : 1	396,200	1.35
78.9	5,724	1,129	5 : 1	618,100	1.30
79.2	7,036	553	12.7 : 1	308,800	1.33

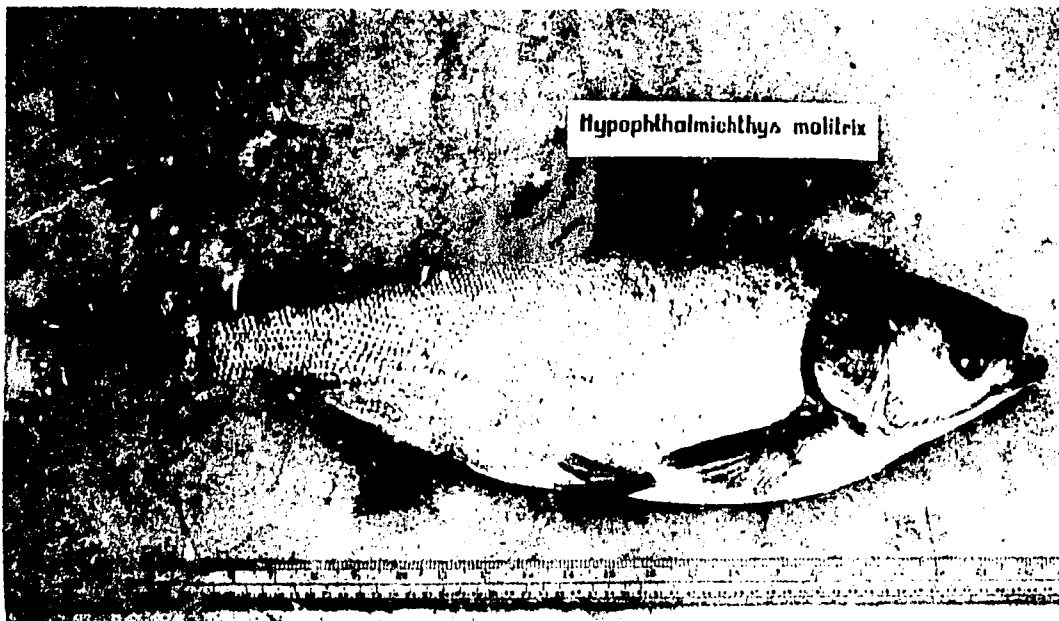
^aFrom Alikunhi and Parameswaran (1963).Fig. 1.2. Silver carp, *Hypophthalmichthys molitrix*.

Cladocera and phytoplankton. Still larger fry and adults feed on Flagellata, Dinoflagellata, Myxophyceae, Bacillariophyceae, etc., primarily phytoplankton and secondarily zooplankton. The fish shows certain anatomical and morphological modifications in correlation with its phytoplanktophagous feeding habit. The length of the gut of the adult fish is 15 times the body length. The gills of silver carp have a complex network and profusion of closely set gill rakers.

There is little information available on the growth rate of silver carp in rivers of its natural occurrence. Under culture conditions, growth rate is a function of stocking rate, natural food available and feeds given, competition with other species in polyculture, conversion rate of feed and environmental conditions. Under a given set of conditions, the growth rate of fry of silver carp is extremely high in the first 10 days, the fish doubling its weight every second day and becoming about 19 mm long weighing 0.09 g in 10 days, 47 mm long weighing 1.1 gm in 20 days and 17 cm long weighing 5.5 g in 60 days. Absolute weight increases 0.001-0.02 g/day in the first 10 days and 4.2 g/day during the fingerling stage. Silver carp attains highest growth rate in length in the second year of life and maximum growth rate in weight in the third year. Growth in both length and weight declines sharply after the third year, by which period the fish may weigh as much as 2,780 g, gaining weight at the rate of 6.3 g/day. The length and weight of silver carp under certain conditions of culture may be as shown in Table 1.5 below.

Of the environmental factors, temperature exercises maximum effect on the maturity of silver carp. The age at first maturity of silver carp can be approximated by the same formula as for grass carp. However, this may not be applicable in locations other than China.

The age and size at sexual maturity of silver carp reported from China and Rumania are shown in Table 1.6.

Table 1.5. Growth of silver carp.^a

Age (years)	Body length (cm)	Weight (g)
2	50.0	1,803
3	57.6	4,650
4	60.3	5,340
5	63.0	6,400

^a Adapted from Chang et al. (1983).

Table 1.6. Age and size at sexual maturity of silver carp.

Country	Sexual maturity		Authority
	Age (years)	Weight (kg)	
South China	2-3	2-5	Kuronuma (1968)
Central China	4-5	2-5	Kuronuma (1968)
North China	5-6	2-5	Kuronuma (1968)
Rumania	6-9	6-8	Woynarovich (1968)

Alikunhi and Parameswaran (1963) reported the fecundity of silver carp weighing 3.18 kg to 8.51 kg, as 145,000 to 2,044,000. The number of eggs per g body weight was 171 and per g ovary weight, 292. The fecundity of silver carp at different sizes and ages, as observed at the Pond Culture Division of the Central Inland Fisheries Research Institute (CIFRI), Cuttack, India is shown in Table 1.7.

The eggs from the yearlings of silver carp, 0.6 to 2.4 kg in weight, measured, on average, 1.20 mm in diameter, whereas those of 4-year old fish were about 11% larger. A fully swollen, water-hardened silver carp egg has a volume of about 0.07 ml. A silver carp hatchling after its yolk sac is absorbed weighs approximately 0.0031 g.

The fish breeds naturally during April-July in the flowing waters of its natural habitat, the rivers of China. In the Tone River in Japan, where the fish has established itself, it spawns naturally during June-July. At Cuttack in India, pond-reared fully ripe males are available during April-May and the females, a little later, during May-July (Alikunhi et al. 1963). The fish does not spawn naturally in ponds and

Table 1.7. Fecundity of silver carp of different sizes and ages.^a

Particulars of stock	No. examined	Range and average Length (cm)	Range and average Weight (g)	Percentage of ovarian weight, range and average	Ova per g body weight range and average	Ova per g ovary weight range and average	Ova diameter range and average (mm)
One-year old induced bred	9	38.8-57.5 (52.2)	591-2,430 (1,734)	9.6-24.0 (14.4)	75-252 (167)	788-1,768 (1,165)	1.07-1.36 (1.20)
Two-year old Tone river stocked reared in Cuttack, India, during 1959-61	8	56.5-74.0 (65.9)	3,178-6,523 (4,572)	14.3-34.9 (25.6)	46-313 (194)	318-951 (732)	—
3+ stock	14	63.5-82.8 (74.7)	4,994-8,512 (6,320)	13.6-27.2 (20.2)	100-228 (161)	518-1,031 (801)	1.21-1.36 (1.255)
4+ stock	2	80.2-82.5 (81.4)	6,294-7,491 (7,208)	22.0-24.0 (23.0)	160-180 (170)	667-822 (745)	1.31-1.35 (1.33)

^aFrom Alikunhi and Sukumaran (1965).

tanks. The various methods employed for its induced breeding are described in Chapter 4.

Wu and Chung (1964) stated that the fecundity of the pond-reared breeders of Chinese carps in Kwangtung Province, China, is high, usually about 1 million eggs per kg of body weight. Kuronuma (1968) stated that silver carp from Tone River, Japan, 88.0 to 98.5 cm in length and 9.5 to 11.0 kg in weight, produced between 1,098,000 and 1,392,000 eggs after injection of pituitary material.

Bighead Carp

Bighead carp (Fig. 1.3) is the natural inhabitant of the river systems Yangtze, West River, Kwangsi and Kwangtung of south and central China and the species has been transplanted into many countries in recent years.

Larvae feed mainly on unicellular planktonic organisms, nauplii and rotifers. Fry and adults feed on diverse forms of planktonic life, mainly zooplankton as well as Bacillariophyceae, Flagellata, Dinoflagellata, Myxophyceae, etc. The alimentary



Fig. 1.3. Bighead carp, *Aristichthys nobilis* (reproduced from Huet 1972).

canal of this fish is much shorter, size for size than that of silver carp, a difference brought about by the necessity of having to digest primarily zooplankton in bighead carp and phytoplankton in silver carp. The food of this fish resembles more that of the Indian major carp catla, which is also predominantly a zooplankton feeder. A considerable measure of competition for food may be expected between bighead carp and catla in polyculture if these two species are grown together in the same pond.

Little information is available on the growth rate of bighead carp in rivers of its natural occurrence. In aquaculture operations, growth rate would depend on rate of stocking, food available naturally from aquatic fertilization and supplied supplementarily, competition with other species co-stocked, conversion rate and environmental conditions. Under a given set of conditions, the hatchlings, which on emergence may be 7.5 mm long weighing 0.002 g, in 10 days may become 13 mm long weighing 0.09 g. The rate of growth of fingerlings may be 6.3 g/day and of young adults, 14.7 g/day.

The maximum growth in length, as in the case of silver carp, occurs in second year and maximum growth in weight, in third year. The length and weight of bighead carp in the first five years of its life, under certain conditions, may be as shown in Table 1.8.

The pattern of attainment of maturity follows the same principle as that of silver carp and grass carp. The fecundity is 126 eggs per gram of body weight. Table 1.9 shows the size and age at first maturity of bighead carp in different countries.

The fish breeds during monsoon months in the flowing waters of its natural habitat, the rivers, but does not spawn naturally in the static waters of ponds and tanks. The various methods employed for induced spawning are described in Chapter 4.

Table 1.8. Growth of bighead carp.^a

Age (years)	Body length (cm)	Weight (g)
2	63.0	3,250
3	74.6	10,700
4	75.1	10,900
5	77.8	11,800

^aAdapted from Chang et al. (1983).

Table 1.9. Size and age at first maturity of bighead carp in different countries.^a

Country	Age of maturity (years)	Weight (kg)
China		
South	3-4	5-10
Central	4-5	5-10
Northeast	6-7	5-10
Taiwan	3-4	5 or more
USSR	5	-

^aAdapted from Chang et al. (1983).

Common Carp

The common carp (Fig. 1.4) has four subspecies (Kirpichnikov 1967), viz. *Cyprinus carpio carpio* of the European-Transcaucasian area; *C.c. aralensis* of the mid-Asian region; *C.c. haematopterus* of the Amur-Chinese or Far Eastern region and *C.c. viridivio-laceus* of north Vietnam. According to Gunther (1868), the common carp is a native of the temperate regions of Asia, especially of China. According to Schäperclaus (1933), the fish was originally a native of the rivers draining into the Caspian Sea and the Black Sea. According to Okada (1960), the fish, which originated from central Asia, was introduced in ancient times into China

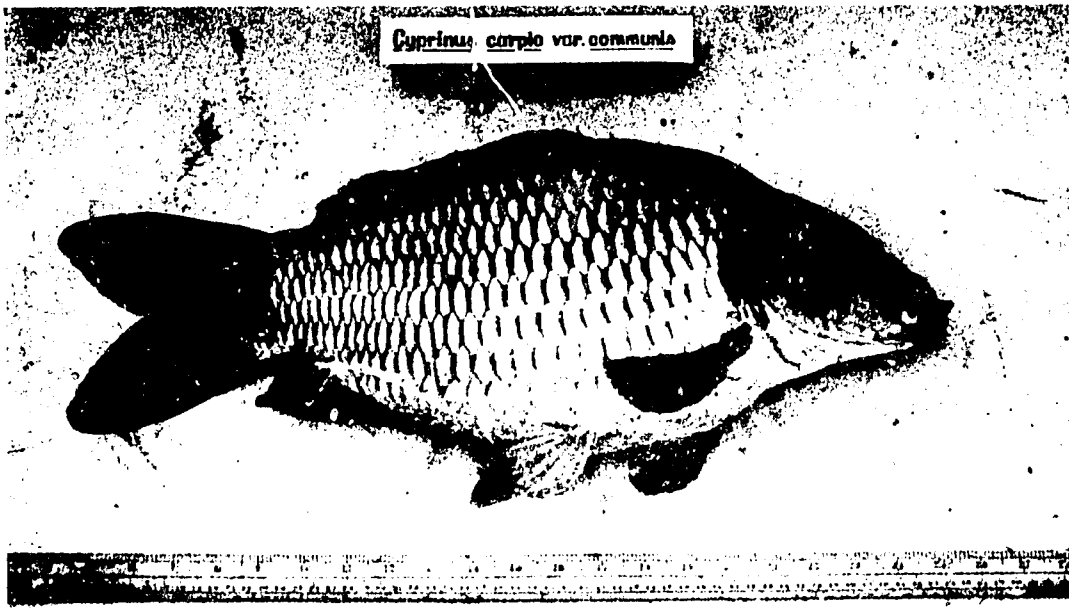

Fig. 1.4. Common carp, *Cyprinus carpio* ("big belly" variety).

and Japan in the oriental region and into Greece and Europe through Rome. The original natural distribution of common carp was probably restricted to a narrow belt in central Asia within latitudes 35°-50°N and longitudes 30°-135°E and altitude generally 300 m above mean sea level. It has been transplanted into scores of countries, so much so that it now enjoys the status of a virtually global fish and its culture is very widespread.

There are numerous varieties and subvarieties or strains of common carp. The well-known variety of the Kwantung and Kwangsi regions of China is the "big belly carp" and of the Yangtze region, the "long bodied carp". The well-known Indonesian orange-colored carp (*Cyprinus carpio* var. *flavipinnis* C.V.) has been split into a number of subvarieties, such as the lemon-colored Sinyonya and the gold brown Katjera Domas. There is also the green variety in Indonesia, the "Punten carp" with genetic traits which are believed to be stabilized. The "Majalayan" strain of West Java is also a greenish variety. The mirror carp (*Cyprinus carpio* var. *specularis*) of the Galician variety or of the Franconian variety were transplanted into Indonesia in the first half of the 20th century and are distinct from the Aischgrunder (Germany) or Royale (France) varieties. The Russian mirror carp (*Cyprinus carpio* var. *specularis*) is now split into two varieties, the scale carp (*C.c.* var. *communis*) and the leather carp (*C.c.* var. *nudus*). The other varieties of common carp are the Japanese races which go by the name of Asagi and Yamato; Ropsha and Kursk of USSR; Dinnyeš of Hungary and Nasice of Yugoslavia. Further information on carp genetics is given in Chapter 7.

Postlarvae up to 10.0 mm long feed on, among other organisms, *Ceriodaphnia*, *Moina*, *Cyclops* and nauplii. In the guts of 10- to 20-mm long fry, are found the remains of *Cyclops*, rotifers, *Ceriodaphnia*, *Moina*, nauplii, *Chydorus*, *Microcystis*, *Euglena*, *Oscillatoria*, diatoms and *Closterium*. Twenty- to 100-mm long common carp feed on, among other organisms, *Diaptomus*, *Cyclops*, rotifers, *Diaphanosoma*, *Moina*, *Ceriodaphnia*, ostracods, insects including chironomid larvae, *Euglena* and *Closterium*. Common carp bigger than 10 cm thrive on decayed vegetable matter containing bottom dwelling organisms, notably tubificids, molluscs, chironomids, ephemeroptera and trichoptera. Common carp dig and burrow into pond embankments and sides in search of organic matter. The fish gulp in mud from which digestible matter is sifted and the rest rejected, a habit which often makes pond water turbid.

The growth rate of common carp under culture is a function of the variety cultured, rate of stocking, quality and quantity of feed supplied and competition with other fish in the case of polyculture. Under given conditions, growth of common carp in different countries is as described in Table 1.10.

The size and age of common carp at first maturity in different countries are as shown in Table 1.11. Some fecundity data are shown in Table 1.12.

The males have remarkably highly developed testes and some have the abdomen bulging as conspicuously as in the case of gravid females. The weight of testes in some males may be as high as 20 to 30% of the total body weight.

Common carp breeds naturally in its natural habitat, the rivers as well as in ponds and tanks. The eggs are adhesive and the fish requires suitable floating substances for attachment of eggs.

Breeding frequency and methods of breeding common carp in aquaculture operations are described in Chapter 4.

Table 1.10. Growth of common carp in various countries.^a

Country	1st year	Weight (g) at the end of		
		2nd year	3rd year	4th year
China	300	900	1,500	2,000
Malaysia) Thailand) Indonesia)	400	800	—	—
Europe	35-50	350-500	1,250-1,500	2,500
England	15	200	600	1,300

^aFrom Alikunhi (1966).

Table 1.11. Size and age at first maturity of common carp under different climatic conditions.^a

Country	Water temperature during spawning season (°C)	Age (years)	At first maturity Length (cm)	Weight (g)	Spawning season
Europe	15-18	3-4	40-45	1,500-2,500	May-June
USSR	17-19	2-5			April-May
China		2-3			
Japan	12-30	0.2-0.3	30-38	500-900	April-June
Indonesia	19-30	1-1.5	30-40	1,000-2,000	Year round
Thailand	26-29	1-1.5			
Malaysia		1-1.5			
India					
a) Plains	18-35	0.5	15-20	80-170	Year round
b) Hills		1.0	37-46	908-1,360	Year round
Israel	23-30	1.0			March-August
USA (South)	20-25	1.4			March-June

^aFrom Alikunhi (1966).

Table 1.12. Absolute and relative fecundity of common carp in India.^a

Length (cm)	Total weight (kg)	Ovaries: Percentage of total weight		No. eggs	No. eggs/g ovary
		Range	Average		
15-25	0.058-0.290	8.7-32.9	20.7	6,360-25,942	517-1,388
25-35	0.309-0.795	3.6-37.9	18.0	46,648-60,720	437-1,793
35-45	0.817-2.043	7.5-32.5	18.0	120,448-146,328	549-1,697
45-55	2.143-3.632	7.0-32.3	20.6	281,790-551,580	440-941
55-65	2.902-7.600	5.3-37.8	24.2	776,020-1,748,000	563-912
Over 65	13.62	26.7		2,045,552	811

^aFrom Alikunhi (1966).

Catla

Catla (Fig. 1.5) is the natural inhabitant of the freshwater sections of the rivers of northern India, Pakistan, Bangladesh and Burma. Its favorite habitat is the deep pools of the rivers of north India. The species has been transplanted into some of the rivers of peninsular India, notably River Cauvery and in more recent times, into Sri Lanka and China. Mixed seed of Indian major carps, which generally includes catla, rohu and mrigal, has been exported to several countries, the details of which are given in Table 1.13.

While no distinct races or varieties of catla are known, catla, as a species, is often confused with an allied form occurring in Thailand, *Catlocarpio siamensis* (Boulenger) due to their extraordinary superficial resemblance, more especially in the enormous heads of both.

Five hybrids have been produced artificially in India, namely male catla x female rohu, male catla x female *Labeo calbasu*, male catla x female mrigal, male rohu x female catla and male *Labeo fimbriatus* x female catla. In 1962, one pair of catla-rohu hybrids was induced to spawn by injecting pituitary hormone, which resulted in successful production of a second generation of the hybrid. In 1960, several hundred golden colored catla were obtained from one induced-bred specimen, and when the colored catla were interbred, all the progeny were found to be colored.

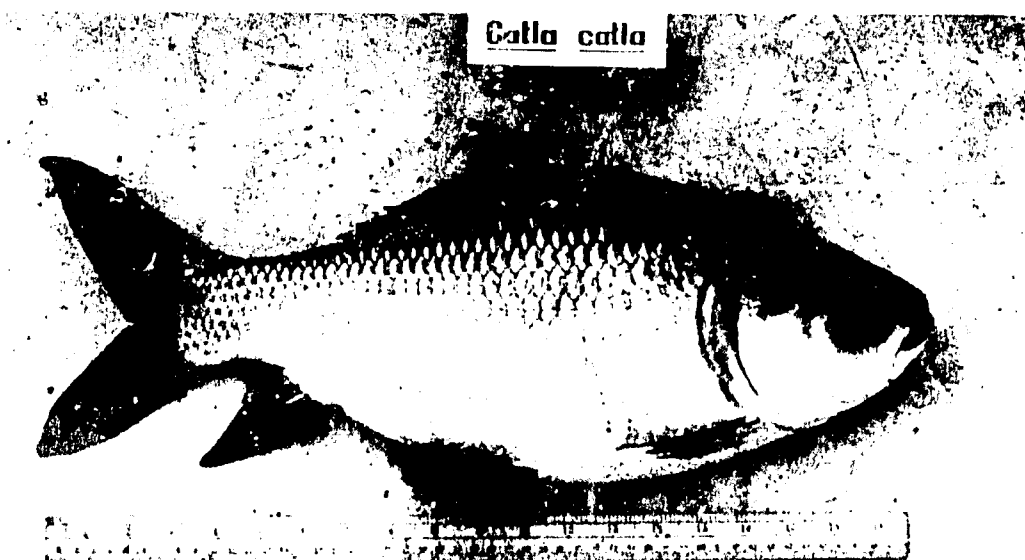

Fig. 1.5. Catla, *Catla catla*.

The dominant occurrence of zooplankton in the gut of catla indicates that it is mainly a water column feeder. The incidence of organic detritus, mingled with sand, mud and rooted aquatic plants indicates a bottom browsing habit as well. The presence of certain unattached submerged floating vegetation points out that the fish also explores the midlayers of water. The natural foods of juveniles and adult catla are shown in Table 1.14.

Table 1.13. Export of Indian major carp seed by Messrs. Fish Seed Syndicate, Calcutta.^a

Country where exported	Year of export	Total quantity of seed sent (si. up to 30 mm)
Japan (Tokyo)	1961	6,000
Malaysia (Penang)	1957	4,700
	1959	6,000
Malacca	1957	2,620
	1961	300
Sarawak	1970	10,000
Nepal	1957	60,000
	1958	35,000
Philippines	1965	15,000
USSR (Moscow)	1966	3,000
Southern Rhodesia	1965	6,600

^aFrom Khan and Jhingran (1975).

Table 1.14. Natural food of juvenile and adult catla.^a

Food item	Percentage of occurrence	
	Juvenile	Adult
Crustacea	79.68	64.20
Algae	9.68	30.06
Macrovegetation	1.03	2.41
Rotifers	5.66	1.19
Insects	2.87	0.99
Protozoa	0.50	0.01
Molluscs	0.03	—
Polyzoa	0.02	—
Decayed organic matter	0.13	0.60
Sand and mud	0.40	0.54

^aAdapted from Natarajan and Jhingran (1961).

Catla is the fastest growing of the Indian major carps. In natural waters, catla attains a length of 295 mm (weight 354 g) in the first year, 514 mm (weight 2,193 g) in the second year, 716 mm (weight 6,501 g) in the third year, 923 mm (10,282 g) in the fourth year and 917 mm (weight 14,665 g) in the fifth year.

Growth of catla under culture conditions, as revealed in literature, is summarized in Table 1.15.

Catla attains first maturity in the second year of life. Alikunhi (1957) mentioned that in ponds catla becomes mature when 22 months old. Natarajan and Jhingran (1963) estimated that catla from River Yamuna at first maturity were in the second year age-group.

The length at which catla attains first sexual maturity has been stated by different workers as indicated below.³

Chacko and Kuriyan (1948, 1950)	559 mm
Alikunhi (1957)	457 mm
Menon et al. (1959)	550 mm
Natarajan and Jhingran (1963)	442 mm

Khan (1924) found 400,275 eggs in a specimen of catla weighing 5.1 kg. The number of eggs per kg body weight was estimated by him to be 77,832. Natarajan (personal communication) found the fecundity of catla to vary from 230,831 to 4,202,250, depending upon the length and weight of the fish and the weight of the ovary as shown in Table 1.16.

³Jhingran (1966). Published with the permission of Food and Agriculture Organization, United Nations.

Table 1.15. Growth of catla under culture conditions.^a

Length and/or weight attained by catla	Duration age and/or initial length	Length and/or weight attained by catla	Duration age and/or initial length
279 mm/396.9 g	May 1875 to 22 September 1875	76 mm to 102 mm/month	First six months
432 mm	Four months: initial length 102 mm to 229 mm	10.9 kg 18 kg	Two years Three years
305 mm	Six months: initial length 127 mm to 254 mm	381 mm to 457 mm 508 mm in condition of under-stocking/907 g	One year
457 to 610 mm	One year	572 mm/3.6 kg	Nine-and-one-half months
305 mm/510.3 g	Two-and-one-half months	457 mm to 610 mm	One year from initial length 51 mm to 76 mm
660 to 737 mm/about 4 kg	First year	600 mm } 950 mm } 1120 mm }	One year Two years Three years
910 mm to 1.8 m/13.5 to 22.4 kg	Second and third year	320 mm } 530 mm } 700 mm }	One year Two years
254 mm	Five months		
686 mm/3.2 to 4.1 kg	One year		

^aAdapted from Jhingran (1966).

Table 1.16. Relation of egg number to body size and age of catla.

Age of fish (years)	Total length (mm)	Weight of fish (g)	Weight of ovary (g)	Number of ova	Number of ova per gram weight of	
					Body	Ovary
3+	783	11,329.0	301.1	230,831	20	767
3+	795	10,875.4	424.4	348,220	32	821
3+	795	14,373.4	3,005.1	2,348,351	163	781
4	840	13,013.4	3,118.4	2,963,125	228	950
5	923	11,772.6	2,239.7	2,073,065	176	926
5	925	17,095.0	4,422.6	4,202,250	246	950
5	935	18,909.4	2,608.0	2,432,390	126	933
5+	950	18,455.8	3,118.5	3,077,900	167	987

The spawning season of catla coincides with the southwest monsoon in north-eastern India and Bangladesh, where it lasts from May to August and in north India and Pakistan, from June to September. In south Indian rivers, the spawning season appears to be somewhat variable as shown below:

Authority	Spawning Season ^a
Chacko and Kuriyan (1948)	July-November
Chacko and Kuriyan (1950)	End of May-End of October
Alikunhi et al. (1952)	Twice a year, once each during southwest and northeast monsoons
Menon et al. (1959)	June-September
Hora and Pillay (1962)	Twice a year during monsoons

^aFrom Jhingran (1966). Reproduced with the permission of Food and Agriculture Organization of the United Nations.

After spawning, the ovaries are in spent condition, flaccid and bloodshot, with a few dead detached ova lying in the lumen of the ovary.

A fully swollen, water-hardened egg of catla has a volume of approximately 0.08 ml. A catla hatchling after its yolk sac is absorbed weighs approximately 0.0025 g.

Rohu

Rohu (Fig. 1.6) is the natural inhabitant of freshwater sections of the rivers of north India; the Rivers Narmada, Tapti and Mahanadi in central India and rivers of Pakistan, Bangladesh, Burma and the Terai region of Nepal. It has been transplanted into some of the rivers of peninsular India and Powai Lake, Bombay. Rohu has also been transplanted to Sri Lanka and to Mauritius. Mixed along with the seed of catla and mrigal, rohu has been exported to USSR, Japan, Philippines, Malaysia, Nepal and some countries of Africa, during the years 1957 to 1970. The details may be seen in Table 1.13.

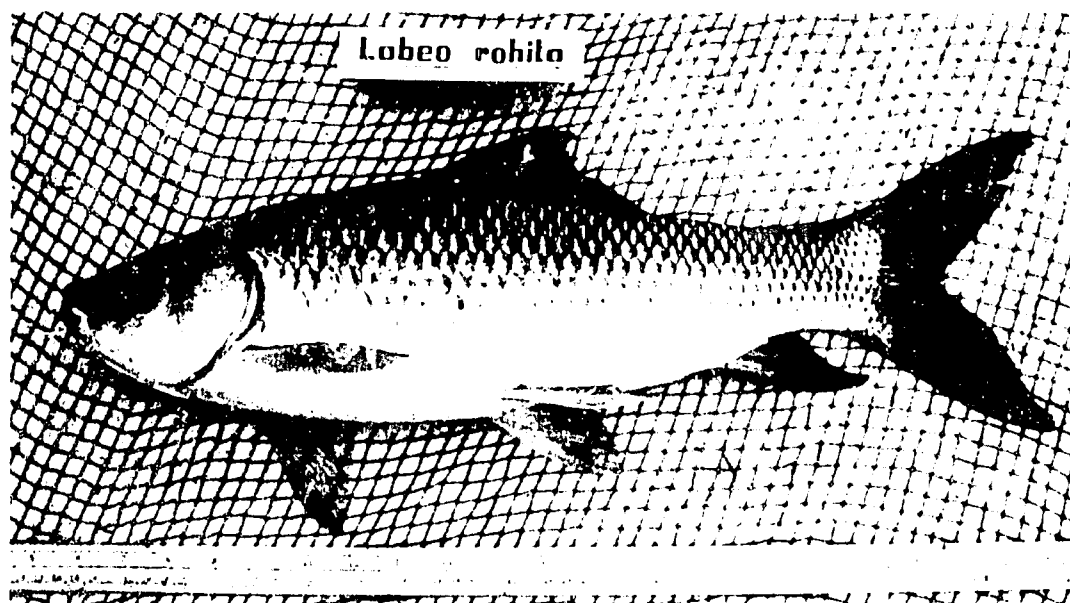

Fig. 1.6. Rohu, *Labeo rohita*.

The interspecific hybrids involving rohu are: (1) male rohu x female *Labeo calbasu*, (2) male *Labeo calbasu* x female rohu and (3) male *Labeo bata* x female rohu. The intergeneric hybrids involving rohu and Indian major and minor carps are: (1) male catla x female rohu, (2) male rohu and female catla, (3) male rohu x female mrigal, (4) male mrigal x female rohu, and (5) male *Cirrhinus reba* x female rohu. The first mentioned intergeneric hybrid, male catla x female rohu, is perhaps the most promising which combines the quick growth of catla and small head of rohu. The intergeneric hybrids produced between rohu and Chinese carps are: (1) male bighead x female rohu, (2) male grass carp x female rohu, (3) male rohu x female grass carp and (4) male rohu x female silver carp. Most of the hybrids between rohu and Chinese carps die before or on the first day of hatching, the longest survivors (for two weeks) are rohu x grass carp hybrids. The intergeneric hybrids between male *Cyprinus carpio* and female rohu, though they survive, are found to be sterile.

Rohu is a bottom and column feeder and prefers to feed on plant matter including decaying vegetation; it is less adapted to take zooplankton than even mrigal. Utilization of plant matter is much better in mrigal and rohu than in catla. Rohu fingerlings 100-250 mm long subsist on unicellular and filamentous algae (15%), rotting vegetation (55%), rotifers and protozoans (2%) and crustaceans (8%). The rotten vegetation component in the food increases in bigger fish.

The sizes attained by rohu at different ages in natural waters are given in Table 1.17.

Under culture conditions, highly variable growth has been mentioned by different workers. It is a very quick growing fish though having a somewhat slower growth rate than catla. Records of growth of rohu, as revealed in literature, are presented in Table 1.18.

Rohu attains maturity towards the end of the second year in ponds (Ali-kunhi 1957). It has been observed at Cuttack, India that a certain percentage of both males and females reached sexual maturity in one year only. The average size of maturity was 292 mm/282 g in one pond and 348 mm/500 g in the other pond. One of the smallest ripe female rohu has been reported to measure 26 cm in length and 250 g in weight in ponds at Cuttack. It is reported that rohu matures in Bangladesh at the age of 3-4 years. Khan (1972) estimated the age at first maturity of rohu by examining the gonadal condition of fish collected from the Aligarh (India) market over a period of 18 months from July 1968 to December 1969. The gonads started developing during the month of February, the ripe stage was reached during June and July and finally spent individuals were found in late July and early August.

Table 1.17. Sizes attained by rohu at different ages of its life in natural waters.^a

Age (years)	Length (mm)
1	310
2	500
3	650
4	740
5	800
6	850
7	890
8	920
9	940
10	960

^aAdapted from Khan and Jhingran (1975).

Table 1.18. Growth of rohu under culture conditions.^a

Length and/or weight attained by rohu	Duration: age and/or initial length
437.5 mm/1.23 kg	9-1/2 months
337.5 mm/0.68 kg	6-1/4 months
200 mm	30 days
650 mm	One year
380-480 mm/680 g	One year
650 mm	One year
340-400 mm	One year
350-450 mm/675-900 g	First year
2.6 kg/5.4 kg	Second year

^aAdapted from Khan and Jhingran (1975).

The gonado-somatic index gave the same information. During the spawning season, males were found to mature earlier than females. The larger-sized individuals were also found to mature earlier than the smaller ones. The minimum age at first maturity for both the sexes was two years while complete maturity was reached by males at age four years and by females at age five. The fifty-percent maturity point was 2.7 years for males and 2.9 years for females. The minimum size at first maturity of males was 46.2 cm and 100 percent maturity was found in the 650 mm length group. The smallest mature female observed was 515 mm, and all the females were mature in the 700 mm length group. The fifty-percent maturity points were 549.0 mm and 579.6 mm for males and females, respectively.

The fecundity of rohu is reported to vary from 226,000 to 2,794,000, depending upon the length and weight of the fish and weight of the ovary, as shown in Table 1.19.

The spawning season of rohu generally coincides with the southwest monsoon, though it appears to be somewhat variable in different parts of India as seen in Table 1.20.

Table 1.19. Fecundity of rohu.^a

Length of fish (cm)	Weight of fish (kg)	Weight of ovary (g)	No. eggs per g ovary weight	Total no. eggs	No. eggs per g body weight	Percentage of ovary weight in body weight
51	1.75	300	1,230	369,000	211	17
54.5	1.50	300	965	289,500	193	20
57.3	2.00	250	906	226,500	113	12.5
57.5	2.50	500	1,516	758,000	303	20
61	2.25	262	1,025	268,500	109	11.6
62.0	2.7	500	1,528	764,250	283	18.5
69.0	2.5	450	747	335,925	134	18
73.0	6.75	2,000	1,387	2,794,000	413	29.6

^aFrom Khan and Jhingran (1975).

Table 1.20. Spawning season of rohu in different parts of the Indian subcontinent.^a

Spawning season	Locality
July-August	Western Uttar Pradesh and Punjab
June-August	Orissa and West Bengal
April-June	River Halda, Chittagong
April-August	Ganga system of north Bihar
July-August	Ganga system (Aligarh, Uttar Pradesh)
April/May-June	Assam
June-September	Aligarh

^aFrom Khan and Jhingran (1975).

A fully swollen, water-hardened egg of rohu has a volume of approximately 0.078 ml. A rohu hatchling after absorption of its yolks etc weighs approximately 0.0021 g.

Mrigal

Mrigal (Fig. 1.7) is the natural inhabitant of the freshwater sections of the rivers of northern India, Bangladesh, Burma and Pakistan. It has been transplanted into waters of peninsular India for aquaculture.

A large number of intergeneric hybrids has been produced at the Pond Culture Division of the Central Inland Fisheries Research Institute, India. These are:

Male parent species	Female parent species	Hybrids
<i>Catla catla</i>	<i>Cirrhinus mrigala</i>	<i>Catla-mrigal</i>
<i>Labeo rohita</i>	<i>C. mrigala</i>	Rohu-mrigal
<i>C. mrigala</i>	<i>L. rohita</i>	Mrigal-rohu
<i>C. mrigala</i>	<i>Labeo calbasu</i>	Mrigal- <i>Labeo calbasu</i>

The first generation hybrids of male mrigal and female rohu were produced in 1958. Hamsa (1971) reported that the fertile hybrid between male rohu and female

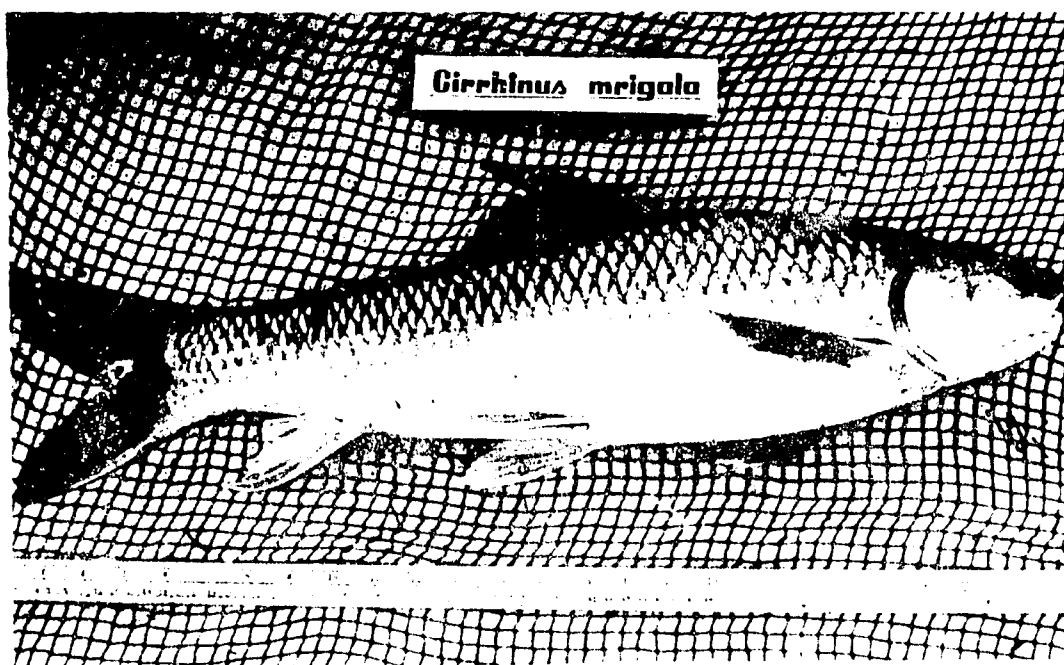
Fig. 1.7. Mrigal, *Cirrhinus mrigala*.

mrigal has a deeper body than either of its parents, while the head is bigger than mrigal but smaller than rohu. Most of the body characteristics of offspring produced by crossing the reciprocal hybrids, rohu-mrigal and mrigal-rohu, were intermediate between those of the parents. Both types of hybrids matured fully in two years. Hybrid mrigal-*Labeo calbasu* has a slightly fringed lower lip and two pairs of prominent black barbels. The color of the body was intermediate between the species. Some male hybrids produced were observed to have matured in one year (Chaudhuri 1973). In August 1960, two-year old, fully mature specimens of mrigal-rohu and rohu-mrigal hybrids were examined. Males were mostly in the oozing condition (Chaudhuri 1973). The first generation of fully mature mrigal-*Labeo calbasu* female hybrids was successfully spawned by hormone injection and crossed with males of catla, *Labeo calbasu* and mrigal. The following hybrids were produced:

Male parent species	Female hybrids	Hybrids
<i>Catla catla</i>	mrigal- <i>L. calbasu</i>	catla-mrigal- <i>L. calbasu</i>
<i>Labeo calbasu</i>	mrigal- <i>L. calbasu</i>	<i>L. calbasu</i> -mrigal- <i>L. calbasu</i>
<i>Cirrhinus mrigala</i>	mrigal- <i>L. calbasu</i>	mrigal-mrigal- <i>L. calbasu</i>

A few males of these hybrids were reported to have attained maturity in one year (Chaudhuri 1973).

Chaudhuri (quoted by Hickling 1968) crossed male *Ctenopharyngodon idella* with female *Cirrhinus mrigala* in 1963 and 1965 and found that 95% of the eggs hatched but the hatchlings showed abnormal growth and died within a few days.

Mrigal is a detritus eater with a narrow range in food variety. It is a bottom feeder subsisting mainly on decayed vegetation. Some workers consider mrigal an omnivore also frequenting the water column for feeding.

Semi-decayed organic matter constitutes about 65 to 78% of the gut contents of the different size groups of mrigal, with semi-digested organic matter followed by plankton predominating in the size groups 561 mm to above 766 mm fish length and the reverse in the younger age groups measuring up to 560 mm length. Considerable amounts of sand and mud, the former measuring up to about 21% of the gut contents and the latter up to about 13% are encountered.

In natural waters, mrigal is known to attain lengths as shown in Table 1.21 from two of the most important rivers of its area of occurrence in India, Rivers Ganga and Yamuna.

In natural waters, the fish shows a very rapid growth rate in the first four years of its life, followed by a period of slow growth in the next three years. The growth rate thereafter becomes even slower.

Under conditions of aquaculture, the growth rate is a function of stocking rate, natural food available and feeds given, competition with other co-stocked fish and environmental conditions. A large number of workers mention highly varied growth rates for mrigal in culture waters. The available information in the literature is summarized in Table 1.22.

Table 1.21. Size attained by mrigal at various years of its life in the Rivers Ganga and Yamuna.^a

Age (years)	River Ganga		River Yamuna
	Total length (mm) derived from scales	Weight (g)	Total length (mm) derived from scales
1	290.9	245.7	268.0
2	511.4	1,512.0	458.4
3	670.5	3,618.0	644.2
4	797.4	6,324.0	736.1
5	858.0	8,030.0	816.7
6	888.5	8,960.0	867.1
7	911.0	9,712.0	924.0
8	921.8	10,090.0	958.6
9	947.0	11,000.0	—
10	958.25	11,930.0	—
11	958.25	11,930.0	—
12	992.0	12,770.0	—

^aAdapted from Jhingran and Khan (1979).

Table 1.22. Growth of mrigal under different culture conditions.^a

Length and/or weight attained by mrigal	Time span	Length and/or weight attained by mrigal	Time span
200-250 mm and 350 mm	First year	580 mm	First year
350 mm	Second year	720 mm	Second year
		780 mm	Third year
180 mm	3-1/2 months		
		830 mm	Four years
450-600 mm/1,135 to 1,815 g	One year		
		275 mm	First year
550-650 mm/1,362 to 1,170 g	One year	480 mm	Second year
		630 mm	Third year
650-1,800 g	First year	740 mm	Fourth year
2,600 g	Second year	840 mm	Fifth year
4,000 g	Third year	873 mm	Sixth year
		900 mm	Seventh year
500 mm	First year	913 mm	Eighth year
640 mm	Second year	920 mm	Ninth year

^aAdapted from Jhingran and Khan (1979).

Mrigal is reported to attain its first maturity when about one year old (Jhinga and Pillay 1962) or two years old (Khan 1934; Alikunhi 1957). According to Chacko and Ganapati (1951), the males mature at the end of the first year and females, some time later. Hanumantharao (1971) reported the first maturity of mrigal at a length of 349 mm, when the fish was 2+ years old. Induced-bred one year-old mrigal of both sexes were found to be sexually mature in two ponds at Killa Fish Farm of Central Inland Fisheries Research Institute located at Cuttack. The minimum age of mrigal at first maturity, in waters around Aligarh (India), has been reported to be two years for males and three years for females (Khan 1972).

Khan (1934) observed the fecundity of mrigal to vary from 124,800 to 1,905,000 in specimens weighing 904 g and 4,503 g, respectively. Chaudhuri (1963) recorded that maximum number of eggs released by a mrigal, weighing 4.76 kg, was 1,164,000. Chakrabarty and Singh (1963) recorded the fecundity in mrigal to range from 463,671 to 1,809,536. Table 1.23 shows fecundity of mrigal collected from the River Yamuna at Allahabad, India.

Hanumantharao (1971) estimated the fecundity of 40 mature mrigal from the River Godavari, India and reported it to range from 75,900 to 1,123,200 in specimens measuring 349 mm to 810 mm in length. The relationship between fecundity (F) and total length (L) in mrigal was derived by him as:

$$\text{Log } F = 1.2225 + 2.4683 \text{ Log } L$$

Table 1.24 shows the fecundity of mrigal estimated for different age groups. The fecundity was found to be maximum in fish 5-7 years of age.

Table 1.23. Fecundity of mrigal collected from River Yamuna at Allahabad.^a

Weight of fish (g)	Weight of ovary (g)	Average number of eggs per gram of ovary	Fecundity
5,897	745	1,481	1,103,025
5,897	125	1,453	181,685
6,971	373	1,873	685,201
7,031	349	1,309	456,682
7,144	1,506	1,194	1,798,164
7,711	818	800	654,515
13,013	2,144	844	1,809,536

^aFrom Jhingran and Khan (1979).

Table 1.24. Average fecundity of mrigal from the River Godavari, India for different year classes.^a

Age (years)	2	3	4	5	6	7
Fecundity in thousands	160	289	564	596	744	814

^aFrom Jhingran and Khan (1979).

According to Qasim and Quyyum (1962), mrigal contains a single group of maturing eggs in the ovaries and spawns once a year. Khan (1972) confirming these findings stated that the size of oocytes started to increase in April. The maximum size of ova was recorded during June. Spent fish contained either few or no mature ova in the ovary during post-spawning months. The size of mature ova varied from 0.92 mm to 1.10 mm. At the Pond Culture Substation of the Central Inland Fisheries Research Institute, mrigal, like other major carps, has been induced to breed twice within the same spawning season after an interval of two months.

The spawning season of mrigal depends on the onset and duration of the monsoon. It coincides with the southwest monsoon in India, Bangladesh and Pakistan. The duration of the spawning season varies in different regions of the subcontinent, as shown in Table 1.25.

A fully swollen and water hardened laid egg of mrigal has a volume of approximately 0.11 ml. A mrigal hatchling after its yolk sac is absorbed weighs about 0.0025 g.

Table 1.25. Spawning season of mrigal in the Indian subcontinent.^a

Locality	Spawning season
Punjab	July and August
West Bengal	June and July
Chittagong	April-June
Chittagong Rivers Halda and Karnafuli	April-July
South India (The Godavari and Krishna)	July-September
—	June-August
Ganga River system (depending upon floods in each region); Western Uttar Pradesh	April-August
Northern India (River Ganga)	June-August
Madhya Pradesh	During southwest monsoon from the end of June
Western Uttar Pradesh (Rivers: the Ganga, Yamuna and Kali)	July-August
Allahabad (River Yamuna)	June-August
Different parts of the country	Mid-May to end of August
Tilaiya and Panchet reservoirs	July
North Bihar (Kosi Khanua Dhar) a tributary of River Kosi	June

^a Adapted from Jhingran and Khan (1979).

Components of a Carp Hatchery

The Site

Sites which enable easy fulfilment of the following objectives, naturally or in-expensively, qualify for locating a carp hatchery:

1. ponds excavated at the site should provide a water retentive soil base, exposed by digging or transfer of top soil of the site to pond bottom and embankments;
2. the soil should possess basic mineral nutrients and respond readily to organic and inorganic fertilization;
3. there should be a dependable source of perennially available water in adequate quantity for the size of the proposed hatchery;
4. self-draining ponds should be used on sloping sites;
5. the physical and chemical properties of the water are within acceptable limits, such that water quality can be further manipulated by chemical treatment to suit aquacultural needs;
6. the site is easily accessible by rail and/or road and air;
7. there is a market in the vicinity;
8. fertilizers and raw material for feeds required for aquaculture operations and building material for constructing the hatchery are available near the site;
9. there is no industrial, domestic or pesticide pollution at the site;
10. there are reasonable educational and medical facilities available in the vicinity of the site;
11. there may be scope for integration of aquaculture with agriculture, horticulture or floriculture at the site.

SOIL QUALITY

The biological productivity of a natural pond mainly depends on the quality of its soil base. A satisfactory pond bottom soil is one which, apart from being impervious to water, permits rapid mineralization of organic matter, absorbs nutrients loosely bound and releases them slowly over a long period.

Silty clays, clay-loams, loams, etc., generally make good quality soils for a fish pond. Rocky outcrops, shale ledges, sand, gravel and limestone areas must be avoided. If, however, a measure of soil porosity becomes unavoidable, then pond bottom may be treated with bentonite, clay or other soil sealants. Sprayed-on asphalt liners and plastic film liners can also be used to reduce or prevent seepage but any such treatment apart from being expensive, in effect, seals off the soil-water interface with an inert substance and prevents soil-water exchange of minerals and nutrients, which is detrimental to biological productivity. Fertilization, especially organic manuring over a period of time, automatically reduces the rate of seepage by sealing soil pores. It also reduces water turbidity caused by suspended silt and colloids. Algae, in the presence of electrolytes, aid in the latter process by flocculation. If a liner is to be installed to prevent seepage, it is desirable to put it about 200 cm

below the pond bottom so that there exists a thick substratum of water-soaked soil at the bottom of the pond.

The minerals and nutrients required for securing biological productivity for the pond have basically to be drawn into the pond water from the pond soil. The pond has to be enriched artificially for sustenance of its productivity once its inherent fertility is used up. Economic considerations in aquaculture demand that the barest minimum of fertilization be done artificially. This brings to the fore the extreme importance of pond soil chemistry and its intimate direct relationship with pond fertilization. Well-polarized, often diametrically opposite schools of thought in N-P-K fertilization exist in the literature in aquaculture. While considerable scientific knowledge has been amassed on agricultural soils in relation to fertilization and cereal or horticultural production, little is known on water-submerged soils of ponds in relation to pond fertilization. This is one area in which further research in aquaculture will pay rich dividends in economizing aquaculture (see further discussion on pond fertilization, p. 64-67).

WATER QUALITY

Water of desirable quality and quantity is perhaps the most important requirement of a carp hatchery. The usual sources of water for a carp hatchery are rain water, reservoirs, rivers and streams, springs, irrigation canals, surface run-off, open wells, tubewells and artesian wells.

Flow-wise, by virtue of their elevated locations, perhaps the best and most reliable sources of water supply are reservoirs. Water from rivers, canals and surface run-off sources, apart from being prone to flooding (floods are often destructive), more often than not carry a heavy load of silt which is very undesirable, especially in the hatchery proper. In the hatchery proper, silt smothers eggs, hampering their development; in ponds, it leads to siltation reducing pond volume, obstructs penetration of sunlight and adversely affects pond productivity.

Water from underground sources is generally free from biota and in that respect is the safest, but often suffers from the serious drawback of deficiency in dissolved oxygen. Water with a high dissolved oxygen content (6-9 ppm) at required temperature is the most essential requirement of a hatchery proper. Dissolved oxygen level in the water is made good by installing aeration devices before its entry into the hatchery proper.

Planning for Hatchery Construction

Before hatchery construction commences, it is essential that the site be examined carefully as to the characteristics on various points in Table 2.1 and those stated above. It is necessary to dig 2.5-m deep pits at fairly close range along a grid and examine soil samples drawn from 25-cm depth level profiles on their physical and chemical properties. Laboratory seepage tests with soil samples may be carried out to assess water retention. It is also necessary to look for depth of the subsoil water table during the hottest part of the year and carry out laboratory examination of the physical and chemical properties of the water available at the site. It is absolutely essential that water sources at the site be carefully examined as to the quantities of water available in different months of the year commensurate with the needs of the size of the hatchery desired. A detailed contour survey of the site is an essential prerequisite for preparing a master plan of the layout of the hatchery.

Table 2.1 shows the characteristics of a satisfactory carp hatchery site.

Table 2.1. Characteristics of a satisfactory carp hatchery site.

Characteristics	Quality
Nature of terrain	Non-rocky having at least 2.5 m deep soil cover.
Slope of the terrain	Gently sloping such that terraced self-draining ponds can be carved out.
Physical quality of soil	Soil fraction should be 90% of the whole soil—stone and gravel not exceeding 10%.
Chemical quality of soil	pH near neutral; total available N > 0.1%; total available P > 0.1%; total available C > 1.0%; should be responsive to organic and inorganic fertilization.
Rate of seepage	< 1 meter/annum.
Subsoil water table	Should not be far below deepest pond bottom in driest summer month in case soil is not completely water retentive.
Water supply	There should be a dependable source of perennial water supply sufficient to meet the total water requirements of the hatchery.
Chemical quality of water	pH near neutral; temperature range 20°C to 30°C; should be responsive to organic and inorganic fertilization.

Essential Components of a Hatchery

The various essential components of a hatchery are:

- broodfish ponds to hold adult fish for spawning and serve as donors of pituitary glands and to accommodate spent females and males;
- a hatchery proper comprising a complex of facilities for fish spawning, hatching and care of hatchlings to raise them up to postlarval stage;
- nursery ponds for rearing postlarvae to fry stage;
- rearing ponds for growing fry to fingerlings;
- ponds for production of fish to supply broodfish ponds and donors of pituitary glands.

In this chapter, consideration is first given to the land areas to be converted into different pond types and hatchery facilities. For this, one has to start with certain basic decisions, including the carp species, their sizes and the quantities desired to be produced. It is presumed here as an example that the species to be produced are among the seven species of carps mentioned in Chapter 1 and that the objective is to produce annually 100 t of table-sized fish of these species.

The assumptions shown in Table 2.2 are made to derive the requisite numbers of various life-history stages of different species to produce 100 t of fish per year.

Table 2.2. Assumptions to derive pond areas and numbers for a production of 100 t of fish/year.

Number	Assumption
1	It is a system of polyculture of the seven species, viz. catla, rohu, mrigal, silver carp, bighead carp, grass carp and common carp.
2	The density of production of table-sized fish is 5 t/ha.
3	The rate of stocking of postlarvae is 1.5 million/ha or 150/m ² .
4	The rate of survival of postlarvae to the fry stage is 50%.
5	The rate of stocking of fry to raise them to fingerlings is 125,000/ha.
6	The rate of survival in rearing fry to the fingerling stage is 80%.
7	The rate of survival in rearing fingerlings to table-sized fish is 90%.
8	A fish is considered marketable when it is 750 g in weight.
9	An average female broodfish produces 50,000 viable postlarvae.
10	Proportion of female broodfish which will respond to hypophysation is 50%; males 100%.
11	Average weight of female spawner preferred for hypophysation is 4.5 kg.
12	On the average, a female broodfish for induced breeding needs 10 mg/kg of pituitary hormone/kg and a male broodfish requires 4 mg/kg of pituitary hormone.
13	On an average a donor fish would yield 3 mg/kg of pituitary gland.

The following ratios of the carp species are further presumed.

Surface Feeders		Percentage
Phytoplankton	silver carp	20
Zooplankton	bighead carp	10
Zooplankton	catla	10
Bottom Feeders		
Omnivore	common carp	20
Detritus	mrigal	10
Column Feeder		
Browser	rohu	15
Macrovegetation Feeder		
Aquatic foliage	grass carp	15

It is taken for granted that the stock ponds under consideration are still-water ponds provided with facilities for draining and, therefore, inlets and monk outlets. For production of 100 t of table-sized fish per year, the water surface of stock ponds required is 20 ha.

The number of fingerlings (y) required per hectare can be calculated from the following formula.

$$a \times y \times b = c$$

where a = survival rate; b = size at harvesting; c = yield at harvesting.

Substituting the assumed values for a, b and c, one can solve for y as follows:

$$0.9 \times y \times 0.75 \text{ kg} = 5,000/\text{ha}$$

$$y = 7,407 \text{ fingerlings/ha}$$

The required number of fingerlings of each species can be calculated as shown in Table 2.3.

Table 2.3. Number of fingerlings of different species to produce annual harvest of 100 t.

Species	Species composition (%)	Requirement of fingerlings (no./ha)	Total requirement of fingerlings (no./year) ^a
Silver carp	20	1,481	29,620
Bighead carp	10	741	14,820
Catla	10	741	14,820
Common carp	20	1,481	29,620
Mrigal	10	741	14,820
Rohu	15	1,111	22,220
Grass carp	15	1,111	22,220
Total	100	7,407	148,140

^aFingerlings/ha x 20 ha, being the requirement of water surface area to produce 100 t/year.

Based on a survival rate of 50% in nursing postlarvae to fry, the number of postlarvae required can be calculated as:

$$\frac{185,175}{0.50} = 370,350$$

Based on a survival rate of 80% in rearing from fry to fingerling stages, the total number of fry required can be calculated as:

$$\frac{148,140}{0.80} = 185,175$$

As per Assumption 5, to stock 185,175 fry, the rearing space required is $185,175/125,000 = 1.48$ ha, say 1.5 ha. If the rearing pond is 0.2 ha, which is a convenient size for netting purposes, eight rearing ponds will need to be prepared in the hatchery. As per Assumption 3, the stocking rate of postlarvae is 1.5 million/ha. Therefore, to stock 370,350 postlarvae, the nursery space required is $370,350/1,500,000 = 0.25$ ha. If each nursery pond is 0.05 ha, which is a convenient size for netting operations, five nursery ponds will need to be prepared.

Requirements of Broodfish and Broodfish Ponds

All the carps under consideration here have high fecundities which vary a great deal according to species (Chapter 1). Further, fecundity is a function of the age of the broodfish, its nutrition and, therefore, the feeds it has been given. However, for the sake of breeding purposes, and until enough scientific knowledge of the control of fecundity in different species of carps is gathered, female broodfish weighing 3-6 kg each can be presumed to produce 50,000 postlarvae each (Assumption 9). Furthermore, a set of spawners of a given species is taken to comprise three specimens, one female and two males, such that the total weight of female broodfish approximately equals the total weight of male broodfish.

In the present illustration, the number of postlarvae required is 370,350. This number of postlarvae can be produced by induced breeding eight female spawners of different species together weighing 36.0 kg ($4.5 \times 8 = 36.0$ kg) and 16 males also together weighing 36.0 kg. But since there are seven different species, two female broodfish of each species would be required, which, at an average weight of 4.5 kg, would altogether weigh 9.0 kg/species. For seven species, the total weight of females would be 63.0 kg. But, vide Assumption 10, success in production of postlarvae may be only 50%. Therefore, the total weight of female broodfish required in this model is 126.0 kg. The approximate number of male broodfish required remains 28, together weighing 63.0 kg. The total weight of female and male broodfish would thus be 189.0 kg.

Based on Assumption 12 of hormone requirements, 126 kg of female broodfish would need 1,260 mg ($126 \times 10 = 1,260$ mg) of pituitary gland and 63 kg of male broodfish would need 252 mg. Total weight of pituitary glands required would be 1,512 mg.

Based on Assumption 13 of 3 mg/kg of pituitary gland from donor fish, 1,512 mg of pituitary gland material can be got from 504 kg of donor fish taking into account 10% wastage.

Requirements in weight of adult fish for breeding as well as for donor fish, therefore, are 743 kg (189.0 kg for breeding and 554 kg for donor fish).

The rate of stocking of broodfish ponds is 1,000 kg/ha. Therefore, for stocking 743 kg of adult fish 0.743 ha or say 0.8 ha are required. It is improper to have a

broodfish pond of less than 0.2 ha area for convenience of netting, feeding, aeration, application of prophylactic and therapeutic chemicals as well as flushing the pond with fresh cool water for proper gonadal development. Therefore, in this illustration, four broodfish ponds of 0.2 ha each are to be prepared, which will all together give a stocking capacity of 600 kg of adult fish against the requirement of 449 kg. It must, however, be borne in mind that when the targets of production are high, many broodfish ponds, which should be different from stock ponds, would be required. For further information on current practices in broodstock husbandry (stocking density and nutrition) see Table 8.19 (Chapter 8).

Twenty-eight female spawners, allowing for 50% success in ovulation by hypophysation, complemented by 28 male spawners, would besides supplying 1,512 mg of pituitary glands for hypophysation, on induced breeding, furnish 370,350 post-larvae. These would need 0.25 ha of nursery space and would, at the survival rate of 50%, yield 185,175 fry. These fry, at the survival rate of 30% would produce 148,140 fingerlings requiring 1.6 ha of rearing ponds. The total of 743.0 kg of broodfish of all the seven species required to produce 370,350 postlarvae, would require 0.80 ha of broodfish ponds.

The space requirements may be as shown in Table 2.4.

Type of ponds	Area of ponds (ha)	Number of ponds	Total area of ponds (ha)
Broodfish	0.20	4	0.80
Nursery	0.05	5	0.25
Rearing	0.20	8	1.60
Stock	1.00	20	20.00
			22.65

STRUCTURAL FEATURES OF DIFFERENT TYPES OF PONDS

The salient features of different types of ponds are:

Nursery Ponds: Drainable, small ponds, 0.01 to 0.1 ha and depth around 0.5 to 1.2 m. Pond bottom gently sloping towards outlet but plane. Rectangular shape and convenient width for netting operations. A sump at outlet for collection of fry.

Rearing Ponds: Drainable ponds larger than nurseries and of depth of around 0.8 to 2 m. Pond bottom plane but gently sloping towards outlet. Rectangular shape and convenient width for netting operations. A sump at outlet for collection of fry and fingerlings.

Drainability of both nursery and rearing ponds is highly desirable because during the slack season, it would enable the pond bottom to be exposed to sun, aeration, mineralization and aerobic destruction of the organic load which otherwise might lead to hydrogen sulphide production, which is toxic. Other advantages of drainability are ease of control of parasites, predators and unwanted fish; ease of application of toxicants, manures and fertilizers if ploughing is necessary, facilitating cultivation of nitrogen fixing crops like leguminous plants; ease of harvesting, a process greatly facilitated by constructing a sump at the approach to the outlet.

Stock and/or Broodfish Ponds: Drainable, of rectangular shape. Should have provision for flushing with "cold" water of 25-28°C. A convenient source of such water is a well (artesian, open or tube) or an underground spring. A width of 20-30 m facilitates netting operations. Depths are generally 1 to 2.5 meters but greater depth

is preferred in cold climatic zones and arid or semi-arid areas where the rate of evaporation is high.

In the case of nursery and rearing and even stocking ponds, it is advisable for each pond to have its water supply routed through a sand and pebble filter set up in a concrete structure with water moving upward from below (reverse flow filter) and entering the pond from the top of the filter (Fig. 2.1). The advantage of individual water filters for each nursery and rearing pond is that the filter would not only clean the water but very effectively control the entry of unwanted fish, their young and even the eggs, into the ponds. One of the more important causes of mortality of carp hatchlings and fry in nursery and rearing ponds is predation by unwanted fish, and the filter would provide the most effective way of removing the cause of the problem. The same applies to stock ponds where carp fingerlings can be preyed upon by unwanted fish. The unwanted fish not only prey upon carps but also share the natural and artificial food which is meant for the carps.

It may be mentioned here that with advancement of technology, the stocking and survival rates might increase, in which case, the model illustrated here would not apply. However, the principles illustrated would remain valid. A new set of stocking and survival rates would have to be presumed to work out pond area requirements for still-water, pond-based aquaculture.

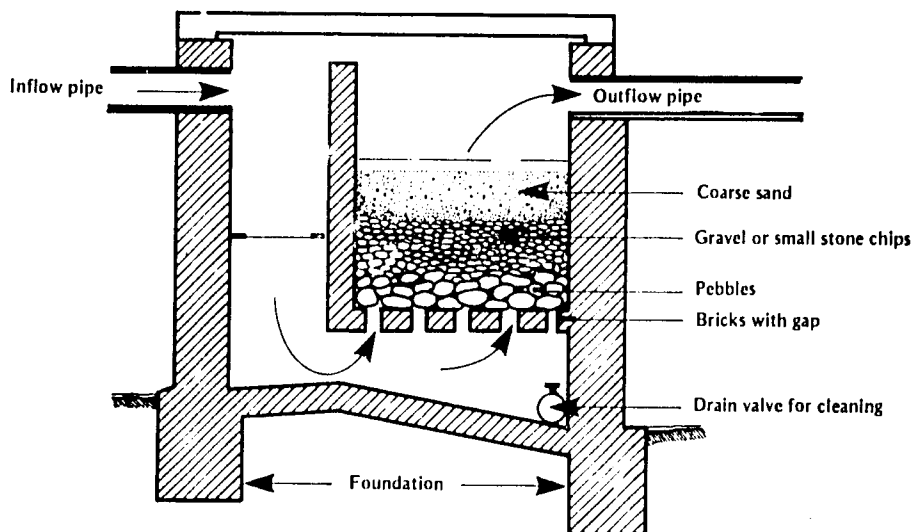

Fig. 2.1. A reverse flow filter (reproduced from Woynarovich 1975).

Placement of Different Types of Ponds in a Hatchery

The location of different kinds of ponds in a hatchery is of considerable importance for ease of operation and minimization of operating costs.

As mentioned earlier, a detailed contour survey of the area where the hatchery is to be built must precede fish farm construction. This will minimize filling or digging and movement of earth, which all cause expenditure on labor or mechanical earthmoving. The lowest area of the terrain must be developed into stock ponds, appropriate higher areas developed into rearing ponds and areas higher still into nursery ponds (see Fig. 2.2). The same principle would apply to developing swampy and marshy lands into fish farms, the deepest being converted into stock ponds. The highest of the areas, on this principle, are to be developed into the hatchery proper, closest to which must be located water treatment, filtration and sedimentation plants and the water tower, laboratory, hatchery office and residential houses for the staff. This arrangement will place the nurseries closest to the hatchery proper, which is a logical arrangement. The fish breeding tanks from inside the hatchery building may lead to outdoor nursery ponds by suitable conduits. As hatchlings

Fig. 2.2. A bird's eye view of the Fish Hatchery and Training Centre, Raipur, Noakhali, Bangladesh (reproduced from a photo by one of the authors).



grow into fry and fingerlings, they can be, with least expense, conveniently transferred from nursery to rearing to stock ponds. Broodfish in the ponds in the above-stated arrangement would be farthest from the hatchery, however, the ante-tanks in the hatchery provide holding space for broodfish close by the fish-breeding tanks.

The Hatchery Proper

The hatchery proper is perhaps the most vital component of a modern fish farm. Incorporation of a hatchery in a carp farm is a relatively recent development in the history of carp culture. It is a logical corollary of the development of induced breeding as a technique for commercial production of carp seed. In providing flowing water of high oxygen content, a carp hatchery follows the basic principles of a salmonid hatchery in which stripping has been a very old practice in different parts of the world. In the early days of induced carp breeding, there were only outdoor breeding and hatching facilities mainly comprising cloth enclosures (called *hapas*) installed in ponds. The use of *hapas* involves mechanical transfer of eggs from breeding *hapas* (Fig. 2.3) to hatching *hapas* (Fig. 2.4) and from hatching *hapas* to storage *hapas* for temporary storage while they grow to an early fry stage before transfer to carp nurseries for raising to the late fry stage.

The essential components of a modern hatchery proper are ante-tanks or storage tanks; breeding tanks or ward tanks; incubators or hatching jars; larval rearing tanks.

Fig. 2.3. A breeding *hapa*.

Fig. 2.4. A hatching *hapa*.

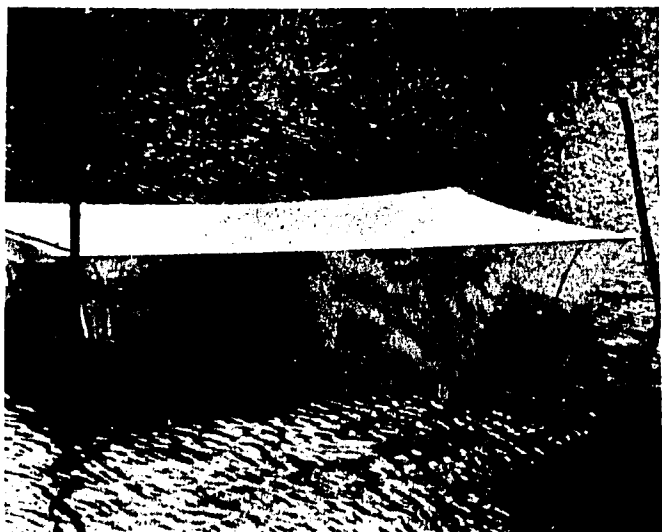

Fig. 2.3

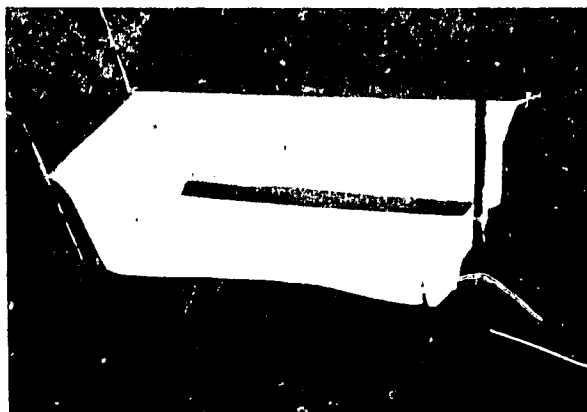

Fig. 2.4

The infrastructural facilities and functional alternatives of these components, as they have evolved with the passage of time, are described below:

Ante-tanks: The purpose of ante-tanks is to hold selected ripe breeders prior to hypophysation. The ante-tanks must be at least two in number, one for each sex of a species of fish in the smallest hatchery. A 200 m² or 450 m² (10 m x 20 m or 15 m x 30 m) ante-tank of 1.0 to 1.5 m depth can hold 25-50 sets of broodfish (each set comprising one female and two males) with female spawners weighing 3-6 kg each, and sexes segregated in the two tanks.

In many modern hatcheries, ante-tanks may serve diverse functions at different times. These functions are:

1. holding breeders before hypophysation;
2. holding and rearing fry prior to sale;
3. holding fingerlings prior to sale;
4. serving as treatment tanks for diseased or infected fry, fingerlings and broodfish;
5. providing additional space for operating jar or funnel incubators.

In case the ante-tanks are to serve as multipurpose tanks in a hatchery, their dimensions may be altered to a more elongated shape, retaining their twin character, and their numbers increased as per need.

Breeding Tanks: Also called ward tanks, the purpose of breeding tanks is to hold injected breeders for natural spawning and fertilization. These tanks, regardless of their shape and size, essentially need a continuous supply of filtered, clear, clean and well-oxygenated running water of optimum temperature. With the passage of time in carp aquaculture, the breeding tanks have undergone great changes in their shape and design and, to an extent, "automation" has been incorporated to effect self-transfer of fertilized eggs into hatching tanks. A common feature of breeding tanks, regardless of their shape and size, is that they should have a sloping bottom leading to the outlet so that they can be completely drained when required without leaving any eggs behind. Another common feature of breeding tanks is that it should be possible to maintain their water level. This is universally done by installing an outside standpipe (also at times called turn-down pipe) in each hatching tank (Fig. 2.5). Chain and peg are often used to lock the turn-down pipe in position to prevent it from slipping down and draining the breeding tank.

A breeding tank may be rectangular in shape, a convenient size being 2.5 m x 1.5 m x 1.0 m for holding 4-6 breeders and 4 m x 2 m x 1 m for 8-10 breeders weighing 3-6 kg each (both female and male) in each case. For still larger breeders weighing 12-20 kg each, even bigger breeding tanks, 7.5 m x 2.5 m x 1.0 m may be made. In breeding tanks of rectangular shape, if stripping is to be done, it is convenient to construct a 20-25 cm deep and 50 cm wide side-tank along the long axis of the breeding tank. The fish to be stripped may be conveniently pushed into the ditch without much disturbance to the remaining fish in the breeding tank. Stripping operations inevitably have to be done outside the tank in the hatchery building. It is advisable to fix a breeding *hapa* inside a breeding tank, the rectangular shape of which is more conducive to installation of a *hapa*. An advantage of a *hapa* in the above context is that it is much easier to handle, procure or release a spawner from and into a *hapa* and also to isolate and pick up individual spawners should it become necessary. The latter becomes quite difficult in a community breeding tank whatever its shape, despite operating a dip net.

CIRCULAR BREEDING, HATCHERY AND LARVAE REARING TANKS

In modern times more and more carp farms are incorporating circular breeding tanks in their hatcheries either as substitutes for existing rectangular breeding tanks

or as additional facilities. Breeding tanks of circular shape are of Chinese origin (Fig. 2.6). The advantages of a circular breeding tank are:

1. it is conducive to a continuous flow system;
2. within a limited space, it provides the effect of some aspects of the riverine environment which is the natural habitat of carps;
3. the centrifugal flow makes the operation of inlet and outlets more effective;
4. there are no dead areas as far as water flow is concerned, such as one encounters in rectangular or polygonal shapes; this makes distribution of oxygenated water in the tank more uniform and, hence, hatching more effective;
5. it is more conducive to protecting eggs from being washed out of the hatching facility by installation of a screen surrounding the centrally located outlet;
6. it makes additional aeration easier outside the centrally located outlet;
7. it can combine the functions of a breeding tank, a hatching tank as well as larvae-rearing tank;
8. it can lend itself to a modular type of design (Fig. 2.6) in which each breeding tank can be linked to twin circular hatching tanks such that the entire contents of the former can be accommodated at a time in a pair of hatching tanks with water containing fish eggs flowing by gravity. This procedure enables performance of a series of breeding operations almost continuously in the fish breeding season, given adequate numbers of breeding and hatching units of modular design.

Fig. 2.5. Twin tanks and ward tanks in a hatchery; also seen are outside-stand pipes or turn-down pipes (reproduced from Woynarovich and Horvath 1980). Fig. 2.6. Circular fish breeding, hatching and larvae rearing tanks in a modular design.

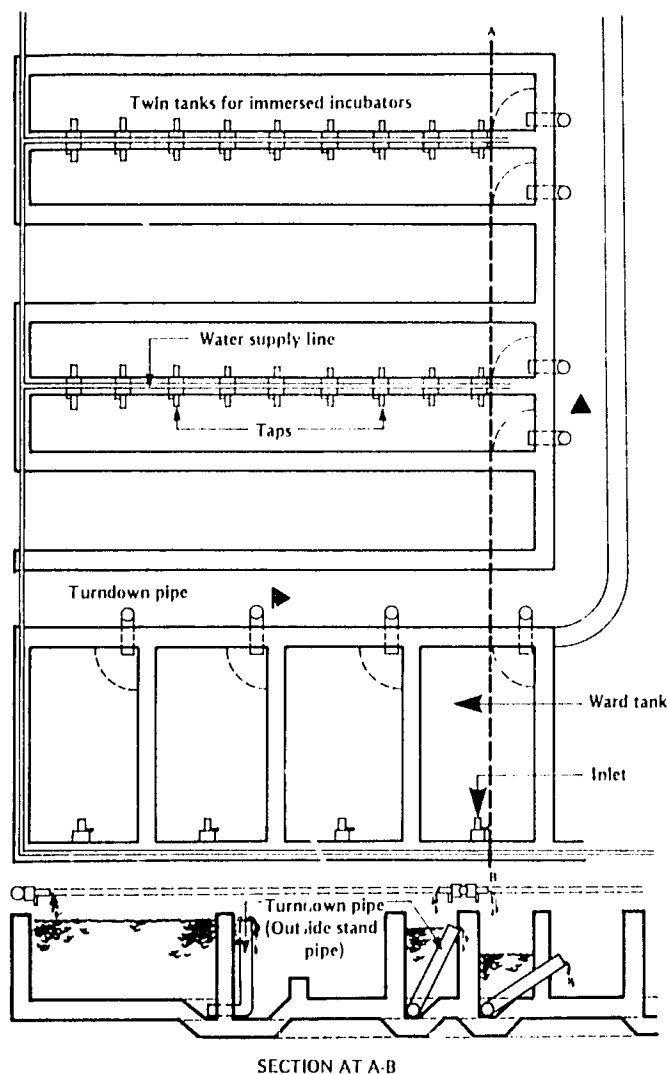

Fig. 2.5

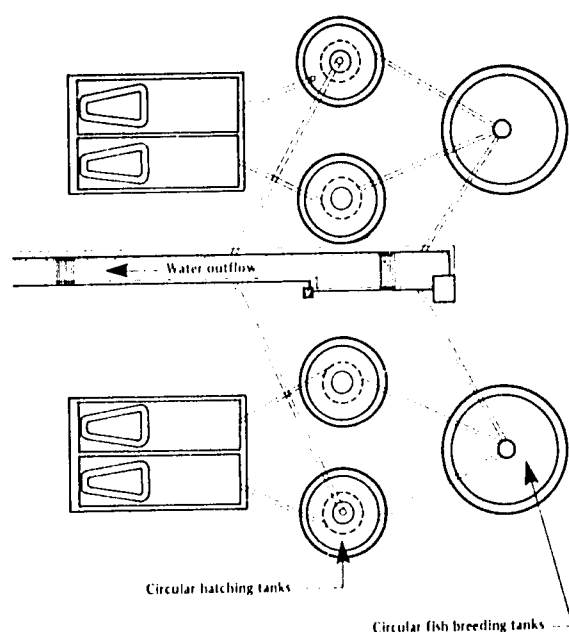

Fig. 2.6

The drawbacks of a circular breeding tank are that for functional effectiveness in order to breed 4-6 sets of broodfish weighing 3-6 kg each, a circular tank, by virtue of its shape, has to be larger in volume than a rectangular tank. Hence, it needs more water and in many hatcheries, water is a serious limiting factor. Monitoring of the extent of fertilization and hatching in fish breeding operations becomes difficult, especially in large circular breeding tanks. Defects in leveling in the drainage system, especially links with hatching tanks, become difficult to repair and remedy without dismantling the centrally located outlet structure underground below the brick work of the hatching tank.

A convenient size of a breeding tank is 2 m diameter and 1 m deep which would hold about 1,300 liters of water. To impart a circular motion to water, sideways-directed inlets are installed (Fig. 2.6) towards the bottom end of the hatching tank wall. The rate of flow of water in a 1,800-liter circular tank may be 6-8 liters/sec. The other components of a circular breeding tank are a socket to cover the centrally located drain hole into which would fit a uniformly perforated straight pipe and a screen covering the perforations (Fig. 2.7). The non-metal screen is to prevent eggs from escaping through the outlet.

It is possible for a circular breeding tank to function also as an egg incubator, a hatching tank and a fry rearing tank. If this is to be done, then the eggs must be allowed to remain in the breeding tank after they are spawned and fertilized and additional aeration given to them. This can be conveniently done by installing an air diffuser at the base of the screen surrounding the straight perforated pipe. The air diffuser should be of circular shape to encircle the perforated metal and be connected to an air blower or compressor through rubber tubes. The water level regulation in the circular breeding tank is done by the vertical stand pipe tightly fitting the central socket and through the turn-down pipe, manipulable from outside the circular breeding tank.

Incubators or Hatching Jars: Unless the functions of a hatching tank are combined with that of a breeding tank, separate hatching facilities are required in a hatchery. A wide range of options is available to a pisciculturist in incubating and hatching facilities.

Carp eggs can be incubated in e.g., MacDonald jars, zoug jars (Fig. 2.8), Weiss jars or Zug-Weiss jars which are readily available from suppliers in Europe and North America.



Fig. 2.7

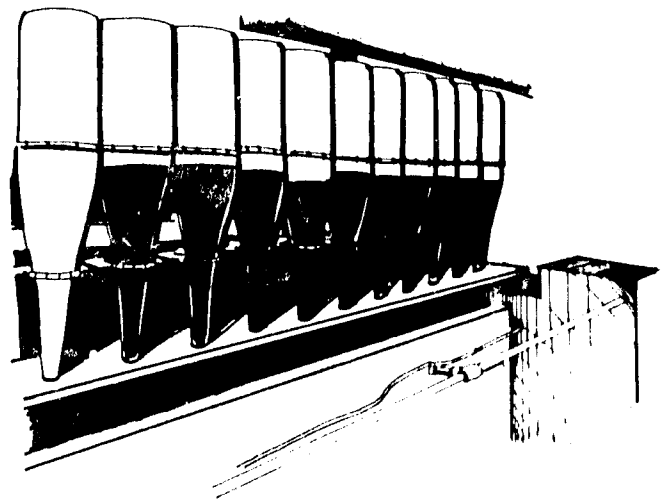

Fig. 2.8

Fig. 2.7. A circular concrete fish breeding tank; also seen are a sideways directed inlet and centrally located drain hole over which is fitted a straight perforated pipe covered by a screen (reproduced from a photo taken at the Fish Hatchery and Training Centre, Raipur, Noakhali, Bangladesh by one of the authors). Fig. 2.8 Carp eggs incubating in zoug jars at a fish hatchery in Dinnyeš, Hungary (reproduced from Huet 1972).

In a carp hatchery jar, the water inlet can be from below or above but the exit is always at the top. The design of the jar would depend upon which type of inlet is chosen. Ordinarily, however, hatchery jars with water supply from below are more commonly used. The hatchery jars with water supply from below can be of diverse volumes and shapes. The shape may vary from plain cylindrical contour to a funnel, conical or barrel shape. The material can be clear glass or clear plastic. Baked clay vessels can also be used which, though cheap and easily replaceable (also somewhat porous and hence cool due to surface evaporation) have the disadvantage of being opaque (Fig. 2.9). The volume of individual hatchery jars may vary from 1 liter to 200 liters. A one-liter jar has the capacity to hold 100,000 water-hardened swollen carp eggs.

In a hatchery jar with water supply from above, each hatchery jar needs a water inlet duct (Fig. 2.10) going down to the jar bottom which must have a round shape. On hitting the bottom of the jar, the water is reflected up into the jar creating a current in which eggs keep bobbing up and down as they develop.

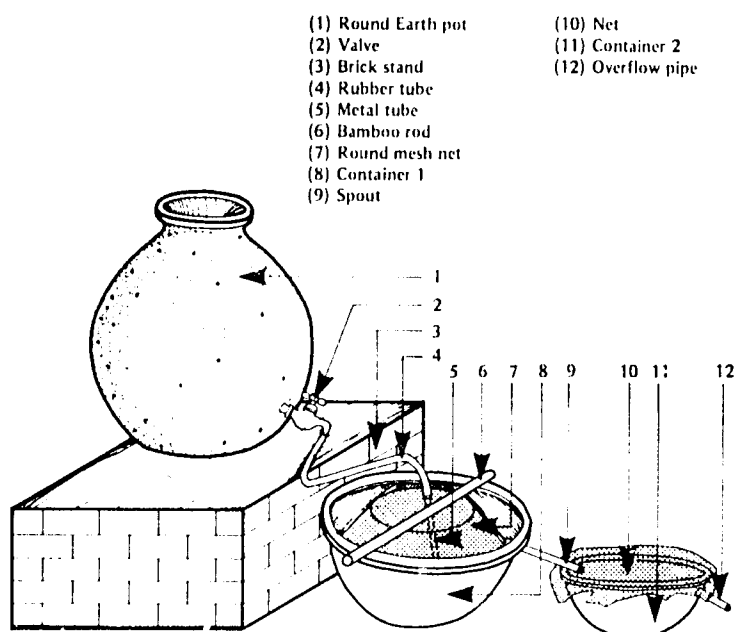

Fig. 2.9

Fig. 2.9. Baked clay vessels serving as a carp hatchery in a rural area in India (reproduced from Central Institute of Fisheries Education 1983). Fig. 2.10. Hatchery jar with water supply from above (reproduced from a photo taken at the Fish Hatchery and Training Centre, Raipur by one of the authors).

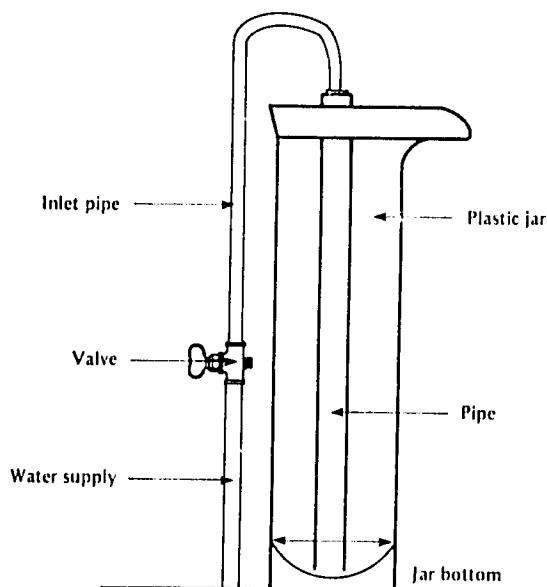

Fig. 2.10

The hatchery jars, of which normally dozens are required in a hatchery depending on its capacity, are usually fitted into holes made atop a rectangular table in rows of two such that a common central conduit can receive water discharged through the outlets of the jars of each row (Fig. 2.11). The conduits discharge into one or more hatchling holding tanks (Fig. 2.12) into *hapas* (a showering arrangement may be added over the *hapas* to enhance aeration). Fig. 2.13 presents an overall view of a glass jar hatchery containing hatchery jars with water supply from below.

FUNNEL-SHAPED HATCHERY DEVICES

In yet another hatchery arrangement, soft material like nylon or canvas is used to prepare funnel-shaped, immersed type of incubators (Fig. 2.14) which are installed in rectangular twin basins with water entering each incubator from the bottom. The water supply line, with taps fixed on both sides, is placed on top of the dividing wall (Fig. 2.15). The distance between taps may be about 60 cm. The supply line may be of 5 cm diameter for 20 taps and 7.5 cm wide for more than 20 taps. The twin basins may be 6-8 m long, 70 cm wide and about 1 m deep and have a turn-down pipe at one end to regulate the water level.

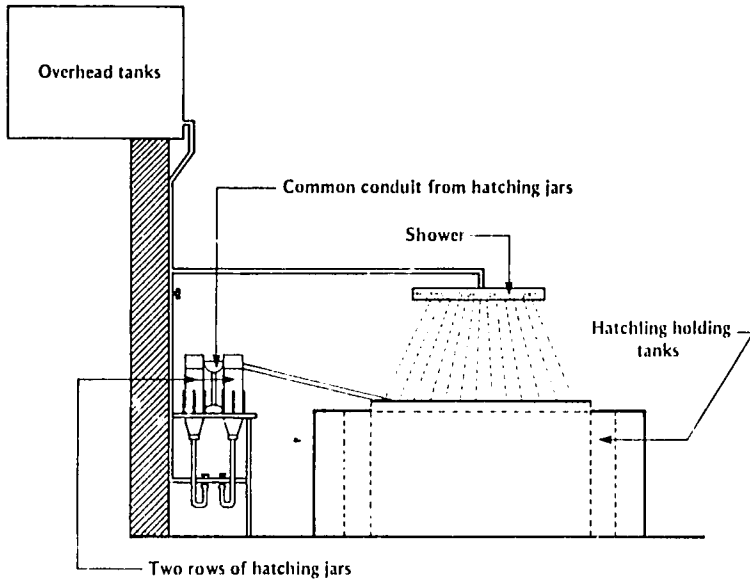

Fig. 2.11



Fig. 2.13

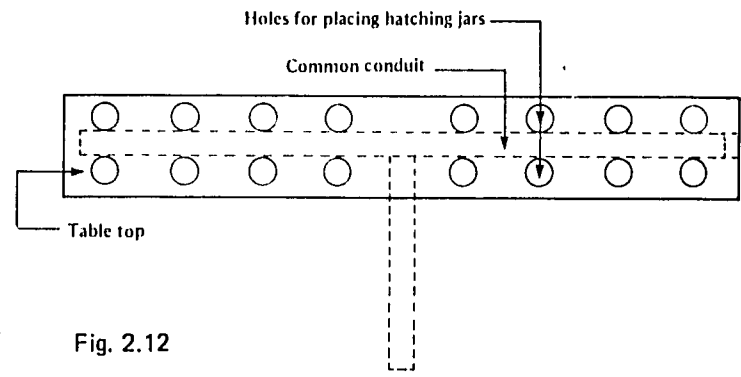

Fig. 2.12

Fig. 2.11. Placement of hatching jars in rows of two atop a rectangular table with a common conduit from jars from each row (reproduced from Bhowmick 1978). Fig. 2.12. Glass jar hatchery showing drainage from hatching jars through a common conduit into a hatchling holding tank with shower arrangement (reproduced from Bhowmick 1978). Fig. 2.13. An overall view of a glass jar hatchery at Cuttack India (reproduced from Bhowmick 1978). Fig. 2.14. Funnel-shaped hatching device (reproduced from Woynarovich and Hervath 1980). Fig. 2.15. Schematic diagram of a low density polyethylene made six-incubator hatchery unit (reproduced with the permission of Sinter Plast Containers, Bombay).

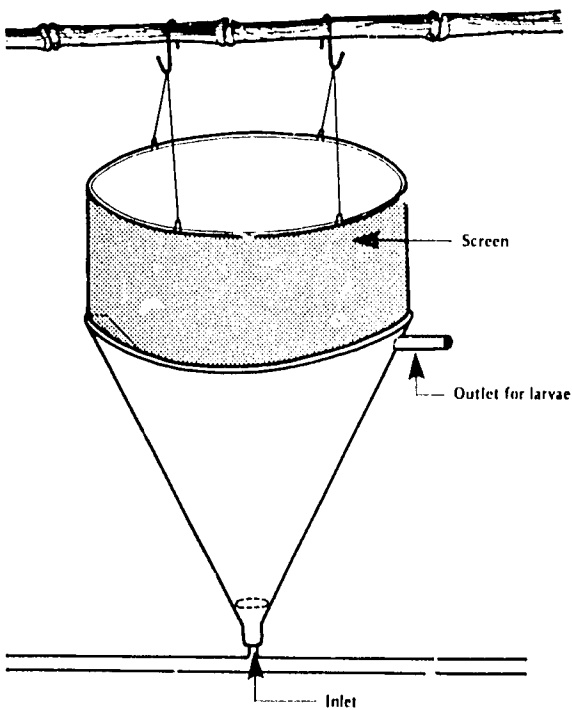

Fig. 2.14

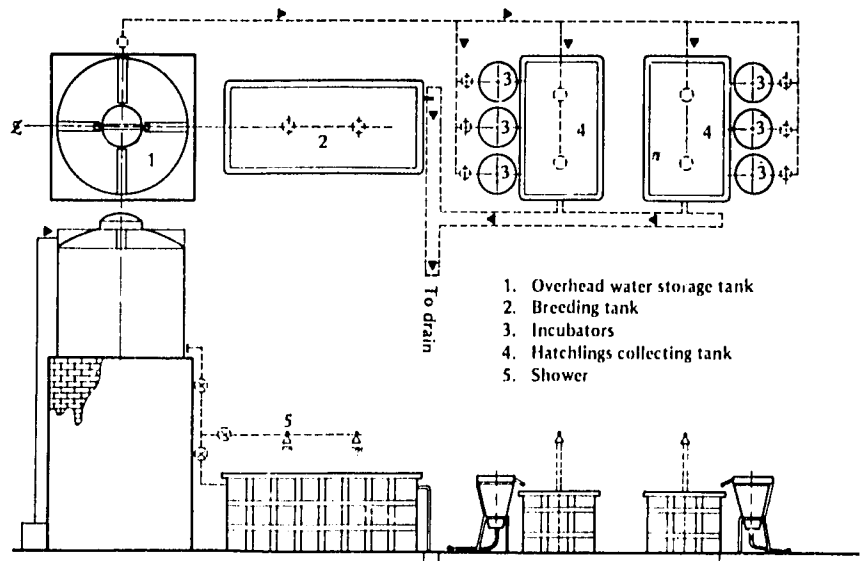

Fig. 2.15

**"DWIVEDI-DESIGNED" HATCHERY OF LOW DENSITY
POLYETHYLENE MATERIAL**

Dr. S.N. Dwivedi of the Central Institute of Fisheries Education, Bombay, has developed a 6-, 12- or 24-hatchery jar (Fig. 2.16)¹ portable modern carp hatchery, all water-holding components of which are made of translucent low density polyethylene material called *Sintex* (sinter plast containers). The advantages of the material are that each item is molded in one piece without seams or welds. In addition, the material is strong, does not corrode, requires little maintenance, is light-weight and easy to install, clean and move. This carp hatchery consists essentially of a breeding and a hatching unit. The breeding unit comprises a cooling tower, large pools with spray shower and a water circulatory system. The system furnishes clear, cool, highly oxygenated water with a gentle current from which metabolites are continually removed. The hatchery unit comprises vertical hatching jars each of 40-liter capacity through which flow filtered water with an oxygen content of 7-9 ppm at 27°C. Both the units are installed in an air-conditioned room (Fig. 2.17). The hatchery provides a high degree of structural flexibility and as breeding and hatching systems evolve and become more efficient, alterations are easy to effect, which is not conveniently possible in reinforced concrete systems.



Fig. 2.16. Hatchery equipment made of low density polyethylene material showing portable hatchery jars and hatching containers among others (reproduced with the permission of Sinter Plast Containers, Bombay).



Fig. 2.17. General view of a modern "Dwivedi" carp hatchery operating at Khutela Bhata Fish Seed Farm, Madhya Pradesh, India (reproduced from Central Institute of Fisheries Education 1979-1980).

¹Obtainable from: 18 World Trade Centre, Cuffe Parade Bombay 400005 (India) Cable Address: ROTO-PLAST.

For operating hatching jars having water supply from above, jar tank units (Fig. 2.18) may be installed. A jar tank unit consists of a rectangular brickwork cemented tank (4 m x 1 m x 3/4 m) to hold about 3,000 liters of water. Over the brickwork cemented tank may be placed planks in pairs to support a certain number of hatchery jars also arranged in pairs, with a discharge arrangement into the brickwork cemented tank located directly below the wooden planks (Figs. 2.19 and 2.20).

The various hatching methods described above have their own merits, demerits and limitations. These are mentioned in Table 2.5 in a comparative manner.



Fig. 2.18

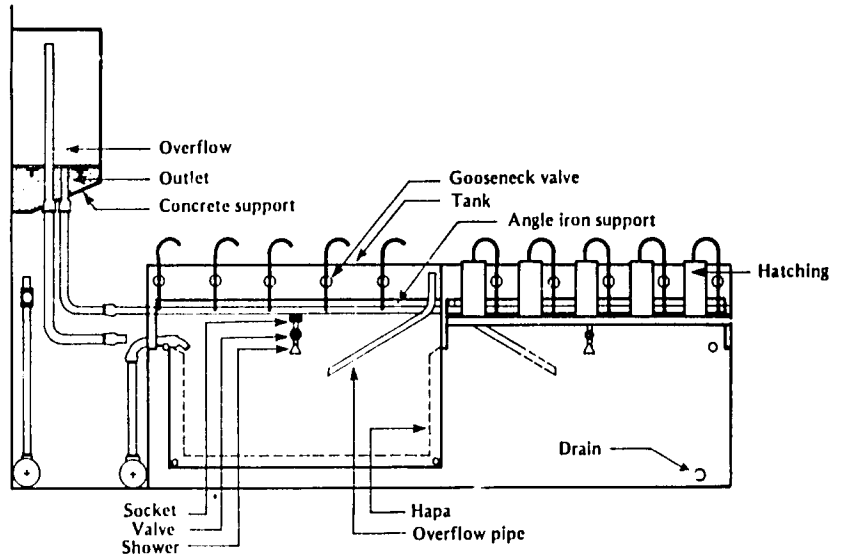

Fig. 2.19

Fig. 2.18. Plastic hatching jars with water supply from above at the Raipur Carp Hatchery, Noakhali, Bangladesh (reproduced from a photo by one of the authors). Fig. 2.19. Side section of a jar-hatchery at the Raipur Carp Hatchery (from Snell et al. 1979). Fig. 2.20. A cemented hatchery tank located directly below the hatching jars at the Raipur Carp Hatchery (from Snell et al. 1979).

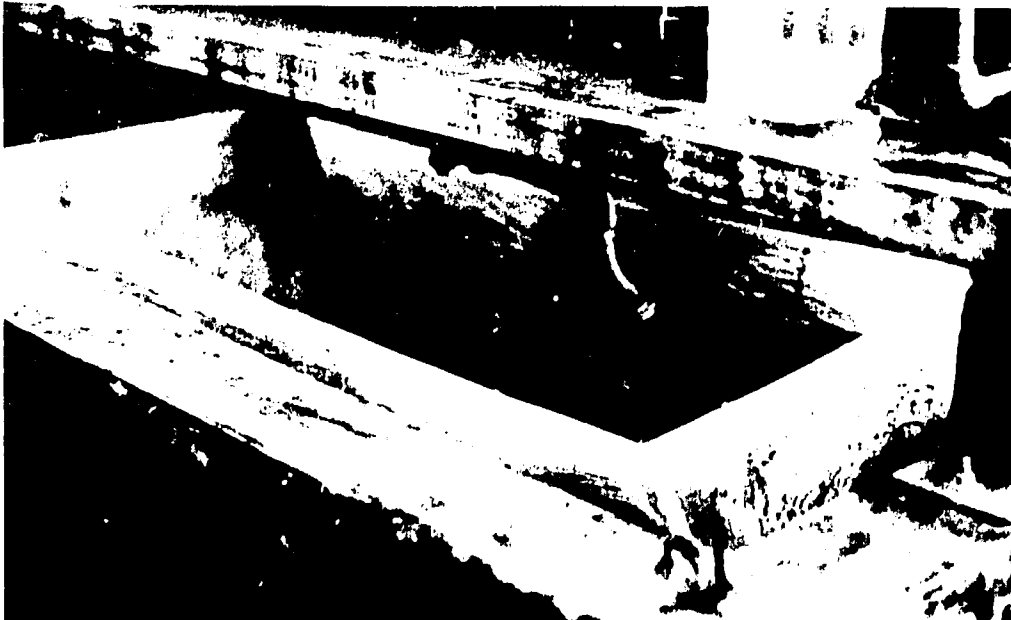

Fig. 2.20

Table 2.5. Merits and demerits of different hatching methods.

Hatching Method	Merits and Limitations	Demerits
Double-walled hatching cloth <i>hapa</i> installed in still-water ponds	<ol style="list-style-type: none"> 1. Useful for hatching relatively small number of eggs. 2. Separates egg shells from hatchlings very effectively. 	<ol style="list-style-type: none"> 1. Water quality cannot be controlled, exposed to outside environmental conditions which may lead to mortality. 2. Fish from water outside the <i>hapa</i> can suck or otherwise damage and even destroy eggs and hatchlings—through the <i>hapa</i> wall. 3. Needs frequent replacement because cloth submerged in water gets spoiled.
Funnel-shaped canvas hatching devices provided with flowing water	<ol style="list-style-type: none"> 1. Small-scale hatching operations are possible. 2. Water quality can be controlled. 	<ol style="list-style-type: none"> 1. There is a limitation as to volume of individual funnel. 2. Developing eggs are not subject to view and easy examination. 3. Discarded egg shells and hatchlings remain mixed up in the same space.
Jars with flowing water supply from below	<ol style="list-style-type: none"> 1. Can be of diverse volumes and hence adaptable to large-scale operation. 2. Eggs and larvae are subject to view and easy examination. 3. Do not require much water. 4. Of simple design and less expensive. 5. Water quality can be controlled. 	<ol style="list-style-type: none"> 1. There is a limit to magnitude of operation. 2. Need constant vigil and care. 3. If made of transparent plastic, may, with use, become translucent and opaque and then would need replacement. 4. Can break if made of glass unless of non-breakable glass which is very expensive.
Jars with flowing water supply from above	<ol style="list-style-type: none"> 1. Same merits as in respect of jars with water supply from below. 	<ol style="list-style-type: none"> 1. Of complex design and expensive. 2. Need constant vigil and care. 3. If made of transparent plastic, may, with use, become translucent and opaque and hence would need replacement. 4. Can break if made of glass, unless of unbreakable glass which is very expensive. 5. Hatchlings are cut off from direct view.
Circular cemented tank with running water supply	<ol style="list-style-type: none"> 1. Adaptable to large- or very large-scale operation. 2. Within limited space, provides effect of some aspects of riverine environment which is the natural habitat of carp. 3. Distribution of oxygen in centrifugal flow of water uniform hence hatching is more effective. 4. Water quality can be controlled. 5. Additional aeration within pool possible. 6. Combines functions of breeding, hatching and larvae rearing tank. 	<ol style="list-style-type: none"> 1. Requires large quantity of water for effective functioning. 2. Monitoring of fertilization and hatching not possible. 3. Defects in levelling in the draining system especially links with hatching tanks are impossible to repair without dismantling the brickwork. 4. Separation of egg shells from hatchlings cumbersome and not very effective. 5. Expensive to install. 6. Not portable.

Continued

Table 2.5. (continued)

Hatching Method	Merits and Limitations	Demerits
Rectangular cemented tank with running water	<ol style="list-style-type: none"> 7. Lends itself to modular design. 8. Care-free automatic operation with no special vigil required to watch operation. 1. Adaptable to large- or very large-scale operation. 2. Provides some aspects of riverine conditions. 3. Distribution of oxygen not uniform because of dead areas at curves or angles, hence, not very effective in hatching operations. 4. Water quality can be controlled. 5. Additional aeration within pool possible but not very effective because of shape. 	<ol style="list-style-type: none"> 1. Requires large quantity of water. 2. Monitoring of extent of fertilization and hatching not possible. 3. Defects in levelling in drainage system requires dismantling to repair. 4. Separation of egg shells from hatchlings not possible. 5. Relative to circular tank less expensive to install. 6. Not portable. 7. Does not lend itself to modular design very effectively because of shape.
Low density polyethylene hatching system—"Dwivedi" hatchery	<ol style="list-style-type: none"> 1. Adaptable to large-scale operation but not to very large-scale operation. 2. Water quality can be controlled. 3. Provides some aspects of riverine conditions. 4. Distribution of oxygen uniform, hence, hatching effective. 5. Additional aeration possible. 6. Extremely easy to repair and mend without dismantling anything. 7. Not expensive to install. 	<ol style="list-style-type: none"> 1. The only drawback is that it cannot lend itself to very large-scale operation. 2. Requires vigil and care to operate.

Operational Procedures of a Hatchery Proper

Whether the table-top kind or jar-tank kind, the hatchery proper still remains a small-scale unit. For large-scale commercial production of carp seed, a system comprising the ante- or holding tanks and circular tanks, combining the functions of spawning, hatching and fry rearing tank in one, is the best and most effective system so far developed.

The following operational procedures are to be observed for managing these two tank types systems:

1. Before releasing any broodfish, the ante-tank should be filled with pond water and an antiseptic substance like potassium permanganate or acriflavin added.
2. To prevent broodfish from jumping out, the ante-tank should be covered with netting having heavy weights (like seine-net-sinkers).
3. Only filtered, clear, cool, clean and oxygenated water at 27°C should be used in circular tanks.

4. Its water level and outflow should be controllable by operating turn-down pipes.
5. The rate of flow of water in the circular tank should be 30-45 liters per minute.
6. There should be a net cover with sinker-like weights for the breeding tank which should be used to cover the tank after the broodfish have been injected and released in it.
7. To safeguard against unexpectedly early breeding after injection (or occasionally even without injection) screens should be put in position.
8. After spawning has taken place, a circular air diffuser should be installed at the base outside the screen and air from compressor or blower bubbled to keep the screen free from eggs.
9. Spawners must be removed from the circular tank after eggs have been completely spawned. They may be given prophylactic treatment in ante-tanks before releasing in a broodfish pond or spent fish pond for possible subsequent maturity.
10. After hatching has occurred, the rate of flow of water through the circular tank should be increased to 45-50 liters per minute and a 6-8 mm meshed nylon net stretched across the tank in a slanting position to collect the discarded egg shells. The nylon net should be retrieved every few minutes to collect cast-off egg shells.
11. If the clogging caused by egg shell bits is not remedied, the central screen fitted into the drain should be carefully replaced by a new one.
12. The hatchlings may be left in the circular tank for four days if a second shift of egg nursing is not to be undertaken. If a second shift is to be undertaken within this period, then the hatchlings should be seined off and removed to the ante-tank.
13. It is essential to periodically brush and hose-wash the screen and keep it completely clean after it has been used once in a breeding tank for a few continuous days.

Larvae Rearing Tank: If the breeding tank is not to be used as a hatching tank and for further rearing as a larvae rearing tank, then the eggs have to be transferred from breeding tank to the hatching tank, and later the hatchlings have to be transferred to larvae rearing tanks before either their packing for transport or for stocking into nurseries for further rearing into fry.

Mention has been made of a modular type of design in which circular breeding tanks may automatically lead to circular hatching tanks. In this design, the latter may also be made to lead to larvae rearing tanks (Fig. 2.6).

This system can work very effectively if the relative levels and capacities of breeding, hatching and larvae rearing tanks are correctly adjusted, but this is often difficult to achieve in a practical hatchery.

When the fry stage has been reached, i.e., after the yolk has been mostly absorbed and the young fish begin to require exogenous food, the young fish have to be taken out of the hatchery. In some fish farms, the transfer from breeding tank or hatchery jars or funnels to the larvae rearing pond for conditioning before transport is automatically done. For automatic transfer of hatchlings to the rearing pond, the outlets of the breeding tank have to lead to outdoor earthen nurseries in which *hapas* are installed.

If the conditioning and further rearing of the hatchlings is to be done inside the hatchery building, then suitable basins for larvae rearing have to be provided. A set of 1.2 m x 1.2 m x 1.2 m basins may be made and hatchlings nursed therein for further development and growth.

Broodfish Care

Care bestowed on the nurture of broodfish is the key to the success of induced spawning of the Chinese and Indian major carps. On it depends such vital processes as onset of maturity, full development of gonads and response to hypophysation. Also affected are the extent and rates of ovulation, fertilization and hatching, and the health of hatchlings and even their survival and growth. Under extreme cases of improper broodfish care, gonads may not develop in the adult fish to any appreciable extent.

Sources of Broodfish

In Chapter 2, a distinction was made between a stock pond and a broodfish pond. The functions of the two are different. A stock pond is devoted to growing and fattening of the fish to marketable size whereas a broodfish pond is meant to hold fish in preparation for spawning. Maturing fish netted from a stock pond can also be a source of fish for the broodfish pond. Other sources of indigenous fish for the broodfish pond can be capture fishery waters such as rivers, lakes and reservoirs. In the case of exotic species (such as all Chinese carps in South and Southeast Asian countries), the only sources of broodfish, at least for the time being, are the stock ponds of fish farms and hatcheries.

Characteristics of Broodfish Ponds

A broodfish pond, depending on the magnitude of operations, may vary in area from 0.2 ha to 2.5 ha and, for the sake of ease of netting operations, should be of a rectangular shape, with width not exceeding 25 m. Its water depth may vary from about 1.5 m to about 2.5 m. A broodfish pond must not only be drainable but should be such that it can be subjected to periodical flushing with good clean water and be amenable to treatments of manuring and fertilization of its bottom for generation of plankton, particularly zooplankton, for proper gonadal development. An alternate source of cool water (25°-27°C) which may be an underground source like an artesian well, should be available to flush the broodfish pond. This facility sometimes conditions broodfish better for induced breeding. While the advisable range of stocking of a broodfish pond is 1,000 to 3,000 kg per hectare, the lower rate of 1,000 kg per ha is preferable and should be used when space is available. Pond shape, size, depth and rate of stocking have been specified in Chapter 2.

The number of broodfish ponds in a hatchery depends on methods of dealing with different species. The alternatives open are: (1) nurture of a mixture of broodfish of both sexes of all the species of Chinese and Indian major carps in the same pond; (2) segregation of a combination of two or more species of both sexes in the same pond; (3) segregation of both sexes of a single species and (4) sex-wise segregation of different species in separate ponds.

Fish species which breed naturally in a pond must be kept separately from those which do not since the former require segregation by sex in order to avoid

uncontrolled spawning. Among the fishes under consideration in this Manual, the common carp, *Cyprinus carpio*, is the only naturally breeding fish under pond conditions; the rest need to be induced to breed in captivity. Further, the breeding season of common carp is often, at least partly, different from those of Chinese and Indian major carps. Since common carp breeders must be segregated sex-wise, separate ponds are required for females and males of this species. As to the rest of the species, any of the four above-stated alternatives can be adopted. Nurture of different species of broodfish of Chinese and Indian major carps in one and the same pond is problematic since in a community broodfish pond, only common artificial feeds can be administered, whereas, the natural food and artificial feed requirements of the different species are separate for their respective proper gonadal development. Therefore, since the primary aim of broodfish ponds is to allow proper gonadal development of spawners, more especially the development of ovaries in the females, broodfish care is best done if the different fish are kept segregated, single species-wise and sex-wise. If the sexes of the brood Chinese and Indian major carps are individually segregated in separate broodfish ponds, the females would need much greater care at higher rates of feeding than the males.

In the unavoidable necessity of combining species owing to lack of space, the following combinations of species would be acceptable because of feeding complementarity (for further information on current practices see Table 8.19, Chapter 8): (1) broodfish of silver carp may be co-stocked with those of rohu or common carp but silver carp broodfish should not be stocked together with rohu and common carp in the same pond; (2) broodfish of grass carp may be co-stocked with those of catla or bighead carp but grass carp broodfish should not be stocked together with catla and bighead carp in the same pond; (3) bighead carp, catla and silver carp, which have overlapping feeding habits, should not be co-stocked in the same broodfish pond. If they are so stocked owing to overriding considerations of pond space, the zooplankton feeders (bighead carp and catla) should proportionately be much less than the silver carp. It is, however, preferable to separate the broodfish of planktophagous species from each other and stock them in individual broodfish ponds according to species and sexes.

If pond space is extremely limited, it may become necessary to have one or more community stock ponds (see Chapter 2). Apart from saving space, such a community pond would allow fuller use of different ecological niches and enable specimens of different species to be procured for breeding operations through common seining operations. Should it become necessary to co-stock Chinese and Indian major carps in one or common broodfish pond or ponds, their ratios may be approximately as shown in Table 3.1, with the overall stocking density remaining at 1,000 kg/ha to 3,000 kg/ha.

The difference in the stocking ratios of different species mentioned in Chapter 2 is because of absence of common carp in the community broodfish pond.

Adult catla often shows poor gonadal development. There is evidence that this can be caused by insufficient space. Catla broodfish need special care which would comprise: monospecies stocking at not more than 1,000/ha in the largest and deepest of the broodfish ponds; special steps like organic manuring; steps to ensure zooplankton production of at least 50 ml per 1,000 liters of water¹ and feeding with

¹The standard limnological method of obtaining a vertical or horizontal haul of a standard plankton net and measuring the exact amount of water passing through the net is not applicable in small shallow-water ponds. Here, a known quantity of subsurface water collected in pails from different sections in the pond may be passed through a No. 25 Bolting silk net (79 meshes/linear cm and an aperture size of 0.064 mm) and plankton volume (settlement volume in graduated cylinder) noted down. Qualitative examination may be done in a Sedwick Rafter counting cell (50 mm x 20 mm x 1 mm depth) with 1 mm square rulings.

Table 3.1. Ratios of different species of carps in a community broodfish pond.

Niche/Natural Food	Species	Percentage of Stocking
Surface Feeders		
Phytoplankton	Silver carp	24
Zooplankton	Bighead carp	12
Zooplankton	Catla	12
Bottom Feeder		
Detritus	Mrigal	12
Bottom-Column Feeders		
Browser	Rohu	20
Macro-Vegetation Feeders		
Aquatic Foliage	Grass carp	20
	Total	100

a high protein diet (30%) from which oilcakes may be excluded, over the greater part of the year. While scientific evidence is lacking, it is believed that presence of oilcake in the supplementary feeds of catla tends to deposit fat in association with gonadal tissue in this particular zooplanktophagous fish. A catla brood pond also needs fortnightly flushing with clean freshwater to simulate riverine conditions.

The following management practices should be applied to broodfish ponds, whether stocked with one or more species.

Pond Fertilization and Manuring

The objective of pond fertilization and manuring is to produce a plentiful, sustained supply of plankton and, in the context of broodfish care, more of zooplankton to provide the animal protein required in the diet of the broodfish. The principles and practices of pond fertilization are discussed in Chapter 5 and are fully applicable to broodfish ponds. The cycle of phytoplankton and zooplankton production is linked with pond productivity and growth of fish. Organic manures such as cattle dung, chicken and duck droppings and composted water hyacinth with urea and lime produce zooplankton biomass. It is a sound practice to periodically assess plankton production and to take corrective measures through manuring should the level of production run low. Secchi disc transparency², in otherwise non-turbid waters, can be an added tool to judge plankton production. The entire pond bottom treatment is based on soil chemistry and should be so treated in a hatchery. The objective should be to supply only the missing nutrients in a particular agroclimatic condition.

Feeds

Principles of fish feeds and feeding will be discussed in Chapter 8. Sources of protein, carbohydrates, vitamins and minerals are somewhat variable and are, up to a

² A standard Secchi disc consists of a circular metal plate 20 cm in diameter, the upper surface of which is divided into four equal quadrants, each of them being painted black and white alternately while the lower side of the plate is painted black to eliminate reflection of light from that side. The disc is lowered on a graduated line into the water and the depth (d_1) at which it disappears is noted. Now the disc is lifted slowly and the depth (d_2) at which the disc reappears is noted. The reading $\frac{d_1 + d_2}{2}$ in cm gives a measure of light penetration and is known as Secchi disc transparency.

point, dependent on local availability. For example, soyabean, as a source of protein, is not easily available in all countries; silkworm pupae are available in only a few countries, and only in certain areas within these countries; fishmeal is also not a universally available commodity and its price is highly variable. A possible broodfish supplemental feed includes soyabean, meal, corn and rice bran in the ratio of 60:10:80, respectively, with a total protein content of about 30%. Ingredients and percentage composition of supplemental feed for common carp broodfish are shown in Table 8.18 in Chapter 8.

The feeding rate may be 1% to 2.5% of the body weight of broodfish during the autumn and winter months of September to January depending on water surface available for each broodfish to graze nutrient food. Later, it would become necessary to raise the feeding rate (feed remaining the same) to 5% of the bodyweight of the fish. Feed should be administered once a day, every day of the week and at a fixed time and fixed location. It may be handmade or pelletized and may be hand-broadcast or served through feeders. Some aspects of feeds for broodfish are mentioned in Chapter 8.

A hatchery should have a timetable for broodfish and broodfish pond maintenance operations. The tasks to be performed are shown in Chapter 12 under "Broodfish and spent fish care".

There is a practice followed in China for conditioning broodfish of Chinese carps aimed at minimizing broodfish mortality in induced breeding operations. This practice comprises drag-netting broodfish into a corner of the broodfish pond and putting them in a net enclosure for about one hour and letting them go. This process is repeated for two to three days before the day when induced breeding of the fish is planned. The spawners are transported in narrow, deep carriers made of canvas from the broodfish pond to the hatchery proper.

SPECIAL DIETARY CARE OF BROODFISH

Special dietary care is required for the different species of broodfish. Guidelines are given below, as far as known.

1. *Grass Carp*: The spawners of grass carp are to be fed once daily, during autumn and spring, on wheat and paddy sprouts, corn grains and bean cakes in equal proportions at 1-2% of their body weights besides macrovegetation at 100% of their body weight. The first-mentioned feeds are believed to enhance fecundity of grass carp and promote proper gonad development.

2. *Bighead and Silver Carp*: For these planktophagous fish, fertilization with organic manures at the rate of 1.5 to 2 tonnes per hectare every ten days is recommended. Should the gonad development remain poor, supplementary feeding with powdered bean cakes, peanut cakes and wheat or rice bran in equal proportion at 1-2% of body weight per day may be given.

3. *Catla*: For proper gonadal development of catla (besides the earlier mentioned precaution of monospecies stocking and flushing of broodfish ponds), organic manuring with cattle dung and/or chicken and duck droppings, and production of zooplankton at 30-50 ml per 1,000 liters of water are very important. Artificial feeds containing soybean meal and/or fish meal (30%) with rice bran or wheat bran but without oilcakes administered at 3-5% of body weight daily is important.

4. *Mrigal, Rohu and Common Carp*: These species are by and large bottom dwellers and are naturally detritus eaters or browsers. Feeds based on soybean meal, rice bran or wheat bran and oilcakes in equal proportions at 3-5% of body weight per day benefit their gonadal development. An alternate feed at 3-5% of body weight per day is a mixture of wheat bran, mustard oilcake, coarse wheat flour and fish meal or soybean meal in the ratios of 4:4:1:1. Mustard oilcake, if used, should be presoaked (for softening) in water overnight.

Breeding Seasonality

It may be possible to breed any of the Chinese or Indian major carps more than once in one breeding season, especially if the first breeding is done very early in the breeding season, leaving long days in the season to provide the requisite photo-period regime for the gonads to ripen, given proper feeds. For repetition of breeding of the same broodfish, the spent fish need to be stocked in one or more separate tanks, and the same care as stated above is needed to help them attain sexual maturity again. The approximate breeding seasons of cultured carps in some selected Asian countries are given in Table 3.2.

Table 3.2. The approximate breeding seasons of cultured carps in selected Asian countries (for further information within countries, see Chapter 1).

	Common carp	Chinese carps	Indian major carps
Bangladesh	<ol style="list-style-type: none"> 1. February-March 2. Monsoon months 3. October-November (In central and lower Bangladesh) <ol style="list-style-type: none"> 1. April-May 2. September-October (In upper non-mountainous region) 	March-June	Mid-May-August
Burma		—	June-August
Indonesia	Throughout the year	—	—
Nepal	<ol style="list-style-type: none"> 1. February-March in Terai area 2. March-April (In Kathmandu Valley) 	March-May in Terai Mid-May to June in Kathmandu Valley	June-August in Terai (depends on monsoons)
Pakistan	<ol style="list-style-type: none"> 1. March-April 2. September-October 	—	June-Mid-August
Sri Lanka	<ol style="list-style-type: none"> 1. February-April 2. July-August 3. September-October 	(Main Breeding) <ol style="list-style-type: none"> 1. October-December 2. July-August 	(Main Breeding) <ol style="list-style-type: none"> 1. October-December 2. July-August

Chapter 4

Induced Spawning of Chinese and Indian Major Carps

The Indian major carps and the Chinese carps breed naturally only in the flowing waters of their natural habitat, the rivers, in association with the monsoon floods. Until the introduction of the technique of induced breeding, the only source of their seed for aquaculture was the rivers. The riverine carp spawn invariably is a mixture of seed of desirable and undesirable species of fish and its availability entirely depends on the vagaries of the monsoon. On the other hand, induced breeding produces seed of absolute purity and, at the present stage of the technical development of induced breeding, allows at least partial independence from the monsoon. It also opens the possibilities of stock improvement by selective breeding and hybridization. The progress of carp culture in recent years is almost entirely due to the development of induced breeding techniques.

Stages of Maturation of Adult Carps

Seven stages of gonadal maturation of carps are commonly recognized. The stages and their characteristics are shown in Table 4.1.

After the third stage of maturation has been reached, further development of ovary is very fast, especially in increasing day-length and rising temperature. By the time Stage V is reached, the ovarian weight may be 20-30% of the total body weight (i.e., gonado-somatic index: 20-30). In males, the gonadosomatic index may be 5-10 at Stage V of maturation. Common carp exhibits a more pronounced ovarian development than Chinese or Indian major carps with females showing a gonado-somatic index of about 30 and males, 20-30.

While sexes in these carps are morphologically different, the sexual dimorphism they exhibit externally is only relative and not infallibly distinct even in the breeding season. The more important external distinguishing features of ripe female and male Chinese carps and Indian major carps are shown in Table 4.2 (characteristics of mature common carps are listed under the section "Common Carp Breeding" in this Chapter).

Determining Readiness for Spawning

The morphological features described in Table 4.2 can be taken as indicators of ripeness. However, a more reliable method of determining whether or not the female fish is ready for spawning is to draw an egg sample from the posterior end of the ovary by means of a catheter. A catheter, for this purpose, is a glass tube of 2 mm diameter with a short flexible tubing attached to one end to permit easy movement. The catheter is inserted into the genital aperture and probed to reach the posterior extremity of the ovary. An egg sample is then sucked into the glass tube and transferred to a glass bowl into which a solution of 70% acetic acid and 30% alcohol is

Table 4.1. Stages of gonadal maturation of carps.

Stage of maturation	Condition of gonad	
	Female	Male
(1)	(2)	(3)
I Immature	A transparent, long, narrow strip	Transparent, thread-like
II Immature	Thickened strip, translucent	Translucent, thread-like
III Maturing	Opaque, granular, somewhat greyish, occupying about 1/3 of the body cavity	Opaque, pinkish white, thin, strip-like
IV Maturing	Dull greyish in color, ova discernible like granules, occupying about 1/2 of the body cavity	Thick strip, milky, oozing whitish fluid on applying pressure on belly
V Mature	Dull grey to greenish, occupying almost the entire body cavity, ova distinctly round in shape	Thickened band like oozing whitish fluid on applying pressure on belly
VI Spawning	Having loose eggs in ovarian wall, eggs oozing through genital sperture on applying pressure on belly	Oozing milt freely on applying pressure on belly
VII Spent	Ovary blood-shot, pinkish brown mass but greatly shrunk	Oozing milt freely on applying pressure on belly

Table 4.2. External distinguishing features of sexes of carps.

Female	Male
(1)	(2)
1. Pectoral fin relatively small and weak with the outermost ray not very thick.	1. Pectoral fin relatively long and prominent with well-developed thick outermost ray.
2. Inner surface of the pectoral fin, facing the body, is smooth to feel by touch.	2. Inner surface of the pectoral fin, facing the body, is rough to touch.
3. Abdomen shows a conspicuous bulge which extends past the pelvis up to genital aperture. Abdomen soft to touch. No median ridge in front of vent. Bulge in the abdomen may also be due to fat deposit around the gut and is not a foolproof indication of mature gonads.	3. Abdomen does not generally show a conspicuous bulge and is not very soft to touch. Abdomen shows median ridge in front of vent.
4. Genital aperture is protruding and swollen (Fig. 4.1), turgid, shows pinkish margins. A pinkish genital pore may also be found among fish which have begun to regress. (This method is particularly difficult to apply to grass carp.)	4. Vent not protruding; pit-like in appearance.
5. Ova visible inside genital aperture when gentle pressure applied to abdomen. Vent may also be swollen and reddish.	5. Milky white milt exudes through genital aperture on applying gentle pressure to abdomen.
6. Body stouter in appearance relative to male of same age adult.	6. Body thinner and linear in shape relative to adult females of same age.

immediately poured, immersing the ovarian ova sample. Within about 5 minutes, yolk becomes discernible and so also the nuclei of individual ova. Acentric or peripheral location of nuclei is a sure indication of readiness of the fish for spawning. In gametogenesis, the nucleus of the ovum migrates to the periphery before release of the first polar body in meiosis. Should, however, the ova nuclei be found to be centrally located, then such a fish would not respond to hormonal breeding treatment.

Induced Spawning of Chinese and Indian Major Carps

The most commonly adopted technique of induced breeding of carps is hypophysation. It involves injecting mature female and male carps with extracts of pituitary gland taken from other mature fish generally phylogenetically close to carps. The pituitary gland (hypophysis) is an endocrine gland located on the ventral side of the brain of the fish. It may or may not have a stalk of attachment with the brain. In many cases, the pituitary gland is lodged in a distinct depression on the inner side of the cranium of the fish.

In order to prepare fresh extract of pituitary, the gland has to be removed by dissecting the fish. The best way to get at the whole gland is to saw or chop off the



Fig. 4.1. Genital aperture (protruding and swollen) of a mature female rohu.

roof of the cranium horizontally, exposing the brain. The brain is then carefully removed from the cranial cavity with a pair of forceps. This process exposes the pituitary gland (located ventral to brain) from the dorsal side. The gland is then picked up in whole with a pair of forceps (Fig. 4.2). Care has to be exercised to ensure that the gland is not damaged in the process of removal and collection, since otherwise some of the water-soluble gonadotropins may be lost.

If the gland is not to be used immediately for preparation of an extract for fish breeding, it may be preserved. The preservation of whole glands is an important step to ensure retention of their potency. Only entire glands should be preserved. The tissues that may be attached to the gland should be removed and the glands either preserved in absolute alcohol or acetone-dried.

If pituitary glands are preserved in absolute alcohol, airtight vials should be used and, after being kept in this medium for 24 hours, old alcohol should be



Fig. 4.2. A dissected catla head from the dorsal side to show the pituitary gland.

replaced by new absolute alcohol to ensure proper preservation. The vials then may be stored even at room temperature to retain their potency up to a year but the use of a refrigerator is preferable as it allows the preserved glands to be retained for two to three years without impairing their efficacy.

If acetone-drying is to be done, the glands should be placed in 10 times their volume of acetone, and the latter should be replaced with new acetone after 12 hours. The acetone should be changed again after a further 6-8 hours. After this, the glands are taken out, dried on filter paper and stored in tightly sealed vials for future use. Pituitary glands preserved in this way are known to retain their efficacy for over three years.

There are certain precautions to be taken in choosing the donor fish for collection of pituitary glands. It is best to choose freshly killed fish. Next best is fish freshly preserved in ice or cold storage but preserved well before any spoilage has started. Pituitary glands should be collected only from adult, sexually mature unspent fish. Gonadotropin from pituitary extracts of phylogenetically remote fish such as salmon, tilapia, catfish and even some marine fish has been found to be effective in carps; however, common carp pituitary and homoplastic¹ pituitary are perhaps safest to use.

PREPARATION OF THE INJECTION MATERIAL

In early years of induced breeding, the weights of donor and recipient fish were kept approximately equal. This meant that for spawning a 2 kg female carp, for example, the pituitary gland extract from a donor fish also weighing about 2 kg was necessary. As a result of further research in fish breeding, the required weight of pituitary gland extracted from a donor fish can be calculated based on the total weight of the recipient fish (Fig. 4.3), so that the weight of the donor fish need not be known. A system of two injections has been evolved in which the first injection called a stimulating or priming dose, consists of a preliminary dose of 2 to 4 mg of pituitary per kg of the body weight of the recipient female, followed six hours later, by a second dose, called a resolving dose, of 8-12 mg/kg body weight. In this manner, a total of 10-16 mg/kg body weight is injected to the female spawner. For recipient male fish, a single dose of 2-4 mg/kg body weight is given at the time of the second injection of the female fish. The system of two injections to recipient fish has, by and large, remained unchanged since the early sixties when it was first developed in India. The injection dosages may have to be varied depending on the exact stage of maturity of the recipient fish and water temperature, a relatively lower stage of maturity and cooler water require greater dosages of injections. The extent of variation in dosage is a matter of conjecture in the present day state of technical knowledge of hypophysation of carps.

For injection, the glands should be gently removed from the vial with a pair of forceps, dried on filter paper for about 2-3 minutes if preserved in absolute alcohol, and then weighed on an electric balance. The weighed glands should be transferred to a tissue homogenizer (Fig. 4.4) and thoroughly macerated in a few drops of distilled water. More distilled water should then be added to give about 40 mg of pituitary material per ml of water. The extract is then centrifuged and the supernatant fluid is used for injections. Requisite amounts of fluid according to the weight of the recipient fish may be drawn into a syringe for injections.

¹Homoplastic pituitary: If the donor fish is of the same species as the recipient, the gland is called homoplastic. If, however, the donor fish is a different species (even allied carp), the gland is termed heteroplastic.



Fig. 4.3

Fig. 4.3. A recipient catla female being weighed to determine the dose of pituitary extract to be injected. Fig. 4.4. Carp pituitary gland being homogenized.



Fig. 4.4

INJECTION ROUTES

Injections may either be intramuscular (Fig. 4.5) or intraperitoneal. Given equal degree of dexterity of the worker with both, the quantity of fluid to be injected indicates which of the two routes should be used. The intramuscular route is effective when the fluid to be injected does not exceed two ml. For greater volume, the intraperitoneal route is more appropriate because the peritoneal cavity has much more space in which to hold the injected fluid than does muscular tissue.

Intramuscular injections are generally given between the base of the dorsal fin and the lateral line, at the base of pectoral fin or between the anal fin and lateral line. The fish scale should be lifted for inserting the injection needle, and the area



Fig. 4.5. Intramuscular injection being given to a catla broodfish.

should be gently massaged following the withdrawal of the needle after injection to aid distribution of the extract into musculature and prevent its backflow. Backflow can also be reduced by increasing the viscosity of the fluid; this can be done by adding glycerine in the ratio of 7:3 (water:glycerine). The placement of the needle for the intramuscular injection is unimportant for Indian major carps, but its angle to the base of pectoral fin is recommended as 45° for silver and bighead carps and 90° for grass carp. Intraperitoneal injection may be at the base of either the pectoral fin or the pelvic fin. If it is the former, care has to be exercised that the heart of the fish is not punctured by the needle. It is preferable to use a smaller needle for intraperitoneal injection at the base of the pectoral fin. The size of the syringe and the diameter (gauge) of the needle depend partly on the size of the recipient fish but more so on the volume of the fluid to be injected. Gentle handling of the broodfish during stages in preparation for injection or while injecting is of great importance since bruising, abrasion and scale-loss, or even removal of mucus, renders skin liable to bacterial infection. A carelessly handled fish may not survive long enough to ovulate, whereas a fish that is handled properly may be successfully bred several times. A moist towel can be used to wrap the fish for transport even over short distances. A 0.01% acriflavin dip after handling fish for injection or stripping reduces problems of bacterial infections.

Use of anesthetics during injection would significantly increase the survival of broodfish. Commonly used anesthetics are MS222 (Sandoz) and Quinaldine. MS222 may be added to the water in doses of 50-100 mg/liter or a roll of cotton-filled cloth may be soaked in a 0.04 M solution and inserted in the mouth of the fish. If Quinaldine is to be used as an anesthetic, its dose is 50-100 mg/liter. The injection can also be given while the fish is in water, a process which eliminates the risk of internal injury since the weight of the fish is borne by the water; this may be done either on anesthetized fish or unanesthetized fish held in the folds of a net or towel in a hinged padded fish holder.

In fish farms and hatcheries where artificially controlled environmental conditions are not available, hypophysation work should be done on cloudy or rainy days. The first injection is generally given around 1600 to 1800 hours and the second, six hours later. Such timings generally suit the convenience of workers and the diurnal temperatures are also the lowest when spawning condition of the injected fish is expected (0500 to 0700). These considerations of timing and weather are of vital importance, especially where breeding and hatching tanks are located in the open, as otherwise the mid-morning sun could cause the water of cement breeding and hatching tanks to heat up and destroy the ovulated eggs totally. In locations at higher altitudes, where the ambient air and water temperatures are lower than those on the plains, with cold nights intervening between successive sunny days, sunny days may be chosen for breeding. In such cases, however, soon after oviposition in breeding tanks, the eggs should be transferred to the hatching tank and the flow of water must continue in both, to avoid mortality of the eggs and hatchlings caused by heat. In cases of indoor hatcheries where controlled environmental conditions exist, the above injection schedule need not be followed.

Injected broodfish of Chinese and Indian major carps are released in breeding tanks in appropriately paired sets. Generally, a set is made up of one female fish plus two males whose combined weight approximately equals the weight of the female. In the flowing water of a cemented breeding tank, whatever its shape, spawning and fertilization generally take place naturally within six hours after the second injection of pituitary extract. If six hours have elapsed since the second injection, and spawning has not taken place naturally in spite of the provision of optimal conditions, artificial insemination or stripping has to be used. Many hatcheries have developed specific injection and treatment procedures for different species of fish, especially

the Chinese carps, which necessitate stripping at a specified time after the injections are administered. These procedures are described later in this Manual for each species.

For a female broodfish to be ready for stripping, the hormonal injections must have induced ovulation of the ova within the ovary. This is indicated by a very soft belly condition at any part of the abdomen, and a state of shifting softness should be felt when the worker's hand is moved along the abdomen. Internally, the individual ova must have been discharged from their follicles inside the ovary wall. In this condition when the abdomen is pressed by hand, a jet or spurt of loosened eggs would occur through the genital aperture. For stripping, the female fish is held by the operator between the side of his body and his arm with the fish slanting head up, tail down and belly facing the vessel (Figs. 4.6 and 4.7) and the eggs are collected into an enamel or plastic trough by pressing the body of the fish. The male fish is then similarly held and milt is squeezed out into the same basin as the eggs. Two persons can more easily carry out stripping, with one holding the fish firmly and the other liberating the eggs and milt by turns. At least three persons are required for simultaneous release of eggs and milt. The two sex products are then mixed as soon as possible by means of a feather to allow fertilization to take place. The fertilized eggs are then washed a few times with clean water to remove excess milt and allowed to stay undisturbed in fresh water for about 30 minutes. The eggs are then ready for release in the hatching tanks (Fig. 4.8).

Fig. 4.6. A milt collection syringe being used to collect milt from an adult male carp (reproduced from a filmstrip entitled "Rearing fry and fingerlings of Chinese carps," FAO). Fig. 4.7. Stripping of a female and a male Chinese carp. Fig. 4.8. Fertilized Chinese carp eggs (from Jhingran 1983).



Fig. 4.6

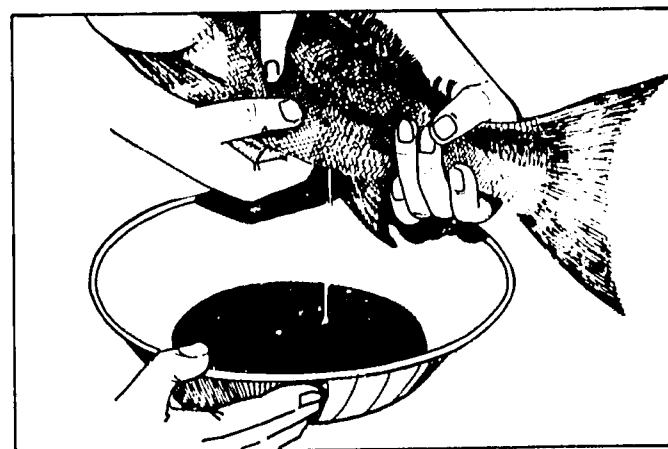
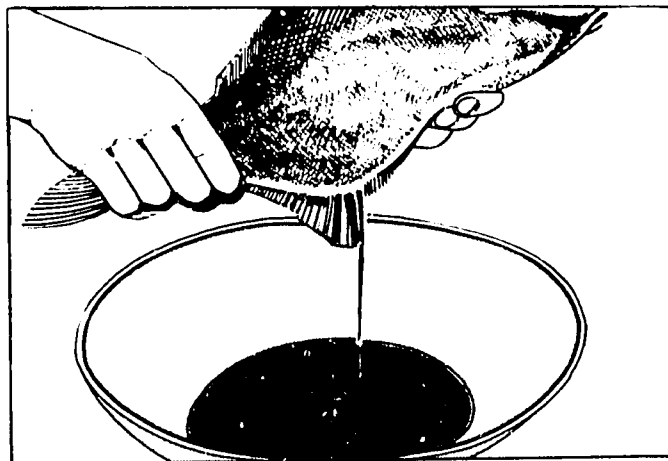

Fig. 4.7



Fig. 4.8

OTHER OVULATING SUBSTANCES FOR INDUCED SPAWNING OF CARPS

The technique of hypophysation has undergone refinements over the years beginning with preliminary experiments performed by Houssay in 1931. At present, hypophysation remains the only realistic choice for the rural fish farmer of Asia, for reasons both economic and technical. It is, however, beginning to appear that the days of hypophysation for carp breeding work are numbered. The problems of hypophysation are mainly those of dosage and the supply of pituitary-based gonadotropic hormones; the former arises out of the crudeness of the technique and the latter, out of supply related to demand (apart from the time and money required for collecting large amounts of pituitary glands from maturing adults of phylogenetically close fish in a short season). Significant developments in this context are the dehydration and ampouling of crude pituitary extract of homoplastic material (Fig. 4.9), attempted establishment of pituitary banks by the Food and Agriculture Organization of United Nations with assistance from the Indian Council of Agricultural



Fig. 4.9. Ampoules containing fish pituitary extract preserved in glycerine.

Research and the availability of powdered crude extract of common carp pituitary from some pharmaceutical companies. These developments do not solve the problem of standardization of dosages for which accurate knowledge of the gonadotropic activity of pituitary extracts and development of suitable bioassay techniques are essential.

Various substances are at the present time used in fish breeding work. In Thailand, pituitary glands from *Tachysurus* sp. and *Trichogaster pectoralis* are also used. Human chorionic gonadotropic hormone (HCG) is also widely employed (Table 4.3) although its excessive use can produce immunological effects.

Silver carp and bighead carps are bred in Malaysia at 25-27°C water temperature by injecting a priming dose of 50 international units (IU) of HCG per kg followed by a stimulating dose of 200/250 IU HCG/kg 12-24 hours later, further followed 6 hours later by a resolving dose of 4 mg/kg of acetone-dried common carp pituitary extract with ovulation occurring 6 hours later. In China, high doses of HCG are used at times for breeding bighead carp, silver carp and grass carp. The doses used are of the order of 500 to 2,200 IU/kg for bighead carp and 800 to 900 IU/kg for silver carp with grass carp needing even higher doses than these.

Table 4.3. Induced breeding techniques of Chinese carps adopted by various workers.^a

Species (country)	Time of year	Age of breeder (years)	Number of females	Water temperature (°C)	Assessment of gonadal state	Substance (route)	Solvent	Injection		ΔT^b (hr)	Delay to ovulation (hr)	Fertilization method	Incubation method	Results	Notes
								First dose	Second dose						
<i>Hypophthalmichthys molitrix</i> (Israel)	—	2-4	60	—	F: enlarged soft belly M: milt on gentle pressure	<i>Cyprinus carpio</i> pituitaries (IM)	0.75% NaCl	—	—	—	—	Stripped: dry	Incubators with flowing water	3 million larvae hatched, 50% survival to 0.25 g stocking size	Injection carried out while fish in water to eliminate trauma
<i>Hypophthalmichthys molitrix</i> (Malaysia)	—	2	12	17-28	F: full, soft belly, swollen, pink cloaca M: milt on pressure	M or F <i>Cyprinus carpio</i> or <i>Puntius gonionotus</i> pituitaries (IM or IP) ^c	0.6% NaCl	F: 5-6 mg/kg wet weight	F: 5-6 mg/kg N: 5 mg/kg	5	5-6	Stripped: dry	In hatchery trays with running water; in ponds: stagnant <i>hapas</i>	Hatchlings in excellent condition for 30% of females injected	Addition of Synahorin to extract has little effect
<i>Hypophthalmichthys molitrix</i> (Malaysia)	—	—	—	25-27	—	HCG plus <i>Cyprinus carpio</i> pituitaries	—	F: 200 IU HCG/kg	F: 4 mg/kg <i>Cyprinus carpio</i> pituitary	6	6-7	—	—	80% successful ovulation	
<i>Hypophthalmichthys molitrix</i> (China)	—	—	198	20-28	—	LHRH-A ^d	Water base	F: 8-10 mg/kg M: 5 mg/kg	—	—	22-24	—	—	84% induced ovulation	
<i>Hypophthalmichthys molitrix</i> (India)	Jul-Aug	—	40	28-34	—	Homoplastic and heteroplastic pituitaries (IM)	—	F: 4 mg/kg	F: 6-10 mg/kg M: 2-3 mg/kg	—	4-5	Stripped: dry	Stagnant <i>hapas</i>	5-80% fertilization: 907,000 fry obtained	Addition of 25-50 IU Synahorin to both female injections also effective. Maximum fry yields associated with rain and cool weather. Best water temperature 27-30°C.
<i>Hypophthalmichthys molitrix</i> (Thailand)	May-Aug	1-2	10	27-33	—	<i>Cyprinus carpio</i> pituitaries plus Synahorin (IM)	0.6% NaCl or distilled water	F and M: 0.23-1 pituitary	F: 1-34 pituitaries plus 20 rabbit units Synahorin	6-8	4-6	Stripped: dry	<i>Hapas</i> in running water	67.7% ovulation	

Continued

Table 4.3. (continued)

Species (country)	Time of year	Age of breeder (years)	Number of females	Water temperature (°C)	Assessment of gonadal state	Substance (route)	Solvent	Injection First dose	Injection Second dose	ΔT^b (hr)	Delay to ovulation (hr)	Fertilization method	Incubation method	Results	Notes
<i>Ctenopharyngodon idella</i> (Malaysia)	—	2	10	27-28	—	M or F <i>Cyprinus carpio</i> or <i>Puntius gonionotus</i> pituitaries (IM or IP)	0.6% NaCl	F: 5-6 mg/kg wet weight	F: 5-6 mg/kg M: 5 mg/kg	5	5-6	Stripped: dry	In hatchery trays with running water; in ponds: stagnant <i>hapas</i>	Hatchlings in excellent condition for 40% of females injected	State of maturity of females cannot be assessed by gut shape due to presence of mesenteric fat
<i>Ctenopharyngodon idella</i> (China)	—	—	25	20-28	—	LHRH-A	Water base	F: 5-10 mg/kg M: 2.5-5 mg/kg	—	—	15-20	—	—	88% spawning	Total 139 fish treated with LHRH-A under various injection regimens, with a resulting overall spawning rate of 86.3%
<i>Ctenopharyngodon idella</i> (India)	Jul-Aug	—	11	28-31	—	Homoplastic and heteroplastic pituitaries (IM)	—	F: 3-5 mg/kg	F: 7-10 mg/kg M: 2-3 mg/kg	—	5-6	Stripped: dry	Stagnant <i>hapas</i>	15-80% fertilization; 553,000 fry produced	Combining Synahorin (25 IU) with pituitary extract proved ineffective
<i>Ctenopharyngodon idella</i> (Thailand)	Jul-Oct	1-2	8	27-33	—	<i>Cyprinus carpio</i> pituitaries plus Synahorin (IM)	0.6% NaCl or distilled water	F and M: 0.23-1 pituitary	F: 1-3.4 pituitaries plus 20 rabbit units Synahorin	6-8	4-6	Stripped: dry	<i>Hapas</i> in running water	47% ovulation	
<i>Aristichthys nobilis</i> (Malaysia)	—	2	18	27-28	F: full, soft belly, swollen, pink cloaca M: milt on pressure	M or F <i>Cyprinus carpio</i> or <i>Puntius gonionotus</i> pituitaries (IM or IP)	0.6% NaCl	F: 5-6 mg/kg wet weight	F: 5-6 mg/kg M: 5 mg/kg	5	5-6	Stripped: dry	In hatchery: trays with running water; in ponds: stagnant <i>hapas</i>	Hatchlings in good condition for 66% of females injected	Addition of Synahorin to pituitary extract has little effect

Continued

Table 4.3. (continued)

Species (country)	Time of year	Age of breeder (years)	Number of females	Water temper- ature (°C)	Assessment of gonadal state	Substance (route)	Solvent	Injection		ΔT^b (hr)	Delay to ovulation (hr)		Fertilization method	Incubation method	Results	Notes
								First dose	Second dose							
<i>Aris- tichthys nobilis</i> (Malaysia)	—	—	—	25-27	—	HCG plus <i>Cyprinus carpio</i> pituitaries	—	F: 200 IU HCG/kg	F: 4 mg/kg <i>Cyprinus carpio</i> pitu- itary	6	6-7	—	—	80% success- ful ovulation		
<i>Aris- tichthys nobilis</i> (China)	—	—	108	20-28	—	LHRH-A	Water base	F: 1-2 mg/kg M: 0.5-1 mg/kg	F: 8-9 mg/kg M: 4-4.5 mg/ kg	12	—	—	—	82% induced ovulation		
<i>Aris- tichthys nobilis</i> (Thailand)	Aug-Sep	1-2	5	27-33	—	<i>Cyprinus carpio</i> pituitaries plus Synahorin	0.6% NaCl or dis- tilled water	F and M: 0.23-1 pituitary	F: 1-3.4 pitu- itaries plus 20 rabbit units Synahorin	6-8	4-6	Stripped: dry	<i>Hapas</i> in running water	91% ovulation		

^aTable based on Harvey and Hoar (1979).

^bT = time between first and second injections.

^cIM = intramuscular; IP = intraperitoneal.

^dLHRH-A = (D-Ala⁶-Des-Gly-NH₂¹⁰)-LH-RH-ethylamide.

To circumvent the un-bioassayed character of the extract of whole pituitary glands, the weights of donor and recipient fish are equated in Hong Kong in the ratios of 0.9:1.4, 1.0:1.3 and 1.0 to 1.6 for bighead carp, silver carp and grass carp, respectively, and in Thailand, in the ratios of 0.4:1.0; 0.3:0.7 and 0.5 to 0.7 for the same fish, respectively. The amounts of extracts required for induced spawning of phylogenetically distant species are greater than for more closely related species; for example in Malaysia, bioassayed salmon gonadotropin was found to be much less effective on Chinese carps than common carp pituitary extract.

Research is currently underway on a number of other substances, such as synthetic luteinizing hormone-releasing hormone analogues (LH-RHA), clomiphene citrate, tamoxiphen, progesterone, DOC (deoxycorticosterone), which show some promise as ovulatory agents. At the present time, it appears too early to give firm recommendations regarding these substances.

Based on knowledge gained from different countries, preferred hormonal treatments to the female spawners of different species of Chinese and Indian major carps may now be recommended. The males in every case to be injected at the time of the second injection to the female.

PROTOCOLS FOR PITUITARY INJECTIONS TO INDUCE SPAWNING IN INDIAN MAJOR CARPS

- Rohu** : A priming dose of 2 mg/kg of broodfish at 1600 to 1800 hours followed by a resolving dose of 8 mg/kg, 6 hours later. Natural spawning may be expected 4 to 6 hours after the second injection. Optimal water temperature is 27°C, within the acceptable range 24°C to 31°C. Rohu is not intolerant to warmer water within its acceptable temperature range.
- Catla** : A priming dose of 1-2 mg/kg at 1600 to 1800 hours followed by a resolving dose of 6-8 mg/kg, 6 hours later. Natural spawning may be expected 4 to 6 hours after the second injection. Catla is very intolerant to warm water and should be induced to breed during heavy rains when cool weather prevails. In the event of warm water spell, catla especially should be exposed to cool hatchery water of 27°C to 28°C for an additional day in the ante- or storage tank before breeding by hypophysation.
- Mrigal** : A priming dose of 1-1.5 mg/kg at 1600 to 1800 hours followed by a resolving dose of 6 mg/kg, 6 hours later. Natural breeding may be expected 4 to 6 hours after second injection. Optimum temperature required by mrigal is 27°C within the range of 24°C to 31°C. Mrigal is not intolerant to warmer water temperature within the acceptable temperature range.

In Indian major carps, if it is necessary to strip, because natural breeding did not take place on time, or if it is desired to hand-strip to obtain fuller oviposition, the injection venue may be changed to the ante-tank, administering both the injections at the same dosages as in the case of natural breeding. The fish should be examined for the freely oozing condition and softness of belly and stripping done between 4 to 7 hours after administering the resolving dose.

PROTOCOLS FOR INDUCED SPAWNING OF CHINESE CARPS

A wide variety of substances and procedures of their use have been adopted by different workers for successful breeding of silver carp, bighead carp and grass carp.

The various protocols tried in respect of different species of Chinese carps are shown in detail in Table 4.3.

Common Carp Breeding

UNCONTROLLED BREEDING OF COMMON CARP

Common carp differs from Chinese and Indian major carps in its faculty to breed naturally in ponds provided that some aquatic vegetation is available for attaching its adhesive eggs and that environmental conditions are favorable. The fish breeds throughout the year in tropical climates (e.g., in Indonesia) with two peak breeding periods, one during spring often lasting from January to April and the other during autumn often lasting from July to October. Where the fish does not breed throughout the year, it generally breeds twice a year during spring and autumn. In Europe, it breeds during the spring and summer months, March to July.

For obvious reasons, the faculty to breed naturally should ordinarily be of great advantage for a cultivated fish. However, there are drawbacks in leaving fish to fend for themselves and allowing them to breed in an uncontrolled manner, particularly high mortality among eggs, hatchlings and fry due to sub-optimal conditions (unsuitable temperature, high levels of predation, etc.). To obviate these drawbacks of uncontrolled reproduction, common carp is bred in aquaculture in either a semi-controlled manner, as is generally the case, or in a controlled manner by hypophysation.

SEMI-CONTROLLED BREEDING OF COMMON CARP

There exist two major semi-controlled breeding systems for common carp in different countries of the world, and one can choose the one most relevant to a given situation. The two systems are the Indonesian and the European. Those followed in other countries fall in one of the other system or are at best minor alterations thereof.

Breeding System Followed in Indonesia

The Sundanese method is the main system of breeding common carp in Indonesia. The others (Tjimindi, Rantjapaku and Central Sumatra systems) are variants of the Sundanese method. In this method, broodfish care, breeding proper and hatching are carried out in separate ponds. Male and female spawners are either segregated in different ponds or in screened-off partitions in the same pond.

The best results in common carp breeding are obtained when broodfish are carefully chosen. The following criteria for mature fish may be adopted for the "big belly" variety of common carp.

1. A fully mature female has an almost rounded, soft, bulging abdomen, with obscured ventral ridge and vent projecting into a small papilla-like outgrowth.
2. A mature female, if kept on its belly, will rest thereon without falling sideways, and when held with abdomen directed upwards, shows a slight sagging on the sides due to the weight of the developed ovaries.
3. Mature males (as in other cases) exude milt when gently pressed on the abdomen.

Broodfish are fed with rice bran, kitchen refuse, corn, etc. Spawning ponds are elongated, 25-30 m² in area and have a hard bottom devoid of mud and silt. The pond is dried for a few days before filling with clean water up to a depth of 50-70 cm. Water is released on the morning of the breeding date and broodfish as well as spawn collectors called *kakabans* are positioned in the afternoon. The Indonesian

kakabans are made of dark horse-hair-like fibers of the *Indjuk* plant (*Arenga pinnata* and *Arenga saccharifera*). For making *kakabans*, the *Indjuk* fibers are washed clean then layers thereof arranged in 1.20 to 1.50 m long strips (Fig. 4.10). The long strips are joined lengthwise (Fig. 4.11) between two bamboo planks 4-5 cm wide, 1.5 to 2.0 m long and nailed together on two sides. For spawning, *kakabans* are kept in a floating position a little under the water surface, propped up on bamboo poles.



Making *kakabans* from split cane and mountain moss, Godavari hatchery, Kathmandu (photo, R.S.V. Pullin).

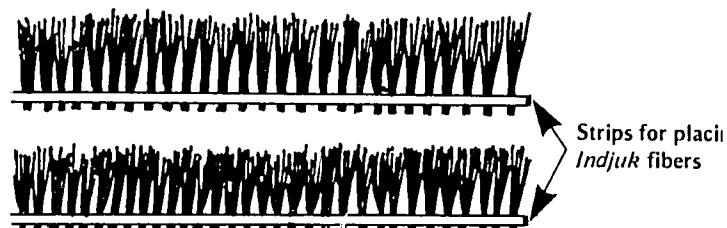

Fig. 4.10

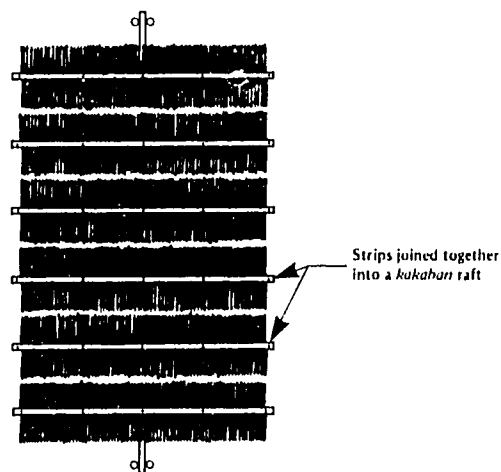

Fig. 4.11

Fig. 4.10. *Indjuk* fibers arranged on bamboo strips. Fig. 4.11. *Kakaban* ready for installation in floating position.

Five to 8 pieces of *kakabans* of the above description are required per kilogram weight of female spawners. A gentle flow of water is supplied in the breeding pond after the broodfish are released and the *kakabans* installed. By habit, the fish first attaches its eggs on the underside of the *kakabans*. When the entire underside is full of deposited eggs, the *kakabans* raft is turned over. When both sides of the *kakabans* are fully egg-laden, they are transferred to hatching ponds which are 20 times larger than the breeding pond. Here, the *kakabans* are placed transversely on floating bamboo poles leaving a gap of 5-8 cm between the fibers of the adjacent *kakabans*. Care is taken that the eggs always remain fully submerged in 8 cm of water. When three weeks old in the hatching pond, carp fry are collected by gradually lowering the water level. The expected yield of fry is 15,000 to 20,000 per kg weight of female spawners.

In the Tjimindi method, which is similar to the Sundanese system, the breeding pond is a small compartment of the hatching pond cornered off by means of a temporary dike.

In the Rantjapaku method, which is also a variant of the Sundanese system, the bottom of the spawning pond is sandy and gravelly. The spawning pond itself is located at a higher level than that of the hatching pond, and the intervening bund between the two ponds is made of stones so arranged that the spawn, but not the spawners, pass throughout the spaces between stones into the hatching pond. In this method, the egg collectors comprise newly cut floating grass and not framed *kakabans*.

In the Central Sumatra method, instead of *kakabans*, spawn collectors comprise scattered *indjuk* fibers spread over about 5 m². Spawners are removed after spawning and fry are collected when only five days old.

Breeding Systems Followed in Europe

The European system of breeding common carp is the Dubisch method. This method uses small ponds, often squarish, measuring about 8 x 8 m, where grasses are grown on the bottom to a height of about 40 cm when the ponds are dry. Dubisch ponds have a peripheral ditch, about 40-50 cm deep, flanking the edges of the pond, which serves as a haven for broodfish and fry. If grasses are not grown in the pond, a special grass-covered spawning board is placed in the pond center. In a variant of the Dubisch pond called the Hofer pond, instead of a peripheral ditch, there is harvesting ditch on one side of the pond. Broodfish are removed from the Dubisch pond after they have spawned. The fry are transferred to prepared nurseries for further rearing about seven days after spawning.

In the Chinese system of breeding common carp, a modification of the Dubisch method is adopted using weeds like *Eichhornia*, *Ceratophyllum* and *Myriophyllum* as egg collectors. To prevent vegetation from drifting away from the spawning area, a squarish bamboo frame is used to contain the weeds.

In India, rarely is a natural pond directly used for common carp breeding. The most commonly used contrivance is a breeding *hapa* (Fig. 2.3) (top lid stitched at all sides except one broadside for release of vegetation and spawners inside) into which aquatic vegetation like *Hydrilla* and *Najas*, at 2 kg thereof per kg weight of female spawner² are uniformly spread to serve as egg collectors. At times *kakabans* made from coconut fibers are used.

Hatching in India is done in hatching *hapas* (Fig. 2.4) into the inner wall of which weeds with eggs sticking to them are released. After hatching, the hatchlings pass through the holes of the inner *hapa* and collect themselves into the outer *hapa*.

CONTROLLED BREEDING OF COMMON CARP

A measure of control on breeding of common carp is obtained by resorting to hypophysation, a system relevant to the species which was developed by Woynarovich (1969). According to this system, ripe female common carp are first anesthetized by inserting in the mouth a *sausage* made with cotton wool dipped in MS222 (0.5 g/50 ml water), and the vent is sutured with waxed cotton thread to prevent inadvertent discharge of eggs when operators are not ready to receive them. Homoplastic pituitary extract at 2.5 to 3.7 mg/kg weight of female spawner, in a normal saline medium thickened with glycerine (70:30 ratio saline:glycerine), is injected following the same procedure as for other carps in respect of both sexes. In unsutured fish, natural ovulation may be expected eight hours after injection at 28°C. Stripping is used to obtain fuller evacuation of the ripe ova.

For proper handling of common carp eggs, it is necessary to remove the adhesive substance which makes the eggs of the species sticky. For this, a solution is made of 10 liters of distilled water, to which 30 g of urea and 40 g of sodium chloride are added. This solution is divided into two equal parts. One-half is gently added to the egg-milt mixture with continuous stirring for 3-5 minutes, the other half is added in small quantities at a time, at intervals of 5 minutes for 1-1/2 hours. The eggs swell up and become water-hardened in the process. To finally remove the adhesiveness of eggs, their entire mass is treated with a solution of tannin in water and the treatment repeated several times. The first treatment is with a solution of the strength 15 g/10 liters of water. One-and-a-half to 2 liters of such a solution is

²For female broodfish weighing over 3 kg, 4-7 kg of egg collectors per kg of female broodfish are released in the *hapa*.

added to the eggs for 10 seconds. The solution is then rapidly removed. This process is repeated with the tannin solution getting progressively weaker. After each 10-second treatment with tannin solution, the eggs need to be washed with pure tap water since tannin is toxic to eggs if left in contact with them for prolonged periods.

Schoonbee and Prinsloo (1984) compared methods for removing carp egg adhesiveness and concluded that a recent improvement of the urea/NaCl method in which the urea concentration is raised to 20 g/liter is most effective (Woynarovich and Woynarovich 1980). An alternative method is to use a suspension of full cream powdered milk at 12-24 g/liter to rinse the eggs. Small fat globules form around the eggs and prevent them from clumping (Schoonbee and Brandt 1982).

HATCHING AND CARE OF HATCHLINGS

Naturally spawned and fertilized eggs of carps, be they common carp or any of the species of Chinese or Indian major carps, if allowed to hatch in stagnant ponds are normally subject to heavy predation and exposure to disease due to infections and physico-chemical hazards of environment such that the percentage hatching may be less than even one. For this reason, fertilized eggs are generally collected after water-hardening and removed to special incubating devices for hatching. Hatching and the care of hatchlings and larval rearing, in fact, constitute the most important aspects of hatchery management and can make all the difference between success and failure of the operations.

A measure of protection from predation is afforded by installing a traditional hatching *hapa* (Fig. 2.4). In its simplest form, a hatching *hapa* is a double-walled contrivance in which an inner *hapa*, made of a mosquito netting type of material, is installed within an outer one made of whole cloth. Obviously the latter, which has to contain the inner *hapa* is the larger of the two, providing gaps on three sides between the corresponding walls of the two. A *hapa* is generally fixed to the pond bottom by bamboo poles. Floating *hapas* have also been devised.

The advantage of having the inner *hapa* of mosquito netting material is that it helps separate the egg shells from hatchlings. As soon as hatched, the hatchlings wiggle through the meshes of the netting leaving the egg shells on the outer upper surface of the inner *hapa*. The hatchlings accumulate in the outer *hapa* made of whole cloth. For best results in the *hapa* system of rearing, the breeding as well as the hatching *hapas* should be installed in running water, and predation from birds and frogs cut out by providing a cover on the top.

A pond-hatching device, like a hatching *hapa*, suffers devastating consequences from a rise of water temperature as well as a drop of water level. Either can lead to total mortality. A running water supply in a flow-through system, where the rate of flow of water, its temperature and dissolved oxygen content can be controlled, and treatment to control bacterial and fungal infections given are requisites of an efficient carp hatchery.

The various types of hatching apparatus and devices which can be installed in an indoor hatchery have already been described and illustrated in Chapter 2. Any one of the devices available in the hatchery may be used, taking care that clean, oxygenated water of the right temperature at a flow rate of 1-2 liters/minute is maintained in the flow-through system. If different systems of hatching, such as jars and circular tanks, are available for use in the same hatchery, then the choice as to which one to use should depend on the magnitude of the breeding operation to be done. Normally, jars may be used for small-scale operations and circular cement tanks for larger-scale ones. The volume of fully swollen and water-hardened laid eggs of different species (see Chapter 1) may be used in deciding the number of jars or

hatching tanks that are to be put to use assuming enough eggs are added to fill the jars up to about 1/2 their individual capacities.

After the eggs have hatched, the hatchlings may be transferred to larvae rearing tanks or kept in a cloth *hara* for about four days, during which period they need no exogenous food since they subsist on their own yolksacs. Fig. 4.12 shows carp hatchlings with their yolksacs. The hatching jars or the circular breeding tanks must, however, be vacated to provide room for the next lot of eggs and/or broodfish. It normally takes slightly more than three days for the yolksac to be absorbed. During the period when hatchlings are laden with a gradually diminishing load of yolk, they alternate between periods of activity and inactivity, and their movements are vertical. During this period, the mouth of the hatchling is developing but not yet formed.

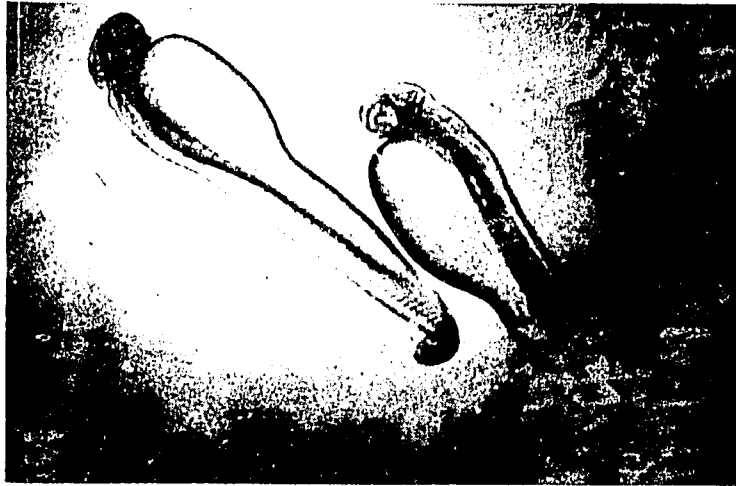

Fig. 4.12. Carp hatchlings shortly after hatching showing the yolksac

The hatchlings must be given appropriate food from an exogenous source a little before the total absorption of their yolksac. In order to test whether or not the hatchlings are ready to take exogenous food, on the third day after hatching, samples of hatchlings should be taken out and their behavior watched in a glass beaker or deep petri dish. The vertical movement of the hatchlings changes into horizontal swimming movement when most of the yolksac is absorbed. As soon as that happens, the hatchlings must be given live and/or artificial food. At the Freshwater Fisheries Development, Training and Extension Station (Balai Budidaya Air Tawar), Sukabumi, West Java, Indonesia, a mass culture system has been developed for rotifers. Rotifers are grown in vigorously aerated water fertilized with dried chicken manure (400 g/m³) and treated with organophosphate pesticides (e.g., Fumadol, 0.25 to 3.0 ppm) to kill cladocerans and copepods. The rotifers are transferred to the post-larval tank by means of air-lift pumps. Figs. 4.13a and 4.13b show the installation of air-lift system in the rotifer production pond. The organophosphate formulations Sumithion 50 EC³, Baytex⁴ and Dipterex⁵ in concentrations 0.25 to 3.0 ppm have similar selective action on rotifers and crustaceans. Much more experimentation

³Sumithion 50 EC Shell Chemicals (500 g Fenitrothion per liter) composition,

00 Dimethyl 0 – (3 methyl – 4 nitrophenyl) Phosphorothioate (Fenitrothion)	50	%
Emulsifier	7	%
Inert ingredients	43	%

⁴Baytex Agrisci Brand: Active ingredient

00 Dimethyl 0 – (methylthio) m – total phosphorothioate	24.37	%
Aromatic petroleum distillate	70.63	%
Generic name: Fenthion	Inert ingredient	5.0 %
Pratt-Gabriel Division, Miller Chemical and Fertilizer Corporation, Hanover PA 17331, U.S.A.		

⁵Dipterex (Bayer)

Active ingredient		
00 – Dimethyl – 2,2,2 trichlorohydroxyethyl Phosphonate	95	%
Inert ingredient	5	%

needs to be done to really develop an effective system of sustained pure dense rotifer culture and to develop a method of their transfer to postlarval tanks. The Indonesian work has given brilliant indicative results. (See Research Problems under Postlarval Nursing in Chapter 11.)

If live food is not available, the first artificial food may be either microencapsulated whole chicken egg or boiled and mashed chicken egg yolk. The former, being whole egg and being in microform, appropriate to the size of the newly formed mouth of the postlarva, is superior. The hatchlings may be kept in the hatchery on egg diet for one to two days, with feeding every two hours, after which they must be transferred to prepared earthen nurseries or otherwise taken care of for further rearing if not sold to pisciculturist customers. The nutritional values of the microencapsulated whole chicken egg and egg yolk diets are mentioned in Chapter 8.



Fig. 4.13a



Fig. 4.13b

Fig. 4.13 a & b. Installation of the airlift system in a rotifer pond at the Balai Budidaya Air Tawar (Development, Extension and Training Wing) of the Directorate General of Fisheries, Sukabumi, West Java, Indonesia.

Chapter 5

Postlarvae and Fry Rearing

Preparation and maintenance of nursery, rearing and stock ponds¹ are important steps in carp hatchery operations. Carp postlarvae and fry are delicate and unprepared or unmaintained ponds may lead to virtual decimation of the stocked material for various reasons stated further in this Chapter. The purpose of nursery, rearing and stock pond preparation before stocking and maintenance after stocking is not only to remove the causes of poor survival, growth and health of the stocked material but also to optimize good husbandry factors for rearing the young of the species concerned.

Larval rearing in a carp hatchery has two distinct phases:

1. rearing of postlarvae to the fry stage, usually in nursery ponds and
2. rearing of fry to the fingerling stage, usually in rearing ponds.

In exceptional cases, these steps are combined in one pond. However, instead of rearing postlarvae to fingerlings in the same pond continuously over three to four months, it is a better practice to break it up into two operations in two different types of water bodies, nursery and rearing ponds, as stated above. This is because there are differences between the postlarvae and fry in their food, stocking rates and environmental requirements.

However, factors which cause mortality, poor growth and ill health are, in great measure, common to both types of ponds. These are:

1. physico-chemical incompatibility of the water of the hatchery proper and that of the nursery pond into which postlarvae are transplanted and likewise, disharmony of the waters of the nursery and rearing ponds (both need acclimatization in the respective ponds);
2. lack of adequate amounts of the requisite kind of fish food in nursery and rearing ponds;
3. predatory aquatic insects and other unwanted biota which naturally abound in all pieces of freshwater bodies unless purposefully eradicated;
4. predatory fish, especially the young of catfish (e.g., *Wallago attu*, *Ompok bimaculatus*, *Clarias* spp. etc.), murrels (e.g., *Channa* spp.) and featherbacks (e.g., *Notopterus chitala*) may be present in the ponds and water supply sources;
5. cannibalism among carp young, especially when postlarvae and fry of different sizes are co-stocked;
6. sudden rise (or fall) of water temperature especially in cement or concrete tanks or earthen ponds with severe seepage problems accentuated when the water depth of the ponds is small;
7. excessive growth of aquatic macro-vegetation and phytoplankton and possible depletion of dissolved oxygen particularly during nights and/or after several

¹Nursery, rearing and stock ponds are defined in Chapter 2. Supplemental feeding with artificial feeds is covered in Chapter 8.

continuous rainy and cloudy days, causing asphyxiation of fish on the one hand and supersaturation of oxygen during hot sunny days causing gas embolism among fish on the other;

8. inherent toxicity of certain algal blooms;

9. afflictions by ecto- and endoparasites; bacterial, fungal and viral infections resulting in disease and mortality;

10. abnormalities and ill health arising out of nutritional deficiencies.

To prevent the above maladies and create wholesome fish husbandry conditions, firstly, the nursery and rearing ponds should be designed to conform with the requirements such as drainage facilities depth, provision of filtration system, monk, and sump described in Chapter 2, since without these facilities the objective of pond preparation and maintenance cannot be achieved.

The next step comprises adoption of the measures in the sequence stated and at timings specified in the following account of nursery pond management. These measures fall into three categories:

1. steps to be taken before stocking postlarvae in the nursery ponds;

2. procedures to be adopted during stocking;

3. steps to be taken after stocking until the production of fry and their harvesting either for sale or for further rearing into fingerlings in rearing ponds.

Pre-Stocking Practices

GROWING A SHORT-TERM CROP OF A LEGUMINOUS PLANT ON THE POND BOTTOM

For preparing nursery and rearing ponds before stocking, it is desirable to sow a short-term crop of a leguminous plant (peas, beans, clovers, etc.) and after it is grown, to plough and level the pond bed so as to incorporate the plants with their roots into the pond soil. This process, called "green manuring",² enriches the pond soil with nitrogen (most legumes fix atmospheric nitrogen). This practice is believed to be beneficial for enhancing pond productivity by nitrogen enrichment and resulting in high survival and fast growth of stocked fish. However, the usefulness of nitrogen as an added fertilizer (which is different from growing leguminous plants) has been questioned because phosphorous and potash fertilizers give equally good results in enhancing productivity. These concepts are discussed further in the section of inorganic fertilization. There is no information available on the optimum density for sowing the leguminous plants or on quantities of legumes required to make an impact on pond productivity.

APPLICATION OF TOXICANTS TO ERADICATE UNWANTED FISH

This step in pond preparation should be taken about three weeks before the anticipated date of release of postlarvae (see Postlarval nursing, p. 147-148). Derris powder, with 5% rotenone content, at a dose of 4-20 mg/l, is perhaps the commonest pond toxicant used. For application, the required quantity of derris powder to make the recommended dose in the volume of water present in the pond is mixed with some amount of water and sprayed over the water surface of the nursery or rearing pond, keeping it well-mixed during the process. Depending on the dosage used, the toxic effect of derris powder may last up to 12 days.

Besides derris powder, which is ordinarily not available in most of the South and Southeast Asian countries unless imported and kept handy in stock, a number

²Green manuring is a special process of incorporation of nodules present on the roots of leguminous plants into pond soil and should not be confused with the use of land vegetation as a pond fertilizer as shown in Fig. 5.1.

of toxicants of plant origin can be successfully used for control of trash fish. Some of the toxicants of plant origin, besides initially acting as piscicides, at a later stage (after their initial toxicity has been used up to kill fish) also fertilize the water. Oil-cake of the plant, *Bassia latifolia*, commonly called *mahua* in India, at a dose of 200-250 mg/l, gives a complete kill of predatory and weed fishes³ within 10 hours. Its application should be at least two weeks before stocking the ponds with carp hatchlings. The toxicity of *mahua* oilcake, at doses of 200-250 mg/l, may last for 72 to 96 hours. Tea-seed cake can also be used to rid ponds of wild fish, tadpoles and insects. For use as toxicant, the tea-seed cake is first ground, soaked overnight to soften and then applied at the rate of 525 to 675 kg/ha. Since tea-seed cake at this dose raises pond acidity, quicklime (calcium oxide) at an additional dose of 150 kg/ha should be used to remedy the situation (see liming, p. 64). Where the purpose of applying lime is to serve as a general disinfectant or precipitation of excess dissolved organic matter, then it should be broadcast over the pond water surface.

For thorough disinfection of a pond, a dose of 10,000 kg/ha of quicklime is required, but if liming has been regularly done annually in the past, 100-200 kg/ha are enough unless the pond soil is very acidic or very poor in carbonates.

Quicklime alone can be used in place of a toxicant to kill wild fish, insects and tadpoles and additionally bestowing on the pond the other benefits of liming. For this purpose, a dose of 900 to 1,050 kg/ha of quicklime is necessary if there is little water in the pond. If the pond is full, the dose of quicklime should be increased to 1,575 to 2,250 kg/ha.

Successive treatments with quicklime and tea-seed cake, the former in the dose of 1,575 to 2,250 kg/ha and the latter 525 to 675 kg/ha, followed by a second quicklime treatment at the rate of 150 kg/ha give most effective results in killing unwanted pond biota, including predatory and weed fish as well as in giving the benefits of liming.

The calcium requirements of pond soils are best determined by soil pH, as seen in Table 5.1.

Table 5.1. Pond soil pH and requirements in hundreds of kg/ha of different forms of calcium.^a

Soil pH	Calcium oxide/ha			Calcium carbonate/ha bottom pond muds
	Clay or loam	Loamy sand	Sand	
4.0	40	20	12.5	60-120
4.0 to .45	30	15	12.5	48-96
4.5 to 5.0	25	12.5	10.0	36-72
5.0 to 5.5	15	10	5	30-48
5.5 to 6.0	10	5	2.5	16-30
6.0 to 6.5	5	5	0	14-16

^aAfter Hora and Pillay (1962).

Other substances which are of tested and proven value as fish toxicants are powdered seed kernel of *Croton tiglium*⁴ (3-5 mg/l), powdered root of *Milletia*

³Weed fishes is a general term for all small-sized fishes which compete for food with carp young. Larger weed fish even prey on carp young.

⁴Its toxicity lasts for 48 hours. In other toxicants mentioned in this paragraph, the duration of toxicity is not known.

pachycarpa (2-6 mg/l), powdered seed of *Barringtonia accutangula* (20 mg/l), powdered unripe fruit of *Randia dumetorum* (12 mg/l) and powdered bark of *Walsura piscidia* (10 mg/l).

Following Ramchandran's (1963) work on the use of anhydrous ammonia gas through an applicator mainly to control aquatic weeds, Subramanian (1983) showed that releasing ammonia through a mixture of calcium hydroxide and ammonium sulphate in the ratio of 1:1.8 (without using an applicator) brought about a kill of many predatory and other unwanted fish. Ammonia, after the kill, acts as a fertilizer, sparing the application of other nitrogen fertilizers.

LIMING

The advantages of liming a pond are numerous. In general, liming enhances pond productivity and improves its sanitation. It is both prophylactic and therapeutic. Specific advantages are that liming:

1. kills pond bacteria, fish parasites and their intermediate life-history stages; hence, especially efficacious in a pond where there has been outbreak of an infectious disease;
2. builds up alkaline reserve and effectively stops fluctuations of pH by its buffering action;
3. renders acidic waters usable for aquaculture by raising their pH to alkaline levels;
4. neutralizes iron compounds which are undesirable to pond biota including fish;
5. improves pond soil quality by promoting mineralization;
6. precipitates excess of dissolved organic matter and thus reduces chances of oxygen depletion;
7. acts as a general pond disinfectant for maintenance of pond hygiene.

The commonly available and used forms of lime are calcium carbonate (ground limestone), calcium hydroxide (slaked lime) and calcium oxide (quicklime). Calcium carbonate dissolves slowly and is of special value for pond fertilization and building up alkaline reserve also leading to calcium enrichment. Quicklime rapidly binds acids and influences pH rapidly, producing results similar to other forms of lime in half the quantity.

Lime can be applied to the pond bottom, added to water at inlets or uniformly broadcast on the water surface depending on the form of lime used and the purpose of application. Calcium hydroxide and calcium oxide are best applied on the pond bottom after it has been drained.

POND FERTILIZATION

The next step in nursery preparation is fertilization, the objective of which is the sustained production of adequate quantities of zooplankton which form the natural food of carp hatchlings and fry.

In the early days of carp culture, the production in a nursery of any species of zooplankton, whether a cladoceran, a copepod or a rotifer or a protozoan regardless of size, was considered adequate. However, in recent times it has become clear that the postlarvae of carps survive and grow best if they are fed on smaller planktonic forms like free-living protozoa and rotifers; and that fry and fingerlings, whose mouths are bigger than those of postlarvae, grow best if fed on larger planktonic organisms like cladocerans and copepods. In fact, it has long been known that some species of copepods prey on carp larvae and postlarvae. Methods of producing pure or nearly pure cultures of rotifers are dealt with later in this Chapter.

For production of zooplankton, nursery ponds are treated either with organic manures (such as cattle, pig or chicken manure) alone and/or with inorganic fertil-

izers such as NPK mixtures. If both organic manures and inorganic fertilizers are used they may be applied either one following the other or as a mixture.

Organic Manuring

If animal manure is to be used alone, its dose should depend on the fish toxicant used for the eradication of unwanted fishes. If the fish toxicant used is *mahua* oil-cake or tea-seed cake, which as stated earlier, have manurial value, the pond is initially manured generally with only 5,000 kg/ha of dry or near dry cattle manure about two weeks before the anticipated date of stocking followed by repetition at the same dose seven days after stocking. But with other toxicants, which have no manurial value, cattle manure should be applied at an initial dose of 10,000-15,000 kg/ha about two weeks before the anticipated date of stocking followed by further manuring at the rate of 5,000 kg/ha seven days after stocking. These manurial rates produce enough zooplankton for a single crop of postlarvae stocked at 1.5 million/ha. If two or more crops of fry are to be produced from the same nursery pond, then the pond should be fertilized with 2,000 kg/ha of cattle dung about a week before each subsequent stocking. If poultry manure is to be used instead of cattle manure, one-third the dose of the former is sufficient since it is at least three times richer in their nitrogen, phosphorous, potassium and calcium than cattle or pig manure.

If organic manures are not available, then commercial compost, as used for agriculture, may be applied as a substitute. The recommended dose for compost is 5,000 kg/ha two weeks before the anticipated date of stocking, followed by 5,000 kg/ha a week after stocking. If, however, compost is to be produced in the carp hatchery itself, then the procedure to adopt is to dig the requisite number⁵ of pits about 4 m x 3 m x 2.5 m deep at an isolated location and dump green vegetation in heaps about 30 cm high, alternating with 7.5 cm high layers of cattle manure, both dusted liberally with calcium superphosphate. A ratio of 10:1 carbon to nitrogen is required for rapid decomposition of vegetable matter in composting. For this purpose, 25 kg sodium nitrate (per 1,000 kg of compost) should be applied with 4,000 liters of water to provide the necessary humidity in the compost pits. The compost should be turned initially three weeks after dumping and thereafter after every five weeks again. Compost may be expected to be ready in a total period of about 12 weeks after filling the pit at temperatures ranging from 18°C to 35°C.

Water hyacinth (*Eichhornia crassipes*) has become a widespread menace in almost all the countries of South and Southeast Asia in recent decades, virtually choking wide areas of still-water masses, canals, drains, etc. The weed can be utilized for composting for use in fish ponds. For composting, 60% water hyacinth, 38% cattle manure, 1% lime and 1% urea, may be dumped in layers one above the other in the compost pits. As an alternative, stacks may also be set up above the ground. In that case, the stacks should be kept covered with plastic sheeting or soil all the time. Water hyacinth compost can be prepared in about 30 days.

Inorganic Fertilization

There is so far no generally accepted method of using inorganic fertilizers in ponds. There is usually a need for nitrogen and phosphorus and (less frequently)

⁵A hatchery's requirements of compost for the year may be estimated according to pond areas at doses given and requisite number of pits dug. This should be incorporated in the annual timetable of tasks to be performed.

potassium which can be made good individually by applying sodium nitrate, superphosphate and potassium chloride, respectively. Generally, however, commercial fertilizers containing known amounts of available nitrogen, phosphorus and potassium are used to make good deficiencies of more than one element. Many combinations of these elements are available as NPK⁶ soil fertilizers, e.g., NPK, 6:8:4 is widely available as is NPK, 16:20:0. NPK, 18:8:4 is common in India. The main point is that these mixtures were developed for *soil*, not water, fertilization. No one has yet worked out critically the mixtures required for pond use. The N:P ratio is the most important aspect—K is far less likely to be limiting. Moreover N and P sources in the pond soil are generally less important than the exogenous amounts needed for good water column fertilization although soil sources are very variable (e.g., Table 5.2). Recent research suggests that a 10:1 elemental N:P ratio is required for phytoplankton. However most soil fertilizers give a much lower ratio. Therefore Swingle (1947) recommended adding 11 kg/ha sodium nitrate to raise the N in his 6:8:4 NPK mixture (applied at 45 kg/ha) to 7.6:8:4 in Alabama ponds. Beyond such general guidelines there are no clear guidelines. Inorganic fertilizers are usually applied in 10 equal monthly installments at 100-500 kg/ha/yr.

Table 5.2. Classification of Indian soils based on available phosphorus and nitrogen (mg/100 mg of soil).^a

	Available phosphorous (P ₂ O ₅)	Available nitrogen (N)
High	6 — 12	50 — 75
Medium	3 — less than 6	25 — less than 50
Low	0 — less than 3	0 — less than 25

^aKhan and Jhingran (1975).

Pond Fertilization with Mixed Organic and Inorganic Fertilizers

A mixture of organic and inorganic manures applied at the following rates has given good results: cattle manure at the rate of 20,000-25,000 kg/ha per year and inorganic fertilizer mix (ammonium sulphate + single superphosphate + calcium nitrate in the ratio 11:5:1) at the rate of 1,380-1,725 kg/ha per year applied in 4-10 equal installments spread over the year.

Fertilization of ponds with organic and inorganic substances may sometimes result in harmful dense phytoplankton blooms. This is traditionally controlled in India by sprinkling liquid cowdung (at the rate of 100 kg/ha) or some other organic matter or by covering the surface of the pond with the duck weed *Lemna*, causing the bloom to die within 4-5 days by preventing penetration of sunlight. Some innovative fish farmers use dense floating mats of water hyacinth (enclosed in a bamboo framework making it a "floating island") to attain the same objective. However, these are empirical practices. Wet cowdung application can lead to excessive rise of BOD⁷ with tragic consequences. Chemical methods of phytoplankton bloom control should be used and are mentioned further in this Chapter.

⁶The ratio N:P:K refers to the ratios of available nitrogen (as N), phosphorus (as P₂O₅) and potassium (as K₂O).

⁷BOD stands for biochemical oxygen demand.

Use of Land Vegetation as Pond Fertilizer

If organic manure and inorganic fertilization are not to be used, land weeds, green grasses and vegetable wastes (especially those with soft stems) make good material for vegetation-based pond fertilizer in nursery ponds. The grasses, at 22,000 kg/ha, are enclosed in a rectangular bamboo-work frame in the nursery pond about a meter away from the bank and allowed to decay (Fig. 5.1). The grasses are turned over in the frame 7-10 days later. Such grasses as have not decomposed and have remained hard are removed.

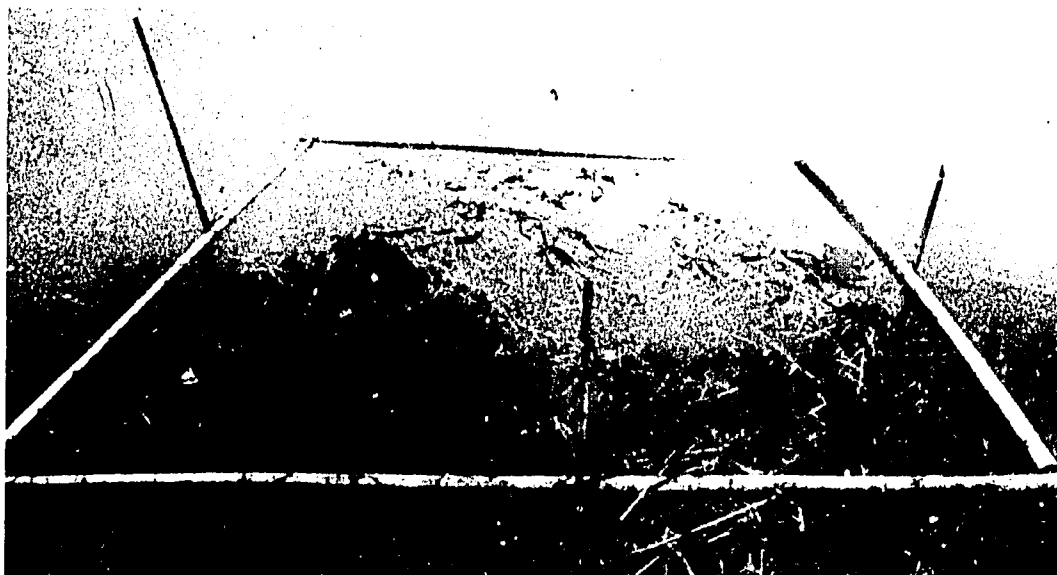

Fig. 5.1. A rectangular bamboo frame for enclosing decaying land vegetation to serve as a pond fertilizer (reproduced from a film-strip entitled "Rearing fry and fingerlings of Chinese carps," FAO).

Subsequent fertilization with decayed vegetation has to be done by additional green vegetation at the rate of 100 to 130 kg/ha every week even after stocking. This is done as often as the pond condition permits, especially the dissolved oxygen level, which may be self-indicated by fry surfacing for gulping in air. Dissolved oxygen should be chemically determined from time to time when organic manuring is being used.

ERADICATION OF PREDATORY INSECTS AND OTHER HARMFUL BIOTA

Nursery ponds more generally than not abound with a large number of aquatic insects over the greater part of the year, especially during and after rains. The more harmful ones preying on carp spawn belong to the insect families Dytiscidae, Gyrinidae, Hydrophilidae, Notonectidae, Pleuridae, Nepidae, Belostomatidae, Corixidae, Gomphidae, Aeshnidae, Agrionidae and Coenagrionidae.

Treatment to be given to nursery ponds for insect control may be any one of the following:

1. Spraying an emulsion of 56 kg mustard or coconut oil and 18 kg washing soap per hectare, 12-24 hours before stocking the postlarvae.
2. Spraying an emulsion (per hectare) of 56 kg of mustard oil and 560 ml of *Teepol*, a detergent synthesized by Burmah Shell.
3. Spraying a mixture of oil extracted from the plant *Calophyllum inophyllum* and *Hertex W.P.*, a water dispersible gammexane. This mixture, which is economical to use, is also very effective against the prawn *Palaemon lamerry*, which often abounds along with insects in nurseries. Further, the mixture does not affect fish postlarvae and zooplankton. The insect kill may be expected within 1/2 to 11 hours depending on the concentration of *Hertex W.P.* which may vary from 0.6 to 1 ppm.
4. Spraying, in the dose of 0.01 ppm, pure gamma isomer of benzene hexachloride dissolved in ethyl alcohol which is highly toxic to insects.

5. Spraying an emulsion of high-speed diesel oil (1 liter), the emulsifier Hyoxid 0.011 (0.75 ml) and water (40 ml) at the rate of about 1 liter of the emulsion for every 200 m² of water surface.

6. Spraying an emulsion of high-speed diesel-boiler oil with any available detergent.

7. Application of 0.25 to 3.0 ppm of the organophosphate substances *Fumadol* or *Sumithion* or *Baytex* or *Dipterex*.⁸ These substances are highly toxic to insects and are believed to be biodegradable. The substance *Sumithion* at 3 ppm, while being toxic to insects, is selectively toxic. Rotifers are virtually immune to it while insects, copepods and cladocerans are not.

Fairy shrimps often appear in large numbers in nursery ponds. If liming has not killed them already, additional liming at 4,000 ppm will eradicate them.

Certain birds, notably cormorants, kingfishers and herons when present are destructive to postlarvae and older fish. Thin lines stretched across the pond are the most effective means of controlling them.

Stocking Carp Postlarvae in Nursery Ponds

JUDGING SUITABILITY OF ENVIRONMENT BEFORE STOCKING

After controlling all factors which might lead to mortality of the stocked carp postlarvae, as described in the preceding section, the most appropriate time for stocking a nursery pond is when it abounds with zooplankton, especially rotifers and cladocerans in adequate density (preferably rotifers only). Before actually stocking the nursery pond with postlarvae, it is necessary to make an estimate of the types and abundance of plankton present. This can be done by adopting appropriate limnological methods. A rough field method for estimating plankton has been developed by Alikunhi (1956) for use by fish farmers. In this method, about 55 liters of water, taken from different sections of the nursery pond, are filtered through an organdy or muslin ring net with a 2.5 cm diameter glass specimen tube tied to the lower end of the net. A pinch of powdered common salt is added to the water in the tube after the plankton is collected and the tube detached from the net. Within 15-20 minutes of adding the salt, most of the organisms settle on the bottom. If the column of plankton sediment is at least 15 mm high from the bottom of the tube and the sediment found to consist mostly of cladocerans and rotifers, the pond may be considered sufficiently rich in plankton to stock at the rate of 1.5 million postlarvae per hectare. The animal or plant nature of plankton sediment is roughly indicated by either a pale-brownish or greenish color of the sediment, the former indicating preponderance of zooplankton and the latter of phytoplankton. If the predominant plankton population be not of zooplankton, then further organic manuring should be done at doses recommended earlier in this Chapter to rectify the situation before stocking.

METHOD OF STOCKING

To avoid any abrupt change in quality and temperature between the water of the hatching tank and that of the nursery pond, the postlarvae should be kept in a suitable container having water initially from the former (hatchery tank) to which the water from the nursery pond should be gradually added in stages, eventually substituting almost the entire hatchery water of the container by the water from the

⁸The short- and long-range effects of the use of these substances on the environment, especially their biodegradability, must be fully studied before they are firmly adopted in aquaculture for regular use.

nursery pond. The container should then be slowly dipped and tilted in the nursery pond so that the postlarvae are free to swim out of the container into the nursery pond. Stocking should be done late in the evening, a procedure which gives postlarvae time to acclimatize themselves during the ensuing night relatively free from depredations of enemies, should any have escaped the steps adopted to eradicate them.

STOCKING RATE OF NURSERY PONDS

The stocking rate of postlarvae in a nursery pond depends on the management practices intended. If natural food in the form of zooplankton is to be produced by continued pond manuring and supplemental feeds are also to be given, and if facilities exist to remedy oxygen deficiency condition should this occur under conditions of heavy stocking, then the stocking rate may be as high as 10 million per hectare.

Post-Stocking Practices

FISH FEEDING

Feeding, described in this Chapter, is based on natural live food organisms generated in the pond itself and augmented through fertilization and on supplemental feeds given exogenously. There is a great deal of difference between complete fish feeds and only supplemental feeds. These fundamental aspects of carp nutrition are described in Chapter 8.

Soon after being stocked in manured nursery ponds containing rich zooplankton, carp postlarvae start grazing voraciously on natural food. At this time the feed requirements of spawn are so large that within two to three days of stocking, the plankton initially present in the pond gets exhausted and steps must be taken not only to generate more natural food but also to administer artificial feeds. The natural zooplanktonic food in the pond is increased by continued manurial treatment already described in a previous section in this Chapter. Supplemental feeding and manurial pond enrichment, when done simultaneously lead to high survival and fast growth of the stocked postlarvae in nurseries. The commonly administered artificial feeds for common, Chinese and Indian major carps are rice bran and oilcakes of ground nut, coconut, mustard, etc. Artificial feeds are always given in finely powdered form to carp postlarvae.

The rate of administering supplemental feeds to carp hatchlings for 15 days of rearing is shown in Table 5.3.

The proportion of different kinds of feeds given to carp postlarvae is shown in Table 5.4.

Table 5.3. Feeding schedule of carp postlarvae/fry for 15 days of rearing.^a

Days after stocking	Feed/day expressed as weight in g of hatchlings at the time of stocking
First 5 days	— equal to double the weight.
6th to 10th day	— double to three times the weight.
11th to 15th day	— three times to four times the weight.

^aAfter Alikunhi (1957); Hora and Pillay (1962).

Table 5.4. Kinds of feeds given to carp postlarvae.^a

Days after stocking	Kind of daily feed as "Cups" ^b			
	Mustard oilcake	Ground nut oilcake	Coconut oilcake	Rice bran
2nd to 5th day	1.0	1.25	2.0	2.0
6th to 10th day	1.5	2.50	3.0	4.0
11th to 15th day	2.0	3.75	4.5	6.0

^aAlikunhi 1956. Reproduced with the permission of Food and Agriculture Organization of the United Nations, Rome.

^bA measure called *Bati* in India for this purpose equivalent to 130-150 ml.

It has been found that among the combinations of various artificial feeds containing protein, fat, carbohydrate, minerals, roughage and vitamins, etc., the maximum growth of postlarvae is obtainable with feeds having a combination of hydrolyzed proteins and carbohydrates (50:30). Complex proteins and pure carbohydrates give poorer results. Further, rice bran alone, a food most often given singly, gives much poorer results than a mixture of oilcakes, rice powder and black gram in powdered form. Silkworm pupae and fishmeal give still better results. These additions to supplemental feeds take one closer to complete diets which are discussed in Chapter 8.

A feed compounded from dried and finely powdered and sieved notonectids (which are highly predatory to carp spawn), small prawns and shrimps and cheap pulses or lentils in the ratio of 5:3:2 gives much better results for survival and growth of hatchlings of catla, rohu, mrigal and silver carp than the conventional mixture of rice bran and oilcake, besides utilizing an otherwise wasted product.

For monoculture of rohu spawn, good results are obtainable with zooplankton, followed by silkworm pupae, mustard oilcake with rice bran and ground nut cake with wheat bran in the order stated.

Normally postlarvae stocked in nursery ponds attain a length 2.0 to 2.5 cm (when they are termed fry) in about 15 days with artificial feeding giving a survival of about 50% in earthen ponds. A higher survival rate may be expected if a system of intensive controlled culture of rotifers and crustaceans to serve as fry food is developed and facilities for intensive aeration are provided. The fry may be transferred to prepared fry-rearing tanks or otherwise taken care of for further rearing if not sold to pisciculturist customers.

Rearing Pond Management

The fry are netted from the nursery ponds and released in rearing ponds which are to be prepared in the same manner as the nursery ponds. The tasks of preparing rearing ponds include: (1) elimination of predatory and weed fishes; (2) manuring with organic and inorganic fertilizers; (3) weed control; (4) stocking with carp fry; (5) supplementary feeding and (6) harvesting. The processes of elimination of predatory and weed fishes and manuring with organic and inorganic fertilizers are identical to those described in the case of nursery ponds. A description for achieving weed control follows.

WEED CONTROL

Being somewhat deeper and larger than nursery ponds, rearing ponds are more liable to get infested with weeds. An overgrowth of weeds deprives the pond soil of nutritive elements, restricts the movement of fish, interferes with netting operations and harbors predatory and weed fishes and insects. Weeds occupying different habitats and niches have to be controlled in different ways.

Floating weeds like *Eichhornia* and *Pistia* are best removed by manual labor. Chemicals like 2, 4-D are quite effective and economical against *Eichhornia*, though not frequently against *Pistia*. When mixed with common domestic detergent, 2, 4-D acts effectively against weeds like *Pistia*, *Nymphaea* and *Nelumbo* in which leaves are either hairy or waxy. Simazine WP-50, applied at 5.6-11.2 kg/ha kills *Pistia*, *Eichhornia* and *Colocasia* completely within two to three weeks even during rains. Taficide-80,⁹ at a dose of 2.2 kg/ha, is also effective against *Eichhornia*.

⁹The short- and long-range effects of the use of 2, 4-D, Simazine WP-50 and Taficide-80 on the environment, especially their biodegradability, must be fully studied before they are firmly adopted in aquaculture for regular use.

Marginal weeds like *Typha*, grasses, sedges, rushes, *Ipomoea*, *Jussiaea*, *Jagittaria* and *Colocasia* are effectively controlled by ploughing in, grazing by livestock, burning during dry season or repeated cutting and deepening or marginal shelves.

Rooted emergent weeds like *Limnanthemum*, *Trapa*, *Myriophyllum*, etc. are successfully removed by repeated cutting of leaves before fruiting at weekly intervals, for about six to eight weeks. Alternatively, spraying once or twice with, 2, 4-D (at 5.6-11.2 kg/ha) kills these plants.

Rooted submerged weeds are cleared by a number of simple, manually operated devices like bottom rakes, log weeders, metal spikes, with or without barbed wire attachment, forks, drag chains or bamboo poles fixed with cross pieces at their lower ends followed by repeated netting with strong wire or rope nets. Other methods employed include shading by floating plants like *Pistia* or *Salvinia* for a period of 8-10 weeks or by creating algal blooms or algal mats by repeated fertilization with N:P:K fertilizers.

Some of the better known fishes that are used for biological control of weeds are the grass carp, *Ctenopharyngodon idella* and *Puntius javanicus*. Grass carp feeds most voraciously on *Hydrilla*, *Najas* and *Ceratophyllum*. It can also control infestations of *Ottelia*, *Vallisneria*, *Nechandra*, *Utricularia*, *Trapa*, *Myriophyllum* and *Limnophila*.

Anhydrous ammonia gas, obtainable in gas cylinders, controls *Hydrilla*, *Najas*, *Wolffia*, *Nymphaea*, *Ottelia*, *Limnanthemum* and *Nelumbo* when injected in the subsurface layers with an applicator at 112-334 kg/ha or 6.9-19 ppm. Much of the ammonia applied enters the pond's production cycle by nitrogen enrichment resulting in phenomenal growth of plankton soon after weed clearance has been achieved with ammonia application (Ramchandran 1963). Recently Subramanian (1983) showed that releasing ammonia through calcium hydroxide and ammonium sulphate in the ratio of 1:1:8 does not need the use of an applicator.

Some blue-green algae, particularly, *Microcystis*, can form long persistent blooms which deplete oxygen and often cause fish mortality. Simazine at a dose of 0.5 to 1.0 ppm clears algal blooms and mats and brings about prolonged control without affecting production of other plankton and fish.

STOCKING OF CARP AND SUPPLEMENTARY FEEDING

For further rearing of carp fry to fingerlings, either monoculture or polyculture in any species combination may be carried out. The stocking density of fry measuring 25.4 mm to 37.8 mm weighing 0.15 to 0.75 g each may be 125,000/ha to 250,000/ha. A practice recommended for healthy fry rearing is that the size of the fry in a rearing pond at the time of stocking should be as uniform as possible. This is accomplished by first segregating the catch in holding pens, made of gunny or canvas bottom and split bamboo sides (Fig. 5.2) supported on stakes. It is necessary to periodically clean the holding pen of debris, fish excreta, etc. which is done by lifting the bottom and removing the rubbish manually (Fig. 5.3). Size grading is done by sifting fry through sieves of different mesh gradations made of split bamboo. Two such sieves used in Taiwan in culture of Chinese carps are shown in Fig. 5.4. The early and advanced fry gradations accomplished by sifting are shown in Fig. 5.5. Fry attain the fingerling length of 100 mm to 172 mm in about three months. A survival of up to 80% may be expected provided that a full complement of management measures for environmental enrichment are adopted and that the fry have natural food as well as artificial feed given to them. Artificial feeding may be on oilcake, mustard or ground nut or coconut and rice bran in the ratio of 1:1. The density of feeding in the first month may be equal to the initial total weight of fry stocked daily and in the second and third months, twice the initial weight of fry stocked daily. If grass carp is among

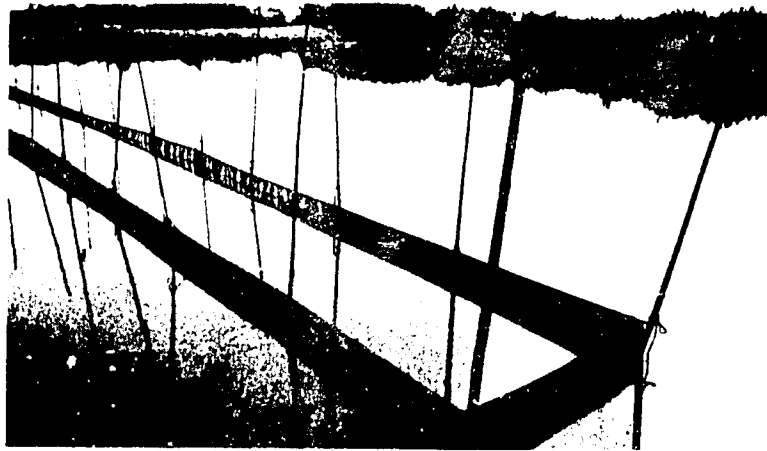

Fig. 5.2. A holding pen.

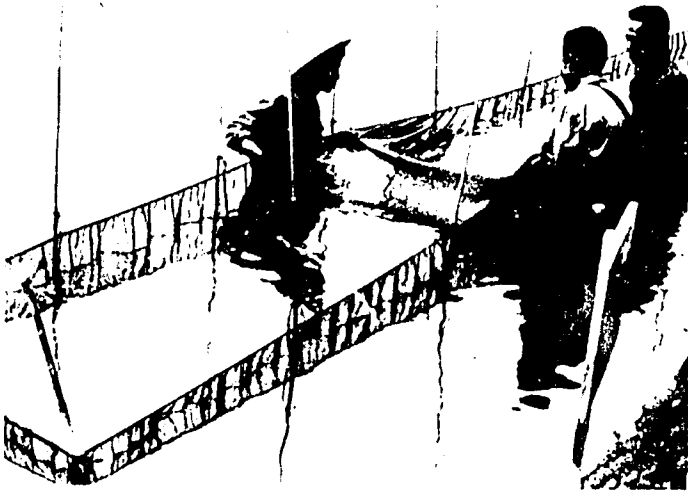

Fig. 5.3

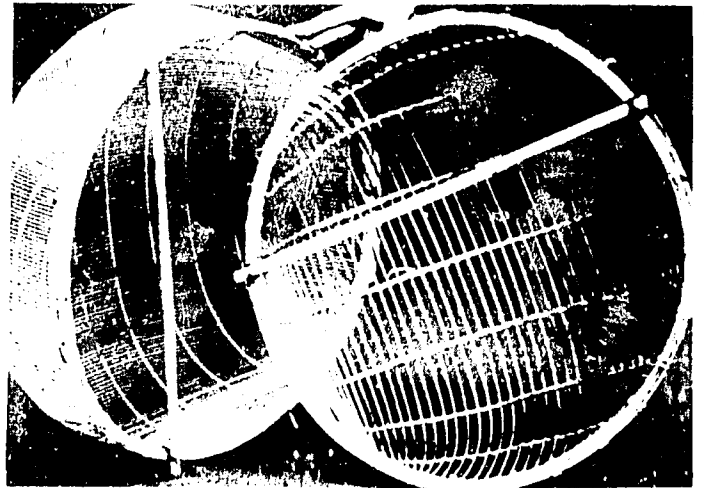

Fig. 5.4

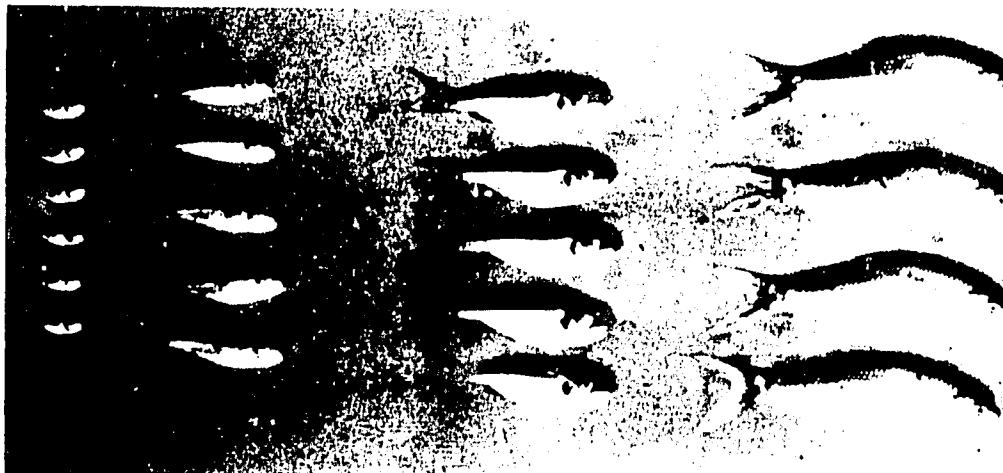

Fig. 5.5

Fig. 5.3. Cleaning a holding pen. Fig. 5.4. Sieves of two different mesh sizes made of bamboo to sift and size-grade carp fry before stocking. Fig. 5.5. Size-grading carp fry by sifting through sieves. All figures are reproduced from a filmstrip entitled "Rearing fry and fingerlings of Chinese carp" (FAO).

the fry in the fish stocked then *Wolffia*, *Spirodela* and *Lemna* may be given as feed at 1,750 kg/ha, twice in a month during the period of rearing. Table 5.5 shows some feeds and feeding rates for Chinese carp fry and fingerlings.

In China, bighead carp, grass carp and silver carp fry/fingerlings are sometimes stunted during holding in nursery ponds. For a 1-ha pond 1.5 m deep, holding one million, 40-100 mm fry/fingerlings of any of these species the stunting diet is 0.5 to 2.0% body weight of rice bran, soybean milk or peanut cake or alternatively 3-5% body weight/day of duck weed. In India also the Indian major carp young are sometimes kept stunted in West Bengal on naturally available food (without fertilization) up to almost a year and stunted fry and fingerlings are available on sale for commencing carp culture operations at any time of the year.

Table 5.5. Some feeds and feeding rates for Chinese carp fry and fingerlings.^a

Country	Species	Area of pond (m ²)	Depth of pond (m)	Size of fish	Age of fish (days)	Stocking rate (no./m ²)	Feed rate	Feeding
China	Big head, grass carp	—	0.5-1.0	up to 20 mm	up to 30	100	Egg yolk paste or soybean milk, plus peanut cake after 10 days	1 egg/2,500-7,500 fry/day or milk from 300-500 g beans/50,000 fry/day
	All species	—	0.5-1.0	20-100 mm	up to 30	—	Soybean meal	45 kg/5,000 fry/month
Hong Kong	All species	1,000	0.8	0.8-3 cm 3 mg-1 g	up to 25-30	150	Soybean milk and peanut cake meal	100 kg soybean milk or 200 kg peanut cake meal/month
	All species	1,400	1.0	3-12 cm; 1.15 g	30-70	35	Peanut cake, rice bran or soybean cake	Start at 1.5 kg/day, build up to 5 kg/day

^aFrom Chang et al. (1983).

The empirical nature of pond fertilization and augmentation of natural food and young fish feeding with locally available material have already been mentioned. It is obvious that until complete young fish feeds are developed by commercial feed companies there can be no definite standardized feeding practices. Additional information based on experimental rearing of carp fry is given in Chapter 8.

HARVESTING

In the case of nursery ponds, harvesting may be done by repeated seining with fine meshed nets. In rearing ponds, where fry are grown to fingerling stage, periodical harvesting may be done at an appropriate time to avoid overcrowding. After harvesting, the fingerlings may be stocked unless sold to pisciculturist customers. The function of a carp hatchery is completed after fingerlings have been produced.

Transport of Live Fish Seed and Broodfish

Two systems are in use for transporting live fish seed and live broodfish. These are: (1) the open system, comprising carriers which are generally open on top, with or without artificial aeration/oxygenation/water circulation and (2) the closed system having sealed, air-tight carriers with oxygen.

Conditioning for Transport

Before packing for transport for short, long or very long¹ durations by either system, the young fish² need to be conditioned to enable them to survive in the restricted space to which they are unavoidably confined during transport. The principle behind conditioning is that the fish should, before packing, rid themselves of all food existing at different stages of digestion in their alimentary canal, the rectal content most of all, before packing and should become accustomed to the conditions of overcrowding prevailing during transport.

Containers for conditioning may be boxes made of nonrustable wire netting of appropriate meshes, bamboo or cane wicker work, wooden barrels or boats with perforated sides and bottoms, enclosures of nylon netting and cloth *hapas*. A cloth *hapa* is perhaps the commonest type of container used for conditioning because of its efficiency, portability, ease of installation on stilts and removal and utilitarian versatility in carp hatchery work. Split bamboo or cane work containers are also very useful but are of more permanent nature.

The site of conditioning may be in a shaded area in a pond to prevent sudden changes in temperature, or in a still water section of a stream or river in about 30-35 cm deep water. The optimum temperature for conditioning carps is between 26-29°C.

The period of conditioning should depend on the size and health of postlarvae, fry and fingerlings, though little information is available on the duration required for conditioning the different stages of carp young and adults. Alikunhi (1957) remarked that conditioning should be done for six hours for the young. Most workers hold the view that it should be for 24-72 hours depending on fish size and health. During conditioning, not only must no natural or artificial food be given to fish, but there should be constant vigorous splashing of water from all directions on the conditioning container. When this is done, the frightened fry pass excreta and even regurgitate food thus emptying their alimentary tracts. No specific information is available on the conditioning requirements of broodfish, but the duration of conditioning

¹Short, long or very long transport are arbitrarily demarcated time durations. The time is short when between packing at one end and release at the other, the time taken is 8 hours, long if it is between 8 and 24 hours and very long if it is between 24 and 48 hours—regardless of the mode of transport, i.e., road, rail or air and the kind of vehicle used.

²Young fish include hatchlings, postlarvae, fry and fingerlings.

should depend on the time required for digestion. (i.e., between ingestion and defecation). However, 48-hour starvation of broodfish is preferable before transportation.

Transport Containers for Fish Fry and Fingerlings

Open containers traditionally comprised earthen vessels in almost every country of the Indo-Pacific region, which were later replaced by metallic vessels. Both needed constant jerking and splashing for aeration and at times change of water during transport, not only once but several times during long transport. These open containers were largely replaced by closed-system containers in the form of glass carboys, especially designed aluminum and galvanized iron sheet boxes (Figs. 6.1 and 6.2) lined with latex foam for holding carp seed under oxygen-pressure, which were

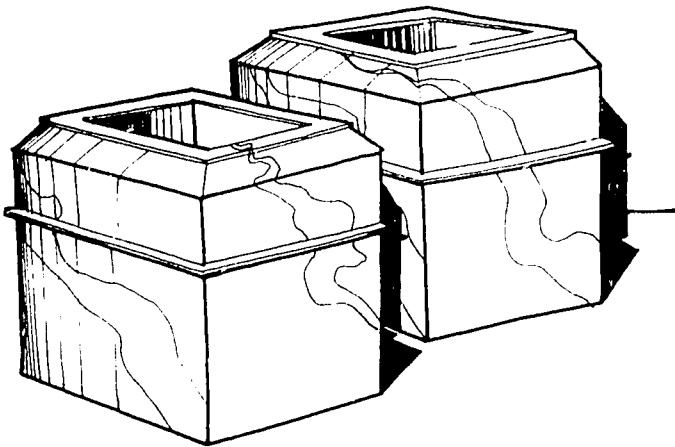

Fig. 6.1

Fig. 6.1. Galvanized iron steel boxes lined with latex foam for holding carp seed under oxygen. Fig. 6.2. Latex foam galvanized iron boxes with oxygen cylinder. Both figures are reproduced from Huet (1972).

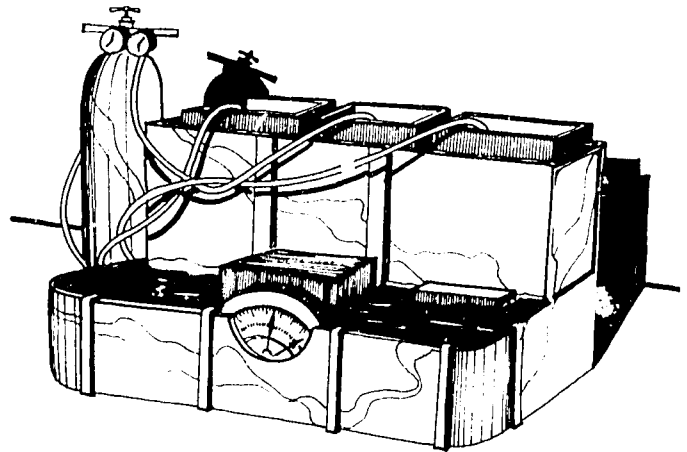

Fig. 6.2

found much more efficient than open containers. These types of containers have, nowadays, been replaced almost universally by polyethylene or other plastic bags (Fig. 6.3).

Polyethylene or other plastic bags of 33-liter capacity measuring 74 cm x 46 cm and made of 0.0625-cm gauge material are currently fairly widely used for transporting carp young. Another bag of smaller volume (16-18 liters) is also widely used. The bags are one-third filled with clear water from pond or river and packed with carp young. Table 6.1 shows packing density of carp fry and fingerlings of Indian major carps for a 12-hour journey in 16-18 liter bags with 15-20 liters of oxygen under slight pressure. No exact information is available on quantity of oxygen per bag except for transport needs of rohu and mrigal fingerlings. Singh (1977) found that the rates of oxygen consumption (VO_2) of rohu and mrigal fingerlings of the length range 10.9-12.6 cm and 9.8-10.0 cm, respectively, and weight range of 10.9-19.5 g and 5.6-8.4 g were 270.8 mg/kg/hr and 179.3 mg/kg/hr, respectively. The estimated amount of oxygen required for 6 hours, 12 hours, 24 hours and 48 hours of transport of the fingerlings of these fish of the above stated length and weight ranges is shown in Table 6.2.

The plastic bag should bloat up with oxygen leaving enough material on top to tie a leakproof knot which will not open by itself during transport (Fig. 6.4). The plastic bag may be sealed by means of a flame.

It is generally advisable to keep each plastic bag individually in containers of cardboard or metal or wooden boxes to prevent leakage by inadvertent damage to

Table 6.1. Packing density of fry/fingerlings of Indian major carps for 12-hour journey in 16-18-liter capacity plastic bags.^a

Size (cm)	Number of Indian major carp fry or fingerlings to be packed in each bag		Average
	Range		
1	1,000	– 10,000	5,500
2	500	– 5,000	2,200
3	200	– 1,000	600
4	200	– 500	330
5	75	– 300	225
6	50	– 200	80
7	25	– 100	70
8	25	– 50	40

^aMammen 1962. Reprinted with the permission of Food and Agriculture Organization, United Nations, Rome.

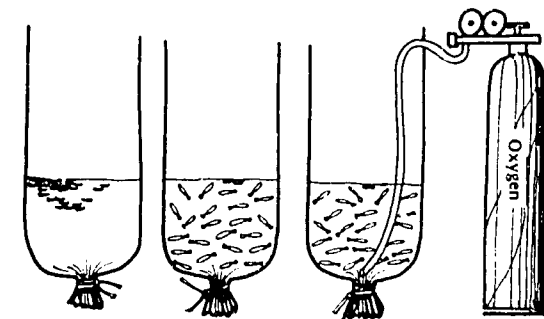

(1) 5-6 l of clean water (2) Put recommended number of young fish (3) Hold oxygen pipe at the bottom

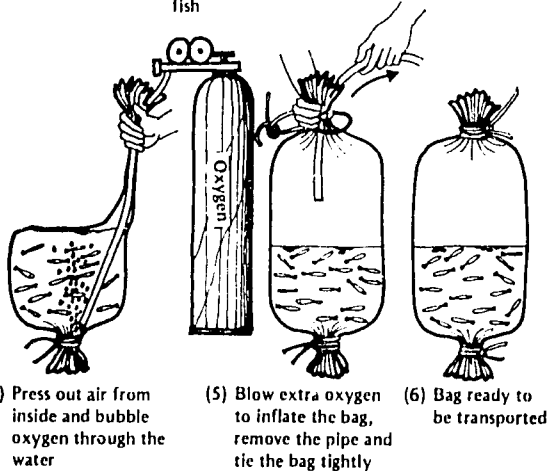

(4) Press out air from inside and bubble oxygen through the water (5) Blow extra oxygen to inflate the bag, remove the pipe and tie the bag tightly (6) Bag ready to be transported

Fig. 6.4

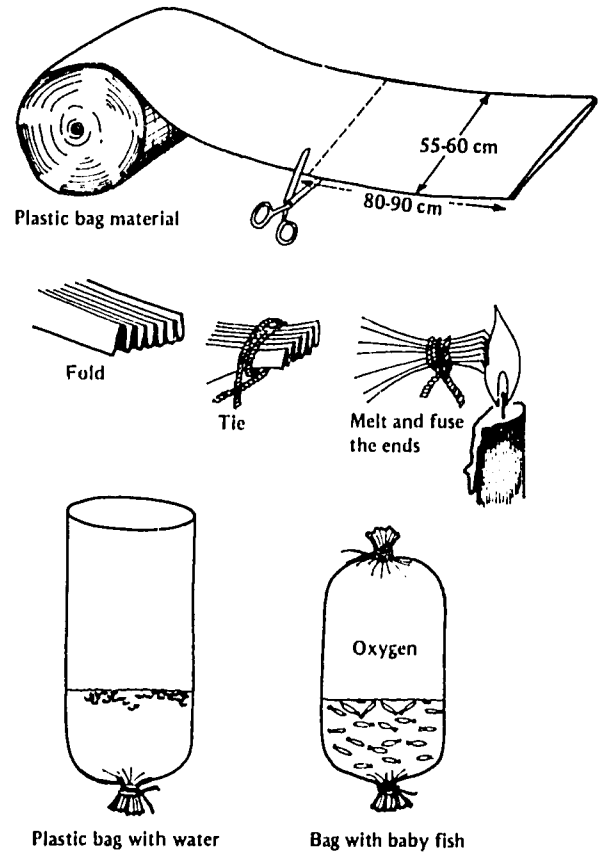

Fig. 6.3

Fig. 6.3. Method of making plastic bags for fish seed transportation. Fig. 6.4. Method of knotting and sealing a plastic bag. Both figures are reproduced from Woynarovich and Horvath (1980).

the bag during transport (Fig. 6.5). The most commonly utilized such containers in India are used kerosene canisters. During transport, it is necessary that the boxes with their plastic bag contents holding live fish be kept in a cool place at a temperature preferably between 20-28°C, since wider fluctuations may discomfort the carp young inside the plastic bag.

Polyethylene or other bags are not suitable for transporting broodfish except in singles or pairs over very short distances. Fingerlings can be transported both in polyethylene bags under oxygen as well as in special closed-system carriers mounted on vehicles described below.

Table 6.2. An estimation of the amount of O_2 required for transport of rohu fingerlings (size range 10.9-12.6 cm and weight range 10.9-19.5 g) and mrigal fingerlings (size range 9.8-10.0 cm and weight range 5.6-8.4 g) at 31-32°C for a period of 1.0-48 hours.^a VO_2 = rate of oxygen consumption.

Temperature °C	Species	Size (cm)	Mean VO_2 /fingerling/hr (O_2 in mg)	VO_2 /50 fingerlings/hr (O_2 in mg)	O_2 required for 50 fingerlings/6 hr		O_2 required for 50 fingerlings/12 hr		O_2 required for 50 fingerlings/24 hr		O_2 required for 50 fingerlings/48 hr	
					(O_2 in mg)	(O_2 in ml)	(O_2 in mg)	(O_2 in ml)	(O_2 in mg)	(O_2 in ml)	(O_2 in mg)	(O_2 in ml)
32	<i>Cirrhinus mrigala</i>	9.8-10.0	1.13	56.5	339.0	137.3	678.0	474.6	1,356.0	949.2	2,712.0	1,898.4
31	<i>Labeo rohita</i>	10.9-12.6	4.0	200.0	1,200.0	940.0	2,400.0	1,880.0	4,800.0	3,360.0	9,600.0	6,720.0

^aFrom Singh (1977). Note the difference in specific oxygen requirements for almost similar size group of two carp species. It is assumed that 1.0 mg of oxygen is equivalent to about 0.7 ml O_2 .

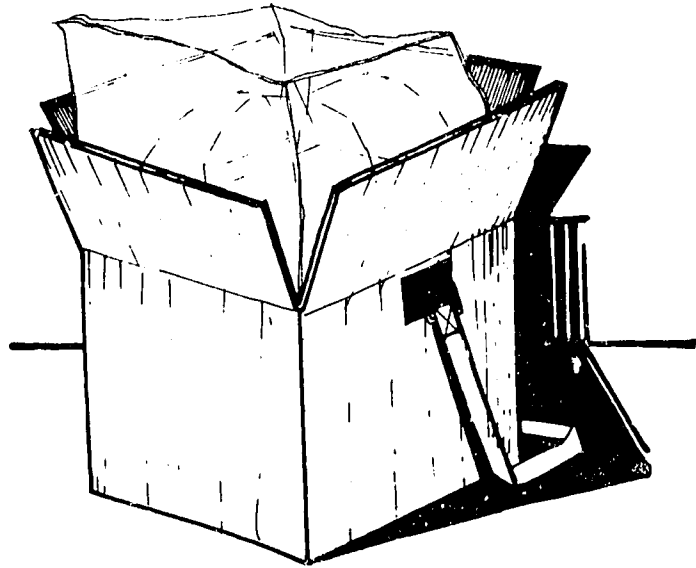

Fig. 6.5. A container for plastic bags holding live fish under oxygen during transport to prevent inadvertent damage to the bags (reproduced from Huet 1972).

TRANSPORT OF FINGERLINGS AND BROODFISH

Broodfish need to be transported in larger containers which can also be used for transporting fingerlings. Two successful models of closed-system live-fish carrier tanks have been designed in India. A recently modified model, originally designed by Mammen (1962) is a petrol tank design of 1,150-liter capacity termed a splashless live-fish carrier. The carrier has an autoclave-type of lid and a built-in aeration system for supplying compressed air, which works on a belt driven by the engine of the transporting vehicle, generally a jeep. An oxygen cylinder is kept on the carrier as a standby for emergency use only. The tank-inside is lined with U-foam³ which prevents physical injury to live fish during transport. A total weight of 250 kg of live fish can be transported at a time in the splashless tank. Adult catla specimens together weighing 60 kg or as many as 90,000 carp fingerlings in the fish to water load ratio of 1 kg per 4.5 liters of water have been successfully transported in such a splashless carrier.

Another live-fish carrier was designed in India by Patro (1968). Patro's carrier is of a laboratory gas supply design and comprises an outer chamber of 120 cm diameter open at the top and a slightly smaller inner one closed at the top, the latter, during transport, fitting inside the former. The top of the inner chamber is provided with an air vent and an oxygen valve. The outer chamber serves as a storage

³U-foam is a kind of plastic used for providing padding or cushioning effect to absorb shock.



Packing Chinese carp fry, Udawalawe, Sri Lanka (photo, R.S.V. Pullin).

tank and is initially filled with water along with fish to be transported. The inner chamber, which is slipped inside from the upper open end of the outer, serves as an oxygen-holding chamber at its top and is lined throughout with U-foam to prevent fish from sustaining injury during transport. The "double barrel" type carrier, as named by Patro, can transport a total weight of 100 kg of live fish at a time. Once filled, the oxygen supply of the carrier lasts up to five hours and thereafter refilling with oxygen becomes necessary.

Special fry transport vehicles (Fig. 6.6) have proved very efficient in Europe and North America. These are furnished with pumping and cooling arrangements to maintain circulation of cooled, oxygen-rich water or have agitators for aerating water in fish-holding containers, lined with styrofoam for insulation. These systems are expensive and are not commonly encountered in South and Southeast Asian countries where their widespread use is also unlikely due to the generally unsatisfactory condition of roads in rural areas and the economic status of fish culturists in developing countries.

The types of live-fish transport units described above and other types should be available pre-fabricated or imported in each country of South and Southeast Asia for use at hatcheries. If, however, such sophisticated live-fish transport units are not available, circular, open canvas bag containers (Fig. 6.7) supported on sturdy metallic frames mounted on motorized delivery vans may be improvised. Portable battery-operated aerators may be used for aeration of such canvas containers. A circular



Fig. 6.6

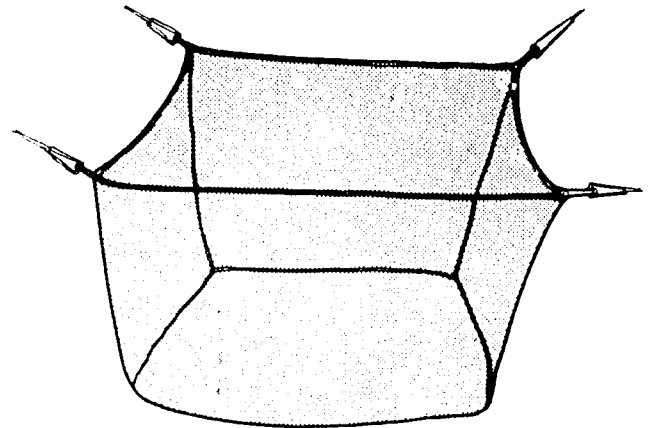

Fig. 6.7

canvas container has the advantages that fish will not injure themselves and the water will keep somewhat cooler due to surface evaporation. One such canvas bag container of 1 m diameter and 1.25 m depth has been used by some of the State Fisheries Departments in India.

Fig. 6.6. A special fry transport vehicle having agitators to maintain oxygen-rich water (photo, R.S.V. Pullin). Fig. 6.7. An open canvas bag (for holding broodfish) for suspension in a water tank to transport live broodfish (reproduced from Huet 1972).

Use of Anesthetic Drugs for Live-Fish Transport

Anesthetizing chemicals have been used in the transporting medium in recent times. The sedation of fish brings about practical benefits by:

1. reducing overall stress on the fish;
2. decreasing the rate of oxygen consumption and reducing the rate of excretion of carbon dioxide and other toxic wastes;
3. controlling the excitability of the fish and thereby reducing chances of physical injury;
4. reducing the time required for handling them.

It is not essential that fingerlings be anesthetized before and during transport but larger fish and broodfish should be anesthetized. The most inexpensive method of tranquilizing them is the use of 5°-10° C water as a transporting medium without a chemical tranquilizer. But this method is unpracticable in tropical or subtropical regions because of difficulty in getting water which is cool and can be kept cool during transport. If cold water as a transporting medium is not available, then chemical tranquilizers should be used before transporting broodfish.

Any of the modes of transport can be used for transporting anesthetized fish. The following drugs are used for anesthetizing common, Chinese and Indian major carps during transport.

Drug	Recommended dose
1. Novacaine	50 mg/kg of fish
2. Amobarbital sodium	85 mg/kg of fish
3. Barbitol sodium	50 mg/kg of fish
4. Sodium amytal	52-172 mg/liter
5. Tertiary amyl alcohol	2 ml/4.5 liters
6. Methyl paraphynol (Dormison)	1-2 ml/4.5 liters
7. Chloral hydrate	3-3.5 g/4.5 liters
8. Urethane	100 mg/liter
9. Thiouracil	10 mg/liter
10. Hydroxy quinaldine	1.0 mg/liter
11. Quinaldine	} see below for dose rates
12. MS 222 (Tricaine methan-sulphonate) ⁴	
13. 2-Phenoxy-ethanol	

Of the above-stated substances the most commonly used tranquilizers nowadays are quinaldine and MS 222. Phenoxy-ethanol is a more recently introduced and far cheaper anesthezing substance than the other two. Quinaldine is a toxic liquid and must be handled with care. Treatment with quinaldine is generally done when fish are held in a large volume of water, such as large concrete tanks. The dilution rate of quinaldine is 1:40,000 (quinaldine to water). The precaution to follow with quinaldine treatment is that its use sometimes leads to irregular movement of fish opercula. When that happens, the fish should be immediately transferred to well-oxygenated water.

The procedure to tranquilize broodfish with MS 222 is as follows. The broodfish are kept in 1:20,000 (MS 222 to water) dilution of MS 222. After 15-20 minutes, when the fish are fully tranquilized, the solution is diluted by adding water. The recommended dilution is 2 times (i.e., 1:40,000) for hardy fish such as common carp and bighead, 2-1/2 times (i.e., 1:50,000) for less hardy fish like grass carp and 5 times (i.e., 1:100,000) for least hardy fish like silver carp among cultivated carps. No dosages of dilution at the secondary stage are known for the Indian major carps.

For long and very long transportation, the water in the container must be oxygenated and care taken to see that the temperature of the medium does not rise higher than 28° C. The ideal temperature of water for transporting live fish in tropics is 20°-24° C.

⁴ From Sandoz, Basel, Switzerland, also obtainable from Aquavet, 2242 Davis Court Hayward CA 94548, U.S.A. and Argent Chemical Laboratories, 14929 N.E. 40th St. Redmont, Washington 98052, U.S.A.

The anesthetic substance, 2-phenoxy-ethanol, is milder than MS 222. Its recommended dose is 30-40 cm³ per 100 liters of water.

One or two small-sized broodfish can be transported in tranquilized condition in a plastic bag under oxygen pressure. Simple hammock-like devices made of canvas can be conveniently used for large broodfish over very short distances, two men holding the hammock poles. Figs. 6.8 and 6.9 show devices for holding and transporting broodfish over short distances.



Fig. 6.8. Cloth bag used for transporting broodfish over short distances (photo, R.S.V. Pullin).



Fig. 6.9. Transporting broodstock for injection (photo, R.S.V. Pullin).

Chapter 7

Applied Genetics of Cultured Carps

General Considerations

Stock improvement through genetics research has been a major factor in increased production of crops and livestock. However, the application of genetics in aquaculture has been largely neglected. Hence, most cultured aquatic animals are less domesticated than terrestrial livestock and many cultured stocks are not far removed from wild types. The common carp and the salmonids are probably the most domesticated of all cultured fish because of their long history of culture, but the Chinese carps and Indian major carps have received very little attention from geneticists and fish breeders wishing to improve the performance of cultured stocks. Most of the information given here refers to the common carp.

Genetic improvement work with fish requires very good facilities for segregating fish stocks from each other and from wild fish, high levels of management and husbandry and rigorous assays for testing culture performance. Most important of all, although fish generally have high fecundity and fast generation times, anyone attempting genetic improvement work should have an adequate knowledge of basic genetics and should appreciate the special problems of working with fish. Genotype-environment interaction is an important complicating feature of fish genetic improvement, more so than with warmblooded terrestrial livestock in which homeostasis is highly developed. It is probably fair to say that most genetic improvement of cultured and ornamental fish achieved so far, with the exception of the work by professional geneticists and breeders on the common carp and ornamental cyprinids, salmonids and catfish has been more by accident than by design. Culturists have pursued sporadic and unplanned programs of individual selection (sometimes also called "mass selection") and hybridization, without understanding the basis of inheritance of the performance traits for which improvement has been sought. Aquaculture management practices can also result in "indirect selection", that is, a change in the genetic characteristics of the stock although not a deliberate change.

Genetic improvement is a very wide term. It means that the new generation performs better than the parental stock. There are several approaches towards this goal: hybridization, selective breeding programs and various additional manipulative techniques. Before considering these, it should not be forgotten that farming practices can produce genetic deterioration as well as improvement. This is particularly true for aquaculture. For example, a hatchery operator who retains some of his own seed production for eventual broodstock replacement should be careful that these are not chosen by force of circumstances, such as a surplus of supply over demand from customers during one period of the spawning season, but rather by deliberate policy to maintain a broad genetic base. Moreover, the use of small numbers of broodstock for species of high fecundity and their replacement by succeeding generations can give rise to inbreeding depression. The literature on inbreeding can be confusing as some authors mention the deliberate production of

inbred lines, which can then be hybridized, as a route towards genetic improvement. However, a high degree of inbreeding is now used only for experimental purposes in domesticated mammals and poultry. For commercial production and stock improvement, inbreeding is best avoided.

All this begs the question, who should take responsibility for developing high performance pedigree stocks of cultured carps? The question is somewhat academic as experimental aquaculture is still a young science. Most fish culturists are innovators and will continue to dabble in stock improvement both for their own farm purposes and to sell "improved stocks" to others (however weak the scientific evidence for the "improvement" may be). This system of individual farmers being responsible for constant improvement of broodstock has been encouraged in some countries. However, it is probably not the best approach for the long-term future of fish culture. Just as livestock, poultry and crop farmers benefit from being able to use pedigree stocks of known characteristics, developed by skilled scientists in specialized breeding centers, so fish culturists should strive towards wider availability of high performance, pedigree fish stocks from accredited centers.

A further special problem is the decision on whether or not to introduce new stocks. This is particularly important when considering introduction of exotic species, but all fish introductions carry the risks of spreading fish parasites and diseases and of disruption of native fish stocks and ecosystems by escapees from farms.

To take a balanced view, as aquaculture concentrates on a few key species/commodities and follows the pattern set by agriculture, it is clear that farmers will need to introduce the best species and stocks available. The dangers inherent in fish transfers are best regarded as necessary evils—the price of progress towards development of aquaculture—and they *can* be minimized by adequate quarantine controls. It is worth noting that the common carp was introduced to every Southeast Asian country during the period 1914-1957. Grass carp, one of the most important species of Chinese carps, has also been spread right across the warm temperate and tropical zones for use in aquaculture and aquatic weed control. Silver carp and bighead are also widely used in polyculture systems. These fish transfers have sometimes been very controversial. All that can be said is that there are not as yet any examples of very adverse environmental impacts of carp introductions in Asia. This may reflect the fact that they have not become widely established in natural waters but remain largely confined to farms. It should be emphasized, however, that *it cannot be predicted with certainty* whether Chinese or Indian major carps will acclimatize sufficiently to breed naturally in natural watercourses and lakes when introduced to a new location.

Approaches to Stock Improvement

Aquaculture is often more capital intensive than labor intensive and the economics of aquaculture often require rapid production to generate returns on investment. This requirement for rapid production from new farms can lead culturists to neglect to give sufficient attention to the genetic characteristics of their stocks. Once a hatchery/farm has been constructed, the temptation is to stock with whichever sources are easiest to acquire. This is a shortsighted and unsound approach, since the pedigree of the farmed stock can be an important determinant of its performance and, therefore, of future profitability of the operation. Of course, poor husbandry with good pedigree stocks will still produce poor results and vice-versa. The aim must be for good husbandry with good pedigree stocks.

The culturist should, therefore, choose his stock(s) with extreme care. For common carp, the type chosen should suit the markets in appearance (scale pattern and shape) and the production needs in performance. For other carps for which stocks of known pedigree and performance are not obtainable, one should use fish with a *broad genetic base* from proven commercial stocks or from the wild. It is particularly important to start with a founder stock of adequate population size, preferably at least 2,000 mixed-sex fry/fingerlings to be grown on to constitute the broodstock. A hatchery's broodstock should be kept up to at least 50 pairs for each species and replacement broodstock should be grown from immature fish (the progeny from a large number of spawnings spanning the entire spawning season, unless a selective breeding program utilizing any genetic determination of spawning periodicity is being followed). Most important of all, the founder stock, whether fry/fingerlings or fully matured broodfish (this can save valuable time but transportation is more difficult and costly), must not be acquired from any source where previous inbreeding is suspected, again unless an inbred or highly selected pure line is sought for a planned program of further inbreeding and/or hybridization. Moreover, all introduced stocks should be from sources which are known to be verifiably disease-free and should be subjected to quarantine procedures.

It is possible that locally available stocks are adequate for a culturist's needs. This is usually the case for species in which little or no genetic improvement of cultured stocks has been attempted, for example, the Indian major carps. However, it is worth summarizing here the options which importation of outside stocks can facilitate:

1. Exclusive use/replacement—when the imported breed is greatly superior to local breeds, the former may be used exclusively, substituting for any local breeds in current use.
2. Upgrading—when the overall performance of the imported breed is higher than that of the local but the latter is superior in some traits such as adaptation to local climatic conditions and/or resistance to local parasites and diseases, hybridization, followed by successive backcrosses to the imported breed may combine the high performance of the imported breed and specific advantages of the local breed.
3. If an F_1 (i.e., first generation) hybrid from a cross between the local and imported breeds is superior to its two parents, the two parents may be maintained as pure lines for production of commercial F_1 hybrid progeny.
4. Even when the imported breed and its F_1 hybrids with the local breed are inferior to the local breed in overall performance or particular traits, the imported breed may provide a broader genetic base for further work, such as backcrossing F_1 hybrids to the local breed with selection for each successive backcross.

The evaluation of an imported breed requires careful consideration. The first broodstock and their progeny may be sensitive to local conditions: climate, diseases or parasites. Therefore, a particular import should undergo at least one or two generations of natural selection under local conditions to judge potential improvement.

Recommendations for sources of fish for founder and/or replacement stocks are given below for the various groups of carps.

HYBRIDIZATION

Hybridization is often a rapid route to genetic improvement. The crossing of distant stocks can produce increased performance termed heterosis or hybrid vigor. The best documented examples of this for warmwater aquaculture are those for the different races of the common carp, *Cyprinus carpio*, particularly crosses

between two major and very distant races of this species—the Chinese “big belly” carps and the domesticated European carps. The former have a history of about 2,000 years of domestication and adaptation to harsh environments. They are disease-resistant, show fast early growth, early sexual maturation with slow growth thereafter, high fecundity and high seine-net escapeability: a mixture of desirable and undesirable traits. The European carps have led a more “sheltered life” and are more domesticated as culturists have pursued strong selection programs for fast growth. They are late-maturing and easily seined but less adapted for harsh environments and more disease-prone.

Crosses between the Israeli mirror carp race “Dor 70” and a Taiwanese “big belly” carp have produced fully scaled hybrids with higher growth rates, lower seine escapeability, and better performance in well-managed culture conditions than the “big belly” race alone. “Dor 70” is a special pure bred race which is not recommended for stocking production ponds but is a very useful parent in hybridization work. The most recent report of the success of this approach is from Hong Kong in 1982 in which hybrids between a local Hong Kong carp race and “Dor 70” grew to an average weight of 815 g in six months in intensive aerated pond culture compared to weight gains of 300 to 400 g for the local race under comparable conditions.

There are many similar examples. Two-, three- and four-line hybrids from a collection of 10 “land races” of Hungarian common carp have produced 30-35% increased fertilization success, 16-21% higher survival, 15-40% growth improvement and 15-30% feed conversion improvement and definite heterosis has been demonstrated in 7 out of 12 F_1 hybrids between various races of Japanese, Chinese and European common carp races.

It must be remembered, however, that such pay-offs from hybridization do not always occur. Attempts to produce heterosis are essentially “shots in the dark”.

SELECTIVE BREEDING PROGRAMS

Most selective breeding programs are designed to pursue improvement of a single desirable trait, e.g., fast growth or disease resistance. Ideally, a breeder should know the relative importance of hereditary and environmental factors in determining the variation in the trait which he sees in his fish (the so-called phenotypic variation). This information is known as the heritability of the trait. If the heritability is high, then the culture performance (phenotypic value) of the fish with respect to the trait in question will be a good indication of their breeding value and, therefore, individual selection programs will be effective in achieving genetic improvement. If, however, heritability is low, then selective breeding programs must be based on more complex systems such as family selection (keeping part or whole broods) and progeny testing to identify genetically superior fish.

Second, for fish, as for other organisms, some of the variance of commercially desirable traits (for which the breeder will try to select) is determined by independent gene activity (so-called additive genetic variance) and some by gene interaction and dominance effects (so-called non-additive genetic factors such as dominant and recessive genes or epistasis—the suppression of one gene by another—for which gene frequencies and generally simple patterns of phenotypic expression are observed). Again, the breeder should know the relative importance of these additive and non-additive genetic factors since it is the additive genetic variance which will determine the success or failure of his attempts at genetic improvement by selection. In most cases, breeders lack such information since reliable determinations of what is called “realized heritability”, i.e., the response to selection, are very scarce. The determination of realized heritability requires studies on at least two generations

of fish. For full definitions of these terms and methods for determining heritability, the reader should consult Falconer (1981).

The best domestication selection programs should incorporate individual selection for additive genetic effects and family selection for dominance and epistatic effects. Designing such programs is difficult. In family selection work, full-sib (brother and sister) families cannot easily be marked (especially young fish) and very extensive pond, tank and aquarium facilities are required.

One approach to building a selection program is to start by considering what is required for an ideal cultured fish. For example, a carp should probably: grow rapidly to at least 1 kg harvestable size; become sexually mature at a late age/large size and have high fecundity for breeding purposes. Other traits could be added to this list, such as disease resistance, high dressing weight, good color and catchability. The point is that these are all valuable commercial traits and that ideally they should not be selected piecemeal but rather ranked, weighed in importance and used to devise a multitrait selection index. Selection could first be initiated on each trait independently in different populations. This would permit the estimation of the realized heritability of each trait and the level of correlated responses between pairs of traits. After this initial phase, the weightings of economic value, the trait correlations and the heritabilities are used to construct a value. Once the index is developed, it becomes a primary basis for evaluation in the selection program. The index is computed for individuals by summing the products of their trait values and the associated weighting coefficients and can be used in family selection by inputting mean values.

There are several advantages in this approach. It can reduce significantly the number of generations required for the development of well-balanced domestic strains. When two commercially valuable traits are negatively correlated, a selection index permits slow progress in both according to their economic weight, whereas a sequential selection program can only improve one of the traits. A selection program permits the regression of early selected traits (loss of benefits) during selection of succeeding traits while a multitrait selection index produces simultaneous selection of all the included traits. Again the construction of a multitrait selection index is explained in Falconer (1981).

What gains can be expected from selection? Unfortunately, data on the heritability of growth traits in fish are very limited. For salmonids, most values of estimated heritability¹ for growth traits are in the range 10 to 35% (with standard errors ranging from ± 10 to 20%). This is moderate to high heritability by comparison with other livestock. Although the information available is somewhat confusing and heavily biased towards cold water species, the evidence is that the realized responses to selection have been beneficial. An improvement of 0.2 g (about 6%) per year has been reported over three generations in a selection program for 17-day post-fertilization weight in rainbow trout. This compares well with results achieved with domesticated livestock.

Additional Techniques

There is a growing body of literature on chromosome manipulation in fishes. The most important techniques for further investigation are probably:

GYNOGENESIS

In gynogenesis, there is no fusion of chromatic material between the ovum and the spermatozoon. The latter merely activates the ovum at fertilization. The usual

¹Estimated heritability values are higher than realized heritabilities (the real response to selection). For full details, see Falconer (1981).

method is to irradiate spermatozoa, mix with cva and then cold-shock the ova. This technique allows the rapid production of homozygous fish and is the ultimate in inbreeding techniques. However, unless very large heterotic effects can be obtained from crossing gynogenetic lines, this, like other inbreeding, is not advisable for commercial practice.

POLYPLOIDY

Cold-shocking has also been used with varying degrees of success to produce polyploid eggs often in association with the use of irradiated spermatozoa as mentioned above. The possible advantages of polyploidy include improved growth performance and the production of sterile progeny thus avoiding the channelling of nutrients into gonad production before marketing. However, studies have been very limited (mainly on salmonids and pleuronectids) and the occurrence of natural polyploids for comparison has not been fully investigated. The advantages of polyploidy for aquaculture have yet to be proved.

SEX INVERSION

Sex inversion by administration of exogenous steroid hormones has been the subject of much research in fish breeding, particularly for the tilapias in which male fish have a significantly higher growth rate than females. Administration is normally by incorporation of methyltestosterone in feeds. The production of monosex or sterile progeny of grass carp (*Ctenopharyngodon idella*) has also attracted some interest as a means of eliminating reproduction of exotic stocks introduced for weed control and their possible uncontrolled spread and undesirable environmental consequences. However, there is no evidence at present that sex inversion techniques confer any advantages in hatchery procedures for cultured carps. This situation may change as new data are obtained, particularly the use of anabolic steroids for growth promotion in addition to sex inversion.

IRRADIATION TECHNIQUES

The effects of irradiation on fish gonads and pituitary gland have received some attention from researchers but nothing has emerged from this work for application by fish culturists as yet.

Common Carp Genetics

The common carp is probably the world's most domesticated fish. Its natural habitats are the rivers and lakes of eastern Europe and the mainland of Asia. Its various geographical races have been assigned to different subspecies, as described in Chapter 1. However, the taxonomy of wild carp is not a matter of concern here except to remember that they exist as genetic resources for future experimentation. The most important point to note is that domestication of the common carp for culture has followed two different paths to produce the European domesticated carps and the Chinese "big belly" carps. Within this main framework of domestication, a large number of so-called races, strains and varieties have been developed. The four main varieties are recognized by their scale patterns: the scale carp, which is scaly all over like the wild types; the mirror carp, with a reduced number of enlarged scales dorsally and on the flanks; the line carp, with one row of scales along the lateral line and the leather carp, which is virtually scaleless. Fig. 7.1 to 7.4 show some examples of different types of common carp.

In general, strains of the scale-reduced varieties, particularly mirror carp, are preferred in Europe, whereas scaled fish are preferred in Asia, but breeders in both continents use stocks of both varieties according to local conditions. Rather than



Fig. 7.1



Fig. 7.2

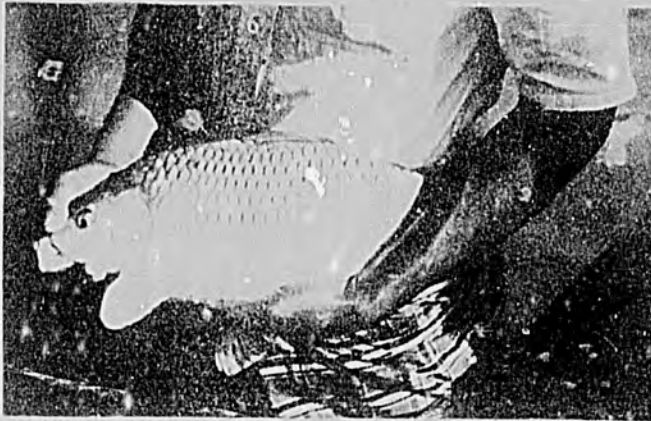

Fig. 7.3

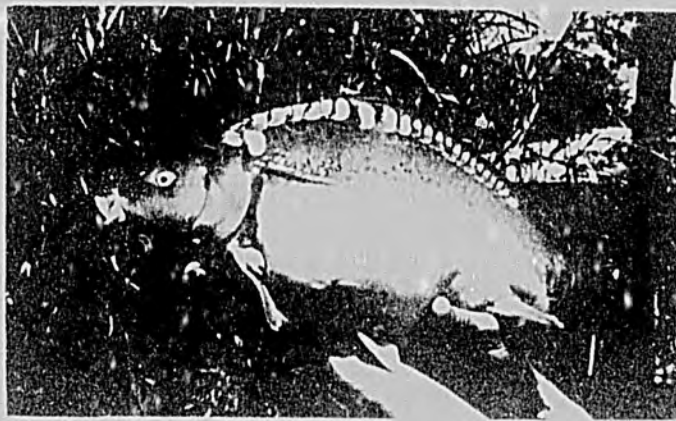

Fig. 7.4

Fig. 7.1. Scale carp: an Asian "wild" race termed "local strain" in South Sumatra, Indonesia. Fig. 7.2. Scale carp: Chinese big belly carp in Burma. Fig. 7.3. Scale carp: Majalayan strain broodfish at Sukabumi, West Java, Indonesia. Fig. 7.4. Mirror carp: Dinnyes strain Hungarian carp at Baluhar Baor, Jessore, Bangladesh. All photos, R.S.V. Pullin.

attempt to assign scientific names to all these types, it is best for culturists to call them all common carp, *Cyprinus carpio* but to always specify the origin and history of a given stock. There is unfortunately no agreed convention on nomenclature for cultured races, strains and varieties and fish normally bear the name of the location, region or hatchery in which the strain was developed. It must be emphasized that most so-called strains have yet to be subjected to thorough genetic investigation, for example, by electrophoretic methods. This is particularly true for tropical situations. Therefore, claims for the performance of strains must be interpreted with caution.

In Europe, particularly in the Federal Republic of Germany, the diversity of the strains of carp available reflects the long history of carp culture. Since the beginning of this century, studies have been made on these strains. Numerous strains are

now maintained in broodstock collections. Information on some of the more famous strains is summarized in Table 7.1. The Galician mirror carp has been particularly successful and is now used in a number of countries, principally Germany and Poland. It does particularly well in a continental climate (very cold winters/very hot summers) and in areas with poor sandy soils. The Aischgrunder mirror carp race (which is said to be over 300 years old) is better suited to well-managed, well-fertilized ponds with a clay type of soil and to a mild climate with warm summers. Most

Table 7.1. Summary information on some strains of the common carp (*Cyprinus carpio*) in Europe.

Name	Main location(s)	Appearance	Other comments
Aischgrunder	Aischgrund, Bavaria, FRG	Mirror carp; height: length, about 1:2; gold yellow color with other variations such as blue color or complete lack of silvery shine; fins often reddish due to strong peripheral blood vascularization.	A good carp for culture in temperate conditions in fertile ponds.
Bohemian	Bohemia, FRG	Leather carp; height: length, about 1:3; brown color.	Slow growing; derives from cold mountainous terrain with acidic ponds and volcanic soils.
Dinnyes (see Fig. 7.4)	Hungary	Mirror carp; greyish back with golden sides.	A hybrid developed in Hungary which has been introduced to Bangladesh and performs well.
Galician	Galicia, FRG	Mirror carp; height: length, about 1:1.25; light flesh color (original strain).	A good carp for culture in poor sandy soils and climates with extreme seasonality.
Lausitzer	Lausitzer, FRG	Scale carp; height: length, about 1:2.7.	From mountain habitats like the Bohemian carp.
Wild	Throughout Europe	Scale carps of variable color with long, narrow bodies.	Perform poorly in culture but important as genetic resources (Bardach et al. 1972).

of the work on these and other carp races in Germany has been concentrated on the appearance of the carp, particularly the height/length ratio. Generally speaking, a deep-bodied, fast-growing fish is preferred, like the Galician mirror carp.

Many hybrid crosses between strains have been performed in Europe. For example, many of the carps cultured in Hungary and Yugoslavia are derived from Aischgrunder x Galician crosses and Hungarian, Aischgrunder, Bohemian and Lausitzer carps have been hybridized into the "Militsch" carps. The result is a wide diversity of high performance strains and hybrids across Europe, such as the Dinnyés carp (Fig. 7.4): a mixture of Hungarian, Israeli and Yugoslavian stocks. In the USSR, a number of other carps have been developed for colder conditions and short growing seasons.

In Asia, the information on common carp genetic resources is more limited. Table 7.2 gives some summary information, but until more data are available on Chinese work and on the full characterization of the Indonesian strains, little more can be said. Among the Asian strains examined by the authors, the Majalayan strain from West Java was very impressive and would perhaps be a good candidate for further genetic selection and wider use in tropical carp culture.

Name	Main locations	Appearance	Other comments
Asagi	Nagana Prefecture, Japan	Scale carp; deeper-bodied than wild carp; back and sides colored light blue.	Limited use in culture (Suzuki and Yamaguchi 1980).
Big Belly	China, Hong Kong, Taiwan	Scale carp; deep-bodied.	A collective name for cultured Chinese stocks.
Majaiayan (see Fig. 7.2)	West Java, Indonesia	Scale carp; greyish color.	Fast-growing, widely cultured in Indonesia.
Punten	West Java, Indonesia	Scale carp; olive green.	
Sinyonya	West Java, Indonesia	Scale carp; yellow.	
Wild (see Fig. 7.1)	Central/East Asia	Scale carp; variable color; long, narrow-bodied.	Perform poorly in culture, but important as genetic resources (Bardach et al. 1972).

A complete catalogue of strains and hybrids is beyond the scope of this manual, and expert advice should be sought when planning new introductions. Asian hatchery operators should note, however, that a wide diversity of common carp genetic resources does exist and that some European strains may adapt well to Asian conditions. For example, in Japan, introduced German mirror carps have out-performed the local Yamato strain for fast growth.

There is little doubt that the long history of domestication and selective breeding of common carp has reduced the scope for future genetic improvement in some stocks. For example, there is strong evidence that the domesticated European mirror carps have reached a selection plateau for fast growth (although commercial stocks still maintain a large genetic variance). This means that continued individual or family selection within stocks for fast growth is unlikely to yield significant benefits. The growth rate of such carps is depressed by even a single generation of sib-mating, whereas crossbred carp often exhibit heterosis for growth rate and disease resistance.

Domesticated carp generally have deeper bodies, longer intestines and more gill rakers than wild carp. Mirror carp and scale carp are usually superior to line and leather carps in growth performance and survival. However, it is dangerous to generalize since environmental factors can greatly modify the appearance (particularly body shape) and growth performance of cultured carps. Genotype-environment interaction is, therefore, a very important consideration in common carp culture. The Chinese and European races respond differently to different environments. Chinese common carp are also regarded as faster-growing than European carp during the juvenile phase but slower thereafter.

With regard to manipulative techniques, mass production of gynogenetic carp ova has been developed in Hungary and is being used as an experimental tool in crossbreeding programs using highly inbred strains, with sex inversion to produce the required males. Triploid common carp have also been produced but data on their growth performance are incomplete: their juvenile growth performance does not differ from that of diploids, but the picture may be different in later life as the triploids should be sterile.

Genetics of the Chinese Carps

The Chinese carps have a long history of culture in mainland China and were brought to Taiwan three to four centuries ago. They have not, however, been domesticated to the same extent as the common carp because all culturists relied on seed collected from the wild or artificially fertilized from handstripped wild fish up to the 1930s, when induced spawning (hypophysation) techniques became available.

Crossbreeding between different species and genera of the Chinese carps has been performed by several researchers and many of the hybrids are viable. However, for most crosses involving silver carp, bighead carp, grass carp, black carp and common carp, information is very limited and there are no data comparing commercial traits between hybrids and parents which suggest that culturists should adopt any particular hybrid cross.

Genetics of the Indian Major Carps

Information on the genetics of the Indian major carps is very limited as most culturists collect new broodstock at frequent intervals (often annually) and domestication of these species has scarcely begun. There are no distinct races or varieties of catla, rohu or mrigal although the meristic counts of moat and river stocks of mrigal may differ significantly. For a full account of the geographical distribution and characteristics of these species, the reader should consult the relevant synopses of data published by FAO. A golden form of catla has been reported—a phenomenon which is widespread in the carp family. There have been many hybridization trials with Indian major carps. Most hybrids are viable, but no improvements have emerged of value to culturists. The most significant results have been that hybrids between rohu and kalbasu (*Labeo calbasu*) appear to be superior in growth rate to kalbasu, irrespective of the direction of the cross. Also some work with a rohu x catla hybrid suggests that the combination of quick growth (catla) with small head (rohu) is desirable. Hybrids between Indian major carps and Chinese and common carps are generally nonviable. See also Chapter 1 for further information.

Summary of Recommendations for Hatchery Operators

1. For choosing your stock(s)—make a thorough appraisal of the characteristics and performance which your operation requires and ideally choose a disease-free, proven commercial stock with desirable traits such as fast growth, good body conformation, disease resistance, high fecundity, good flavor, etc., to suit you and your customers.
2. If introducing a stock, make sure that you purchase at least 2,000 fry/fingerlings for growout to become broodstock and maintain a broodstock of 50 to 1,000 breeding sets of each species.
3. Quarantine all introductions (see Chapter 9).
4. Do not attempt genetic improvement work by hybridization and/or selective breeding without a thorough analysis of your objectives, a detailed plan of the procedures involved and the facilities required. Most important of all, make sure you have adequate facilities to keep stocks separate from each other, in sufficient numbers to avoid inbreeding and the means, either on your farm or through cooperation with other farmers, to undertake a sustained program of evaluation of stock performance. Attempts at stock improvement without thorough evaluation are a waste of time and can lead to erroneous conclusions.
5. Always seek professional advice if in doubt. Remember that the genetic characteristics of the stocks you choose can be a major determinant of their performance and of the fish grown by all your customers.

Chapter 8

The Nutrition of Cultured Carps

Introduction

There is a large body of literature on the nutrition of cultured carps, most of which concerns the common carp (*Cyprinus carpio*). Moreover, information on larval, fry and fingerling nutrition is very limited: most reports deal with larger fish. This is unfortunate because it is well known that the nutritional requirements and feeding behavior of fish usually differ markedly between early life history and adult stages.

For carp culture in tropical developing countries, the feeding regimen is usually based on both natural and supplemental feeds. In other words, a nutritionally complete pellet, such as would be needed for high density, intensive culture in cages or tanks, is not usually required. In considering the application of nutritional data to carp culture, therefore, it is very important to recognize the difference between complete and supplemental feed formulation.

The common carp, in particular, has prospered as a cultured fish because of its omnivorous bottom foraging feeding habit and its good growth in fertilized ponds and on cheap feeds which are truly supplemental to natural feeding. Chapter 1 gives the feeding habits of adult cultured carps. The formulation of complete feeds for intensive culture is more difficult than that for supplemental feeds. Complete feeds usually contain generous amounts of high quality protein, such as fishmeal, and are, therefore, expensive (see Table 8.1).

A very important consideration in carp nutrition is the activity of intestinal bacteria which assist digestion and can provide nutrients supplemental to the ingested material. Their role has not been fully investigated. This is a complicating factor in working out the dietary requirements of carps. However, sufficient data for the common carp now exist to have a broad picture of its protein, amino acid, lipid (including essential fatty acids), carbohydrate, mineral, vitamin and trace element requirements (Jauncey 1982).

All the species mentioned in Chapter 1, including the specialist plankton feeders, will accept supplemental feeds. However, since data for the formulation of such feeds are confusing and also to some extent location-specific according to the natural feeding available, they will not be considered in detail here. Most supplemental feeds are made up by experience on an empirical basis. For example, the supplemental broodfish feed recommended for all carps in fertilized ponds at the Raipur hatchery, Bangladesh consists of 3-5% body weight daily of a wheat bran, oil-cake, coarse wheat flour, fish meal mix in the ratio 4:4:1:1. Even complete feeds are sometimes formulated on an empirical basis. For example, in cage culture trials with grass carp, a 50:50 commercial trout pellet: wheat flour mixture has been used successfully as a complete feed for all growout stages from < 10 g to 250-300 g. The composition of the feed was about 34% protein, 48% carbohydrate, 7% fat, 2%

Table 8.1. Composition of a 40% protein carp grower diet (NRC 1977).

Ingredient	International feed no. ^a	Amount in diet (%)
Fish meal (mechanically extracted, 65% protein) ^b	5-01-982	46
Wheat middlings, less than 9.5% fiber	4-05-205	23
Rice bran with germ (solvent extracted meal)	4-03-930	7
Wheat bran	4-05-190	5
Soybean seeds (solvent extracted meal, 44% protein) ^b	5-20-637	5
Torula yeast (dehydrated)	7-05-534	4
Corn gluten meal	5-02-900	1.5
Vitamin premix ^c	—	0.5
Mineral premix ^d	—	0.5
Sodium chloride	—	0.5
Potassium phosphate	—	2.0

^aEach feedstuff has a six-digit international number. The first digit gives the class of the feed. The systems for numbering are fully described in NRC (1977, 1983).

^b6.25 x percent nitrogen.

^cVitamin premix: vitamins added to cellulose powder to make 0.5% of diet (mg/kg):

Choline chloride	500	Riboflavin	25
Ascorbic acid	80	Pyridoxine	8
Inositol	80	Thiamine hydrochloride	5
Niacin	60	Biotin	0.05
Calcium pantothenate	80	Vitamin A	8,000 (IU/kg)
Vitamin E	45	Vitamin D3	1,500 (IU/kg)

^dMineral premix added to cellulose powder to make 0.5% of the diet (mg/kg):

Manganese	25	Magnesium	250
Iron	10	Cobalt	3
Zinc	25		

fiber and 10% ash on a dry weight basis with a total energy content of about 4.4 kcal/g dry matter.

A complete guide to feed ingredients for warmwater fishes is provided by NRC (1977, 1983). For advice on the principles of supplemental feed and formulations, readers should also consult a guidebook prepared for tilapia culture which contains very useful summaries of feeding principles and practices (Jauncey and Ross 1982). This information, some of which is given below, can be applied in carp culture after reference to data on carp nutritional requirements.

Feed ingredients, particularly proteins and carbohydrates, must be digestible as well as sufficient in chemical composition. Table 8.2 shows that common carp are well able to digest plant proteins and most fish can digest animal and microbial proteins and a wide range of carbohydrates. However, the utilization by fish of plant cell wall material (celluloses and other structural materials collectively termed fiber) is largely a matter for conjecture. In the tilapias, it has been shown conclusively that blue-green algal cell wall digestion (and probably also, therefore, the utilization of

Table 8.2. Plant protein digestibility as percentages by ruminants, swine, rabbits and common carp (reproduced from NRC 1977; original source, Nehrin 1965).

Plant protein source	International feed no.	Ruminants	Swine	Rabbits	Common carp
Wheat, grain	4-05-211	91	—	—	83
Barley, grain	4-00-549	77	70	33	64
Rye, grain	4-04-047	83	—	—	63
Oat, grain	4-03-309	83	49	64	64
Corn, gent yellow, grain	4-02-935	80	70	25	66
Peas, seeds	5-04-597	80	80	64	79
Soybean, seeds, heat processed	5-04-597	80	80	74	81
Lupine, sweet yellow, seeds	5-08-453	92	90	—	85

detrital bacterial proteins) is highly dependent on a cycle of very strong acid secretion, stimulated by stomach filling. For stomachless carps, this mechanism cannot operate. There is an open field for further research here. In general, carp use dietary protein and lipids for energy in preference to carbohydrate (but see discussion below).

The Nutritional Requirements of Adult Common Carp and Other Cultured Carps

GENERAL CONSIDERATIONS

First, it must be emphasized again that the data available on the common carp greatly exceed those available for all other cultured carps. The common carp is best regarded as a benthic omnivore. It has no stomach and, like other carps, tends to feed for long periods of time. Therefore, in intensive carp culture, fish are usually fed small amounts of feed at frequent intervals. For example, the best feed conversion for 40 g carp at 23°C is obtained from giving a total of 2.2% body weight per day dry, complete pelleted diet as nine equal feedings. The best growth, however, is obtained using the same frequency at 6.5% body weight per day. The known optimum growth temperature ranges for carps are: common carp, 23-30°C; silver carp, 30-31°C; grass carp, 22-25°C. The Indian major carps prefer high temperatures, close to 30°C. Most experimental studies on the common and Chinese carps have been made towards the lower end of this range, and it should be remembered that feeding habits, feed conversion and nutritional requirements (particularly energy substrates) will be different at higher, tropical temperatures. Food passage through the fish gut quickens with temperature and can double in speed for a 10°C rise. For grass carp, food passes through the gut in about eight hours at 30°C. Metabolic rate and growth are also faster at warmer temperatures and thus, energy substrates in the diet and protein for tissue synthesis are required in larger quantities. There is obviously a need for further study on the nutritional requirement of carps at tropical temperatures. At temperatures below the optimum ranges, growth falls off rapidly. For example, silver carp and grass carp grow poorly below 20°C, show very poor appetite at 10-15°C and stop feeding entirely below 9-10°C.

The second consideration is on protein requirements including essential amino acids. Most experimental studies have shown that carp grow best on high protein

diets. For example, dietary protein levels of 28 to 35%, with metabolizable energy¹ content around 3.4 to 3.8 kcal/g, have been recommended for adults and brood-stock. This may seem surprising for a benthic foraging fish, but it is not really so. A similar situation exists for the tilapias in which protein levels of around 40% are recommended for intensive culture. This merely indicates that the feeds consumed by microphagous/detritivorous fish are exceedingly rich in proteins from various sources—bacteria, microalgae, meiofauna and small invertebrates.

Carp, like other fish species so far investigated, require ten essential amino acids: arginine, histidine, isoleucine, leucine, lysine, methionine, phenylalanine, threonine, tryptophan and valine (Table 8.3). Deficiencies in one or more of these can cause growth depression and possibly deficiency syndromes which look like disease conditions, for example, skeletal deformities. The proteins taken in by carps must, therefore, be sufficiently digestible and also supply sufficient amounts of all these compounds. Although carp intestinal bacteria can synthesize both essential and non-essential amino acids to some extent, this should not be relied on in formulating complete diets.

Basically, the data in Table 8.3 indicate that common carp has similar quantitative essential amino acid requirements to other cultured fishes, such as trout, salmon and eels. For example, the requirements of trout for the amino acids lysine and methionine (the two most likely to be limiting in processed feed components) are 2.12(5.3/40) and 0.72 (1.8/40) using the same notation as in Table 8.3. This leads to the conclusion that the common carp requires not only high protein diets but also high quality animal or bacterial protein for optimum growth. Plant proteins alone are not sufficient. For example, soybean protein concentrate given at 30% level as

Table 8.3. The essential amino acid requirements of common carp (*Cyprinus carpio*), summarized from Jauncey (1982). Values are expressed as g/100 g of dry diet. In parentheses, the numerators are g/100 g of protein and the denominators are percentage total protein. I - data from Nose (1978); II - data from Ogino (1980).

Amino acid	I	II
Arginine	1.6 (4.3/38.5)	1.52 (3.8/40)
Histidine	0.8 (2.1/38.5)	0.56 (1.4/40)
Isoleucine	0.9 (2.5/38.5)	0.92 (2.3/40)
Leucine	1.3 (3.3/38.5)	1.64 (4.1/40)
Lysine	2.2 (5.7/38.5)	2.12 (5.3/40)
Methionine ^a	1.2 (3.1/38.5)	0.64 (1.6/50)
	Cystine = 0%	Cystine = +
	0.8 (2.1/38.5)	
	Cystine = 2%	
Phenylalanine ^a	2.5 (6.5/38.5)	1.16 (2.9/40)
	Tyrosine = 0%	Tyrosine = +
	1.3 (3.4/38.5)	
	Tyrosine = 1%	
Threonine	1.5 (3.9/38.5)	1.32 (3.3/40)
Tryptophan	0.3 (0.8/38.5)	0.24 (0.6/40)
Valine	1.4 (3.6/38.5)	1.16 (2.9/40)
Total	13.7 (35.8)	11.28 (28.2)

^aNote that methionine requirements vary with the level of cystine present in the diet and phenylalanine requirements with tyrosine.

¹See NRC (1977, 1983) for definitions and explanations of units.

the sole protein source gives a methionine-deficient diet. A good summary on warmwater cultured fish nutritional requirements and extensive tables on the digestibility and composition of feed ingredients (including protein amino acid profiles) are given in the reviews by NRC (1977, 1983).

Fortunately, the protein requirements of carp can be modified by raising the levels of other dietary components. This is called sparing the dietary protein component. The most important sparing compounds for common carp are lipids. These supply energy which would otherwise be used by metabolizing proteins and amino acids. For example, the optimum protein of young mirror carp feed in Hong Kong was reduced from 38 to 33% by adding 5% soybean oil. The addition increased the dietary metabolizable energy from 2.8 to 3.1 kcal/g. Moreover, as common carp are generally accepted to be fatty fish, with carcass lipid levels as high as 20% from pond culture, there is great scope for increasing dietary lipid content even if this results in some elevation of tissue lipid levels. Levels as high as 18% can be used with no growth retardation, no unacceptable carcass lipid buildup and improved protein utilization.

The data on sparing dietary protein in carp by other compounds are confusing. Attempts to use nonprotein nitrogen compounds such as ammonium citrate and urea have not produced any clear results for application by culturists. The other obvious energy source for sparing dietary protein is carbohydrate. Carbohydrate requirements are discussed below. Attempts to raise dietary carbohydrate levels to spare protein have met with mixed results. Recent results, however, suggest that dietary energy as carbohydrate can be used by mirror carp; for example, fingerlings grow very well on a 45% rice feed and protein digestibility is improved (see below). The relationships between dietary protein and energy levels and their effects upon carcass composition are complex. For further recent experimental results, the reader should consult Zeitler et al. (1984).

LIPID REQUIREMENTS

Lipids are required for energy (see above) and for building tissues. The most important class of lipids to consider for fish feed formulation is the polyunsaturated fatty acids (PUFA). Fish have dietary requirements for certain essential PUFA which must be present in the diet to ensure normal growth and lipid metabolism. PUFA form large series of chemical compounds, described by a notation involving the Greek letter ω . For example, the most essential PUFA for fish are those of the ω 3 series such as linolenic acid which is written as 18:3 ω 3. The first number gives the number of carbon atoms; the second, the number of double bonds and the last number, prefixed by ω , the position of the first double bond numbered from the methyl end. Fish also have requirements for ω 6 series PUFA. The detailed chemistry of these compounds need not concern carp culturists. It is sufficient to remember that certain of them are *essential* and that the best sources for feed formulation are fish oils, including liver oils.

For carps, diets which are deficient in essential PUFA could give rise to symptoms like fatty livers and unacceptably fatty carcasses, particularly if large amounts of carbohydrate are ingested. The dietary requirement of linolenic acid for common carp is about 1%. All the cultured carps can probably derive their essential dietary lipid requirements from natural feeding since these compounds are present to varying extents in microalgae, meiofauna and other biota. However, if deficiency is suspected, fish oils should be included in complete and supplemental feeds. Feeds which contain high levels of fish meal may usually omit fish oils (e.g., Table 8.1).

CARBOHYDRATE REQUIREMENTS

For most animals, carbohydrates are the principal dietary components used for energy. For carps, however, the literature on carbohydrate utilization is very confusing. There are very few definitive studies. For common carp, questions such as whether cellulases can be produced in sufficient quantities by intestinal bacteria to enable significant digestion of plant cellulose remain unresolved. Most of the available information suggests that amino acids and lipids are better energy sources for common carp than carbohydrates. However, recent work with fingerlings (see below) suggests that high carbohydrate diets are well worth trying. The best approach is an empirical one, incorporating locally available carbohydrates such as broken rice, cassava and other flours and starches in feeds. The most likely symptom of oversupply of carbohydrates in carp diets is excessive deposition of fat in the liver, heart and carcass. Recently, Viola and Arieli (1983) have shown that Israeli carp (Dor 80 race) will thrive on pelleted feeds containing 65-75% cereal grains (yellow dent corn, sorghum and hard wheat) in a 25% crude protein pellet. Wheat bran was also tried in a 1:1 mixture with corn. The general conclusions of this work were that for incorporation of grains into common carp feeds, corn and sorghum are useful ingredients and are interchangeable according to prices. Bran can also be included in a feed with these grains up to 20%. Wheat is usually expensive and should be included only as a pellet strengthener. Barley, even when cheaper than other grains, should not be used, since it gives poor results.

VITAMIN REQUIREMENTS

Recommended dietary vitamin levels and daily intakes for common carp are given in Table 8.4. The requirements of the other carps are probably similar. For example, ascorbic acid, cyanocobalamin (vitamin B₁₂), folic acid, inositol and thiamine have been shown to be essential dietary vitamins for the mrigal (*Cirrhinus mrigala*). A wide variety of vitamin deficiency symptoms (avitaminoses) have been

Table 8.4. Vitamin requirements of the common carp; modified from Jauncey's 1982 data table from many sources. A blank entry means that definitive data are lacking, but all vitamins listed here are assumed to be essential.

Vitamin	Suggested dietary level	Recommended intake (mg/kg/day)	Vitamin	Suggested dietary level	Recommended intake (mg/kg/day)
Thiamine (B ₁)	60 ppm	--	Choline	2,000-4,000 ppm	60-120
Riboflavin (B ₂)	40-62 ppm 70-100 ppm	0.11-0.17 0.23-0.33	Niacin	28 ppm	0.55
Pyridoxine (B ₆)	20 ppm	0.15-0.20	Cyanocobalamin (B ₁₂)	0.09 ppm	--
Pantothenic acid	30-40 ppm	1.0-1.4	Vitamin	2,000 i.u./kg.	4,000-2,000 i.u./kg/day
Inositol	440 ppm	7-10	α-tocopherol (E)	100 ppm 300 ppm	-- --
Biotin	10 ppm	0.02-0.03	Ascorbic acid (C)	2,000 ppm	--
Folic acid	15 ppm	--	Menadione (K)	40 ppm	--
Para-amino-benzoic acid	15 ppm	--			

described including loss of appetite, poor growth, disorientation, exophthalmia (bulging eyes), color changes and specific tissue conditions such as hemorrhaging lesions and skeletal deformities. For carps cultured in ponds and having access to natural feeding, avitaminoses are very unlikely to occur. Thus, a complete list of symptoms for specific avitaminoses is not included here. Such a list could cause confusion since many of the symptoms are more likely to result from other causes such as stress and disease factors and other nutritional deficiencies in most carp

culture operations. As can be seen from Tables 8.1 and 8.4, it is a simple matter to include a vitamin premix in carp feeds as an insurance that all vitamin requirements are taken care of. This is standard practice in formulation of poultry feeds.

Certain of the vitamins listed here and included in premixes may not be absolutely essential for carps. For example, it has been found recently that gut bacteria in tilapias can synthesize vitamin B₁₂ and the same situation may apply to carps. However, such points are mainly of academic interest. The vitamin requirements of carps are best supplied with a complete vitamin premix.

MINERAL AND TRACE ELEMENT REQUIREMENTS

Fish obtain some of their mineral and trace element requirements from ingested food and associated material like detritus and some from the water in which they live. Carps require the same dietary minerals (calcium, iron, magnesium and phosphorus) and the same trace elements (cobalt, iodine and zinc and probably also copper, fluorine, manganese, molybdenum and sulphur), as in higher vertebrates. Table 8.5 summarizes the available data for common carp. The other carps probably have similar requirements. The rohu (*Labeo rohita*) requires 0.014% dry diet of iron.

Table 8.5. Summary of available data on the mineral and trace element requirements of the common carp (data from various sources, reviewed by Jauncey 1982).

Mineral/trace element	Dietary requirement (% dry diet)
Calcium	depends on available phosphorus; grows well on as little as 0.03% if sufficient phosphorus is present and water contains 16-20 ppm calcium
Phosphorus	0.6 to 0.7%
Magnesium	0.04 to 0.05%; deficiency can be aggravated by high calcium diets
Zinc	0.0015 to 0.0030%

Table 8.6. Availability of dietary phosphorus in various feed ingredients for common carp and rainbow trout.^a

Ingredient	% Phosphorous content	% Availability of phosphorous	
		Carp	Trout
Tribasic calcium phosphate	0.65	3	51
Monobasic calcium phosphate	0.79	80	65
Phytin	1.65	8	19
Casein	0.47	100	90
Fishmeal	0.99	26	60
Hydrocarbon yeast	0.46	99	91
Wheat germ	0.53	57	58
Activated sludge	0.84	12	49
Rice bran	0.79	25	19

^aAfter Jauncey (1982).

Carps appear to be less sensitive to mineral-deficient diets than other fish. In pond fish culture, natural feeding on plankton and benthos can probably supply their dietary mineral requirements but, as in the case of vitamins, the inclusion of a mineral premix in supplemental and complete feeds is advisable to make sure.

The two elements most likely to cause serious deficiency symptoms in carps are calcium and phosphorus, since these are required for bone and other tissue synthesis. Most commercial feeds contain sufficient calcium and phosphorus for carps in their fishmeal components. Moreover, carp can utilize calcium from water, if present at 16-20 ppm, to make good dietary deficiencies. However, phosphorus is present only in very low concentrations in most freshwaters and with supplemental feeds, in which fishmeal has been replaced by plant or other protein sources, deficiencies can arise. Carp fed on complete diets low in available phosphorus show increased lipid levels in the viscera. Much of the total phosphorus in cereals is chemically bound to phytic acid. Fish cannot use phytin-bound phosphorus since they lack the digestive enzyme phytase. Japanese work has shown that the best growth of common carp is obtained on feeds containing 0.6 to 0.7% available phosphorus. Deficient diets can be made good by adding 5% monobasic calcium phosphate to the feed mix, but for

cheap, supplemental feeds based on locally available materials, culturists need only be sure that (1) the total feed mix contains sufficient phosphorus and (2) that the phosphorus is available. Note that the availability of phosphorus to common carp is not the same as for fish which have a stomach and acidic digestive system (see Table 8.6).

Hepher and Sandbank (1984) have shown that phosphorus supplementation in common carp feeds can result in increased growth in some circumstances. For example, 1% di-calcium phosphate supplementation is recommended for large fish in polyculture systems where the standing crop of common carp is high (> 1.8 ton/ha) and phosphorus from natural feeding may be inadequate.

The Feeding Habits and Nutritional Requirements of Carp Postlarvae, Fry and Fingerlings

GENERAL CONSIDERATIONS

Very little detailed work has been done on the feeding habits of carp postlarvae, fry and fingerlings. However, it is known that common Chinese and Indian major carp *all* require a microzooplankton diet initially, feed on progressively larger items as they grow in size and make a gradual transition to the appropriate adult feeding habit as fingerlings (see Table 8.7 for examples). The grass carp is the most striking example, changing gradually from microzooplankton to larger zooplankton to a more diversified benthic and planktonic diet and finally switching to herbivory as the pharyngeal teeth develop.

A further common feature of the early life history of all the cultured carps is their rapidity of growth and development from small hatchlings (5-8 mm; 2-5 mg) to large active postlarvae and fry. Common carp hatchlings can resorb most of their yolk sacs within 24 hours of hatching at 25°. Moreover, fry can reach 10-15 mg within 5 days and 50-60 mg within 10 days. This growth requires a large food intake (Table 8.3). Carp fry are exceptionally good at capturing living and non-living food items.

Hatchery/nursery feeding practices are largely dependent on the provision of live food organisms such as brine shrimp (*Artemia*) nauplii, rotifers, cladocerans (such as *Bosmina*, *Daphnia* and *Moina* spp.) and mixed plankton. Sometimes a monoculture of a food organism is prepared (for example, *Artemia* nauplii or *Moina micrura*) and sometimes a natural mixed population is allowed to develop (for example, mixed rotifer culture by fertilizing tank water with manure bags). In addition to the provision of live food organisms, supplemental feeds such as the micro-encapsulated egg diet, yeasts and proteinaceous flours have also seen some use. These are not considered in detail here, apart from the egg diet, since their use has not been standardized. Moreover, commercial feed companies are now beginning to market carp starter feeds.

All these feeding practices are covered below, but it should be recognized that they are largely based on empirical grounds, not on any critical assessment of nutritional requirements. In fact, current feeding practices often constitute what may be termed a nutritional overkill. This is acceptable and even desirable for feeding fry and fingerlings since the amounts of feeds needed are relatively small compared to growout feeding requirements. Least cost formulation of feeds is, therefore, less important in hatchery/nursery work than in growout in all aquacultural operations. However, the early rearing of carps on defined artificial feeds under more controlled conditions remains a worthwhile goal. This is because the various combinations of live and artificial feeds and fertilization procedures in current use can cause unpredictable environmental consequences such as blooms of opportunistic plankton

Table 8.7. Food organism preferences of the early life history stages of some Chinese carps (modified from Chang et al. 1983).

Stage/size range (mm)	Grass carp	Silver carp	Bighead carp
Hatchlings (7-9)	Protozoa, rotifers, copepod nauplii	Protozoa, rotifers, copepod nauplii	Protozoa, rotifers, copepod nauplii
Fry (10-12)	Protozoa, rotifers, small cladocerans and copepods	Protozoa, rotifers, small cladocerans	Protozoa, rotifers, copepod nauplii, small cladocerans
Fry (13-17)	Cladocerans, copepods, micro-zoobenthos	Protozoa, rotifers, small cladocerans	Protozoa, rotifers, copepod nauplii, small cladocerans
Fry (18-23)	Cladocerans, copepods, micro-zoobenthos, <i>Chironomus</i> , detritus	Protozoa, rotifers, small cladocerans, phytoplankton	Protozoa, rotifers, copepod nauplii, zooplankton, phytoplankton
Fry (24-30)	Cladocerans, copepods, micro-zoobenthos, detritus, phytoplankton, microalgae, plant fragments	Mainly phytoplankton	Zooplankton and phytoplankton
Fingerlings (up to 100)	Detritus and plants as the pharyngeal teeth develop	Phytoplankton	Mainly zooplankton, some phytoplankton

Table 8.8. Intake of food organisms by common carp postlarvae/fry (modified from Bryant and Matty 1980).

Stage (days from first feeding)	Food organism	Daily intake (% body weight)	Temperature (°C)
Postlarvae/fry (up to 5)	<i>Artemia</i> nauplii	200-250	24
Postlarvae/fry (up to 10)	<i>Artemia</i> nauplii	100-120	24
Postlarvae/fry (up to 10)	<i>Moina</i> spp.	200-300	23-25
Postlarvae/fry	<i>Daphnia carinata</i>	200-300	18-23

species and algae. The approach of using green water in hatchery work is widespread in aquaculture and is usually very successful since the phytoplankton effectively condition the water, lowering ammonia levels and increasing the dissolved oxygen. However, undesirable consequences such as blooms of nutritionally deficient plankton and increased populations of harmful ciliate protozoans in tanks and predatory crustaceans and insects in ponds can also occur. Trends towards better defined feeds and feeding practices in early rearing are discussed below.

FEEDING REGIMEN FOR CARP POSTLARVAE AND FRY

Hatchlings and fry can be reared in hatchery tanks where their food can be provided in adequate quantities and where their development and state of health can be closely watched. This means that the tanks must be indoors or at least in a roofed area well protected from the weather. Advanced fry, at about 10 days old, can then be transferred to nursery ponds for growout to fingerling size.

Carp hatchlings have a short non-feeding period during which the yolk sac is largely, although not completely, absorbed. This can vary from one to five days depending on the temperature and the species. Tanks containing hatchlings should be kept very clean, removing all dead eggs, egg shells and dead hatchlings. This is to prevent the buildup of harmful bacteria, fungi and protozoa. When the hatchling's mouth opens, air is taken in to fill the swim bladder. Active feeding then commences, although the yolk sac is still not completely absorbed and continues to supply energy. The recommended maximum density for first-feeding postlarvae is 100,000/m³.

In recent years, fiberglass, high density polyethylene, polypropylene and other plastic tanks have become widely accepted as essential elements in a high quality hatchery. The details regarding size, material and design vary according to the needs of different hatcheries, but the use of cylindroconical tanks is now becoming widespread (see Chapter 2). These can be used for hatchlings, fry and for the rearing of live food organisms. Their advantages over tanks of other shapes are that they are very easy to keep clean, easy to move around (therefore, giving greater flexibility to hatchery operations than systems set in concrete), easy to fill, empty and observe. Fig. 8.1 gives designs for cylindroconical tanks of three capacities: 0.5, 1.0 and 4.0 m³. The two smaller sizes are particularly useful for mass rearing of the food organisms such as rotifers and *Artemia nauplii* (see below). Fig. 8.2 gives an out-flow filter design.

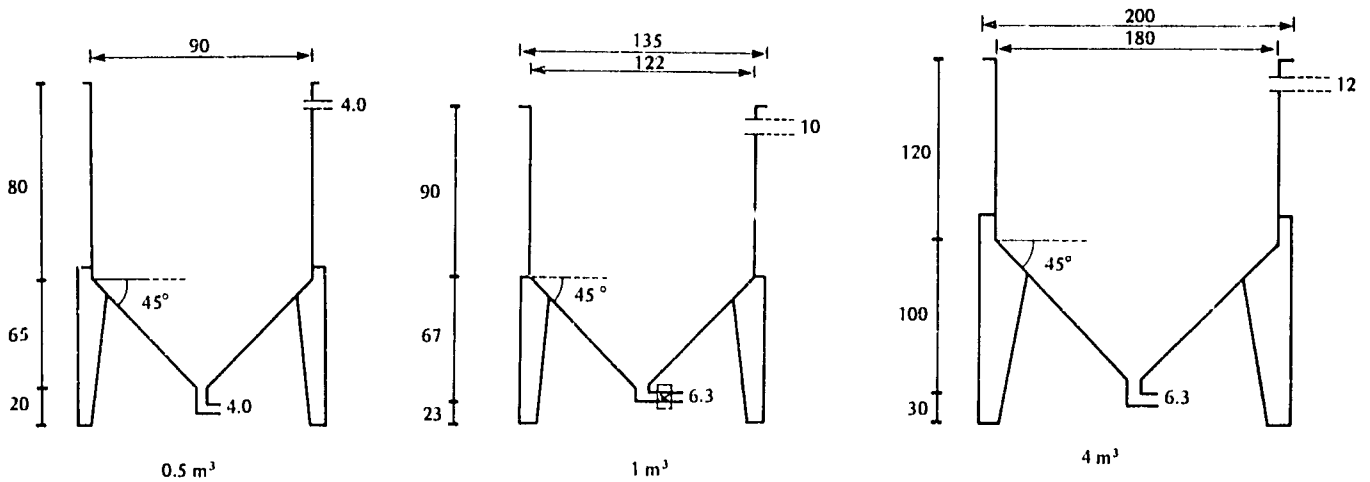

Fig. 8.1

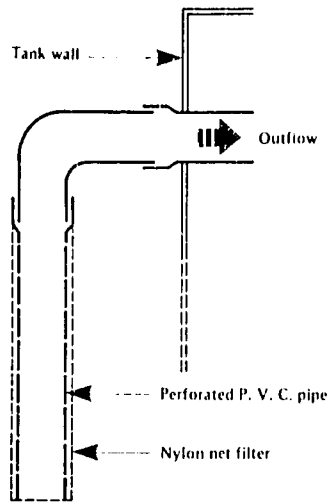

Fig. 8.2

Fig. 8.1. Dimensions for cylindroconical tanks; all have three legs. Units are centimeters. Fig. 8.2. Outflow filter for cylindroconical tanks. Both figures, Dr. Jacques Fuchs of Centre Oceanologique Du Pacifique.

STARTER FEEDS FOR HATCHLINGS AND FRY IN TANKS

Carp fry will accept living and non-living food items. The most widely used starter feeds are dense cultures of rotifers or brine shrimp (*Artemia*) nauplii² and/or the so-called microencapsulated egg diet. Theoretically, any one of these could supply the required nutrients for the first few days of rearing, but reliance on

²The common name 'Artemia' is still tenable, but the latin binomen *Artemia salina* will probably soon fall into disuse as the taxonomy of the brine shrimps is revised.

microencapsulated egg diet alone is not a good idea. It helps to enlarge the gut and make it function but it is not a complete feed. The best carp-rearing results have been obtained by using rotifers as a starter feed and progressing through *Artemia* nauplii to larger crustaceans such as the cladocerans, *Moina*, *Daphnia* and *Bosmina* (Table 8.9). The most important factor for starter feeds is size. First feeding is usually on particles in the size range 50-100 μm . Artificial carp starter feeds are also now becoming available, for example, Ewos C10 "Larvstart" from Sweden. This is a 50-60% protein complete feed, including a vitamin premix and is available in different particle sizes.

Techniques for supplying starter feeds are considered below under the following headings: rotifers, *Artemia* and microencapsulated egg diet.

Table 8.9. Recommended size/density relationships for early rearing of common and Chinese carp fry on live foods.^a

Postlarvae/fry size (mm.)	Food organisms	Food size (μm)	Food density/ liter
6-7	Rotifers	120-180	2,000-5,000
7-9	<i>Artemia</i> nauplii	250-600	1,000-1,500
9	Cladocerans (<i>Moina</i>)	1,000	as required

^aAfter Rothbard (1982).

Rotifers

Rotifers are very easy to culture. In brackishwater and marine larval fish rearing, pure cultures of the rotifer *Brachionus plicatilis* have become the main starter feed used for species with mouths too small to accept *Artemia* nauplii. For carp culture, however, rotifer culture is usually achieved by producing blooms of natural plankton in tanks fertilized with organic manures. *Brachionus* species, for example *B. calyciflorus*, are particularly good feed organisms as they come within the 100-150 μm size range. The brackishwater species *B. plicatilis* can be used to feed carp postlarvae in freshwater. Rotifers taken from mass culture at 10 ppt salinity survive at least 24 hr in freshwater (Lubzens et al. 1984). Larger carnivorous genera from 200-600 μm cannot be eaten by carps as starter feeds.

The culture of mixed rotifers in green water conditions usually provides an excellent starter feed for all cyprinid early fry. Such cultures are usually also rich in large Protozoa, particularly ciliates, which are additional food items. Mixed plankton ensures that the rotifers have a varied diet. Essential fatty acid deficiencies in *Brachionus* as a food for marine fish larvae have been recorded and are caused by reliance on the use of pure cultures of fatty-acid deficient phytoplankton species to feed the rotifers. *Isochrysis galbana* is particularly good alga for culturing *Brachionus plicatilis* of high food value for marine fish larvae. *Dunaliella tertiolecta*, by contrast, is deficient in long chain polyunsaturated fatty acids (PUFA). If pure culture of a phytoplankton/rotifer species combination is envisaged for carp rearing purposes, then the possibility of such deficiencies should be borne in mind.

Artemia nauplii

For hatchlings/fry of 7-9 mm, *Artemia* nauplii can provide a complete feed. In fact, carps, particularly common carp seem much less sensitive to differences in the quality/origin of *Artemia* cysts than most cultured brackishwater and marine fish. Tables 8.10-8.12 give some results from a recent study on *Artemia* cysts from various sources used to rear common carp fry. *Artemia* is a saline water organism,

Table 8.10. Characteristics of *Artemia* cysts used to rear common carp postlarvae: ET50 = median effective time for 50% reduced swimming activity of nauplii transferred to freshwater (nauplii only moving appendages on the container bottom); LT50 = median lethal time for nauplii transferred to freshwater (modified from Vanhaecke and Sorgeloos 1983).

Source of cysts	Hatching output (mg nauplii/g of cysts)	Naupliar harvesting time (hours after hatching)	Naupliar dry weight (μ g)	ET50 LT50 (hours)		Type of <i>Artemia</i> strain B: bisexual P: parthenogenetic
				ET50	LT50	
San Francisco Bay, CA-USA batch n ^o 288-2596	435.5	24	1.63	6.5	26	B
San Pablo Bay, CA- USA batch n ^o 1628	497.7	24	1.92	5.9	28	B
Macau, Brazil batch n ^o 871172	529.0	24	1.74	7.0	27	B
Great Salt Lake, UT-USA batch n ^o 185	467.0	24	2.43	6.8	26	B
Shark Bay, Australia batch n ^o 114	537.5	29	2.47	5.9	37	P
Chaplin Lake, Canada harvest 1978	400.4	27	2.04	4.2	16	B
Lavalduc, France harvest 1979	561.8	31	3.08	8.0	38	P
Tientsin, People's Republic of China harvest 1978	400.5	29	3.09	6.8	33	P
Margherita di Savoia, Italy harvest 1977	458.2	29	3.33	7.6	36	P

Table 8.11. Survival and weight of common carp hatchlings/fry fed *Artemia* nauplii from various sources. Data suffixed by the same letter are not significantly different ($p < 0.05$).^a

Source of cysts (see Table 8.10 for details)	Survival (%)	Mean individual weight after 7 days (mg)		Mean individual weight after 14 days (mg)	
		\bar{X}	S	\bar{X}	S
Margherita di Savoia	94.3	31.9 ^a	2.0	188.4 ^a	8.0
Tientsin	96.7	32.2 ^a	2.1	184.9 ^a	5.3
Shark Bay	95.7	31.8 ^a	2.1	180.4 ^{a,b}	5.2
Lavalduc	95.2	31.0 ^a	2.8	179.5 ^{a,b}	5.5
Macau	95.7	30.3 ^a	2.2	173.1 ^{b,c}	2.9
Great Salt Lake	93.3	29.7 ^a	1.5	170.7 ^{b,c}	2.3
San Pablo Bay	93.3	29.9 ^a	2.3	169.5 ^{b,c}	5.1
San Francisco Bay	93.3	29.9 ^a	3.6	166.4 ^c	12.3
Chaplin Lake	95.2	24.6 ^b	0.9	143.4 ^d	0.2

^aAfter Vanhaecke and Sorgeloos (1983).

Table 8.12. Bioeconomical evaluation of the use of specific *Artemia* cyst batches from various geographical origins for carp hatchlings/fry.^a

Source of cysts (see Table 8.10 for details)	Quantity of cysts needed for one carp larva (in mg)		Quantity of cysts needed for the production of 1 g carp biomass (in g)	
	In 1 week	In 2 weeks	In 1 week	In 2 weeks
Lavalduc	24.6	174.0	0.79	0.98
Sherk Bay	25.7	181.9	0.81	1.01
Macau	26.1	184.9	0.86	1.08
Margherita di Savoia	30.2	217.7	0.95	1.16
San Pablo Bay	27.8	196.4	0.96	1.17
Great Salt Lake	29.6	209.3	1.00	1.24
San Francisco Bay	31.7	224.5	1.06	1.36
Tientsin	34.5	244.1	1.07	1.32
Chaplin Lake	34.5	244.1	1.40	1.72

^aAfter Vanhaecke and Sorgeloos (1983).

hence, the need to evaluate its survival time in freshwater conditions. The tables show that while survival of common carp fry is good on *Artemia* from all sources, a bioeconomical evaluation based on price, hatching rate, naupliar size and nutritional quality does permit sources to be ranked in order of preference. However, sources of *Artemia* cysts are continually changing, batches vary in quality and prices also vary. Therefore, the data in these tables are to be taken as an *example* of the variation between sources and *not* as a recommendation for buyers. For up-to-date information, hatchery operators are advised to contact the *Artemia* Reference Center, State University of Ghent, J. Plateaustraat 22, B 900 Ghent, Belgium. Reference cysts of known characteristics (hatching success, biometrics, essential fatty acid content and pesticide content) are available from this Center for fundamental or applied research work. They are known as Reference *Artemia* Cysts (RAC). They are small-sized, contain good sources of PUFA and low chlorinated hydrocarbon levels and have been tested with a wide range of fish and crustacean larvae.

Artemia cysts can be simply incubated in seawater (natural or artificial) to provide nauplii, for example, 3 g cysts/liter of seawater (around 35‰ salinity). The hatched nauplii must be separated from the hatching debris which may otherwise block the digestive system of the fish hatchlings if ingested. However, recently a method known as decapsulation has gained popularity since it makes naupliar hatching easier and increases hatching success. Decapsulated cysts can also be used as food before they hatch.

The following method is used for decapsulation of 10 g of cysts (details as published by Rothbard 1982):

Step	Procedure
1	Immerse the <i>Artemia</i> cysts in 2 liters of strongly aerated seawater. This rehydrates the cysts.
2	Pour through a 150-200 μm net and wash several times with seawater.
3	Make a solution of 292.5 ml seawater plus 5 g of active sodium hypochlorite.
4	Pour the cysts into the solution and stir in slowly and carefully 7.5 ml of 40% sodium hydroxide solution. The dilution of this strong alkali generates heat so addition must be very slow and with stirring. The temperature must not rise above 40°C since this will kill the <i>Artemia</i> . Check with a thermometer and add small pieces of ice if necessary. Stir constantly.
5	The suspension of cysts will change color within 7-15 minutes as decapsulation occurs. At this point, rinse the cysts again in seawater using the fine mesh net and continue rinsing until the smell of hypochlorite has disappeared.
6	Place the decapsulated cysts in 200 ml of seawater and 0.5 ml of 1% sodium sulphite with stirring. This neutralizes any remaining hypochlorite. Stir for several minutes.
7	Let the decapsulated cysts sink to the bottom of the vessel and pour off any floating debris.
8	Incubate decapsulated cysts in seawater for hatching in the normal manner.

Microencapsulated egg diet

Whole chicken egg is one of the most well-balanced foods and has long been used as a yardstick in nutritional science. Table 8.13 shows its composition.

Hard-boiled eggs have been used as supplemental feeds in fish rearing for a long time. For microencapsulated egg diets, however, the principle is to mix whole egg homogenate with boiling water, whereupon a suspension of miniature hard-boiled eggs is formed—each yolk particle being encapsulated in a coating of denatured albuminous protein. The procedures for this are as follows (after Chow 1980; Rothbard 1982):

Step	Procedure
1	Break egg into a heat-resistant container.
2	Beat egg vigorously or homogenize with a mechanical blender.
3	Pour rapidly (approximately 150 ml for each egg) <i>boiling</i> water into homogenate while stirring constantly. A fine, opalescent suspension is obtained.
4	Make up to desired volume with cold water. A 50 g egg contains about 12 g dry matter.
5	Feed by the spoonful or scoopful directly to fish. The feed may also be applied as a spray using a "knapsack"-type sprayer.
6	Store unused feed in a sealed container at 0-4° C.

Table 8.13. The nutrient composition of chicken egg.^a

	Whole Egg	Egg White	Egg Yolk
Protein (%)	48.8	76.9	32.8
Fat (%)	43.2	—	62.2
Gross energy (kcal/kg)	5,830	3,070	6,910
Metabolizable energy (ME) (kcal/kg)	4,810	2,533	5,700
ME: protein ratio	9.8	3.3	17.3
Calcium (%)	0.2063	0.0427	0.2653
Phosphorus (%)	0.873	0.282	1.020
Amino Acids (%)			
Arginine	2.968	4.179	2.369
Cystine	0.887	1.282	0.526
Isoleucine	2.734	4.307	1.896
Leucine	4.063	6.273	2.790
Lysine	3.047	4.427	2.369
Methionine	1.562	2.700	1.563
Phenylalanine	2.500	4.427	1.316
Threonine	2.500	3.692	1.843
Tryptophen	0.887	1.350	0.577
Tyrosine	1.952	3.076	1.316
Valine	3.674	5.025	2.263

^aAfter Chow (1980).

As stated above, this feed is best regarded as supplemental to a live food diet. The best principle for feeding carp fry is to provide them with an abundance of food items so that growth can be rapid, always taking care, however, not to foul the tank with decomposition of uneaten food. Uneaten egg diet is particularly dangerous since its decomposition generates hydrogen sulphide (H_2S).

The microencapsulated egg diet can also be modified as follows for supplemental feeding to advanced fry which require larger food items:

Step	Procedure
1	As above.
2	As above.
3	Pour homogenate directly into boiling water. Amount of stirring depends on feed particle size desired. Initially, strands of cooked egg are formed. Dispersal of egg yolk remains the same. Yolk is still encased in denatured (cooked) albumin.
4	As above.
5	Feed resuspended material directly to fish. Do not apply with sprayer as this will result in feed particles of undesirably small size for large fry.
6	As above.

Alternatively:

Step	Procedure
1	As above.
2	Add 50 ml water and process as above.
3	Steam homogenate in same container or after transfer to appropriate dish or bowl. A custard made up of the solidified egg emulsion is formed.
4	Feed custard directly to fish after breaking it up into desired size.
5	Store unused custard in tight container under refrigeration.

CLADOCERANS ("WATER FLEAS") AS FEED FOR CARP FRY BEYOND STARTER DIETS

Cladocerans are used for feeding fry large enough to accept larger food items than rotifers and *Artemia nauplii*. Cladocerans are cultured in small ponds, tanks or plastic pools in a similar manner to that described above for rotifers. The most common genera cultured are *Bosmina*, *Moina* and *Daphnia*. *Moina* is particularly important as a fry and fingerling food organism in warmwater aquaculture in Asia. Culture methods involving soil and animal manure addition to pond water have been described for *Moina macrocopa* in the Philippines since 1921. However, soil is not really necessary.

Essentially, the methods for all cladoceran culture rely on animal manure. For example, *Moina micrura* in India is cultured in plastic pools by an initial fertiliza-

tion with fresh cowdung and groundnut cake at a rate of 250-350 and 50 ppm, respectively, followed by subsequent applications of half these quantities every four days. The cultures are seeded with 2-5 ml *Moina* collected from local sources. This system can yield a harvest of 30-70 ml of *Moina* and other plankton, every two days from a 300-liter pool for about a 12-day period. These cultures are not pure cultures of the desired organism. They are best termed semi-pure. In order to get a high percentage of the desired organism, the original seeding should be done very carefully, with care not to introduce other species and all water should be tap water or pond water filtered through fine bolting silk. The *Moina* or other cladocerans can be collected and fed directly to fry in rearing tanks or used to inoculate outside fertilized ponds. The rate of inoculation for outside ponds is 30-50 ml *Moina*/ha.

FEEDING ADVANCED FRY AND FINGERLINGS IN NURSERY PONDS

The provision of foods for advanced fry and fingerlings of cultured carps is usually achieved by fertilization of nursery ponds to stimulate the production of plankton, benthic microalgae and micro- and meiofauna with supplemental feeding of powdered feeds such as rice bran and peanut cake. Here again, feeding practices have been developed empirically and *not* on any critical analysis of nutritional requirements. Pond fertilization with organic manures and inorganic fertilizers is discussed in detail in Chapter 5.

Table 8.14 gives some selected information on current feeding practices in carp rearing in Asia.

Table 8.14. Selected additional information on the provision of live and artificial foods for hatchlings, postlarvae, fry and fingerlings, presented at an Asian Regional Workshop on Carp Hatchery and Nursery Technology, Manila, 1-3 February 1984; B = bighead; C = common carp; Ca = catla; G = grass carp; M = mrigal; R = rohu; S = silver carp.

Country (Location)	Species	Details of feeding practices ^a
Bangladesh	C, Ca, G, M, R	Postlarvae fed boiled egg yolk which is sprayed over the tank for 15-20 minutes every 2-4 hours; 4-5 day-old fry reared in manured, predator-free ponds with supplemental feeding after 2-3 days with mustard oilcake: rice bran (1:1); this feeding continues through fingerling growth; feeding rates are based on original stocking weight (W) with 2 feeds/day as follows: Week 1, 3x W; Week 2, 4x W; Week 3, 6x W; Week 4, 8x W; Week 5, 10x W.
Burma	C, Ca, M, R	Postlarvae fed 4-5% body weight/day of very fine rice bran: peanut oilcake (1:1) split into 2 daily feeds for first 4 days of rearing; similar supplemental feeds given to fry/fingerlings in manured, predator-free nursery ponds; notonectid predators eliminated by using emulsion of vegetable oil (e.g., peanut oil) at 50-60 kg/ha + one-third of its weight of cheap soap.
India	All carps	Various fertilization and supplemental feeding practices in fry/fingerling ponds; feeds are based on groundnut oilcake, rice bran and fish meal.
Indonesia (South Sumatra, West Java)	Mainly C	Postlarvae are usually stocked into fertilized, manured, predator-free ponds 2-3 days after hatching; supplemental feeding with hard boiled egg yolk and very fine rice bran, an alternative fry food is ground extracted soybean flour; fingerlings are fed rice bran plus small quantities of waste palm oil meal, soya mill waste residue or waste groundnut oil meal; other better fingerling foods include rice bran: fish meal mixtures and chicken broiler starter feed.
Nepal (Terai and Kathmandu Valley)	All carps	Hatchlings/postlarvae receive boiled or beaten egg diet twice a day for 3-5 days once feeding commences, which is then substituted slowly with soya or wheat flour before fry transfer to fertilized predator-free ponds; a new dry diet for nursing is fish meal, 20%; wheat flour, 24.8%; maize flour, 20%; soya flour, 20%; oilcake, 5%; meat meal, 5%; bone meal, 5%; poultry feed mineral supplement, 0.1%; poultry feed vitamin supplement, 0.1%.

Continued

Table 8.14. (continued)

Country (Location)	Species	Details of feeding practices ^a
Pakistan (Punjab)	Mainly C, R	Various: 1) hatchlings receive egg yolk diet for 1st day, then postlarvae are fed mass-cultured rotifers for 7-8 days, before transfer to previously limed, manured, predator-free ponds; 2) as 1) but postlarvae/fry kept in concrete tanks, feeding after the rotifers a mixture mass-cultured <i>Daphnia</i> sp. + a dried powdered diet of composition 12 egg yolks; 20 kg dried tilapia meal (made from grinding whole dried 25 g size <i>Oreochromis mossambicus</i> : 1 tin (0.5 kg) of Complan baby food (Glaxo).
Philippines	Mainly C, R	Reliance on natural feeding (rotifers, <i>Daphnia</i> and <i>Cyclops</i>) in manured ponds; no supplemental feeding during the first 2 weeks, fine rice bran given thereafter.
Singapore	Mainly B, C, G, S	Mass-cultured <i>Moina micrura</i> fed as sole food to fry for 10 days (up to 1.5 cm length) gives 95-99% survival; late fry and fingerlings fed 5% body wt/day on carp grower bran in predator-free nursery ponds (composition: 30% soybean meal; 12% fishmeal, 13% meat and bone meal; 20% rice bran; 3% fat, 13% tapioca meal; 2% molasses; 20% vitamin/mineral microingredients.
Sri Lanka	All carps	Postlarvae and fry are fed the microencapsulated egg diet for first 2 days, thereafter supplemental feeding of powdered foods such as rice bran, soybean, maize meal, peas, coconut residue cake; late fry and fingerlings reared in fertilized, predator-free ponds with supplemental feeding of various mixtures of rice bran, soybean, maize, coconut residue cake, chicken feed and fishmeal.
Taiwan	B, C, G, S	Various: for postlarvae and fry the most common first feed is steamed egg yolk; others are soybean milk, powdered milk and pig blood meal alone or combined; 3 light feedings per day at 3-4 hr intervals with no feeding at night; fry in manured nursery ponds fed on <i>Daphnia</i> for about 3 days, then steamed egg yolk and soybean milk for 7 days, then ground peanut cake at 4-10% body wt/day.
Thailand	B, C, G, R, S	Various: first-feeding with hard-boiled egg yolk + soybean milk and wheat flour; a supplemental nursery food in use for C is fishmeal, 30%; rice bran, 45%; peanut meal, 24%; vitamin/premix, 1%.
Vietnam	Mainly C, plus B, G, S	Fry are reared in small manured ponds, water is filtered to prevent predator entry; stocking densities of about 200/m ² ; supplemental feeding with rice flour, wheat flour and soybean meal all of which are cooked during the first week of feeding, uncooked thereafter; fingerlings are fed rice bran, soybean cake. Fry/fingerling ponds are periodically fertilized with manure.

^aMuch of this information is incomplete since hatchery operators do not usually work with standardized feeding procedures. Feed composition and feeding rates are varied according to availability of components and visual assessment of fish and water conditions. This table is a selected review of current practices, *not* a recommendation to adopt them.

Trends in Artificial Feeds for Postlarvae, Fry and Fingerlings

GENERAL CONSIDERATIONS

In the future, feed manufacturers will continue to improve carp growout and broodstock feeds, striving for least cost formulation, and using cheaper alternatives to fish meal and animal proteins. The most important developments, however, are likely to occur in hatchling, fry and fingerling nutrition as complete feeds are produced to take the place of live food organisms. Research on the nutrition of carp fry and fingerlings is continually being carried out and the results are being used to formulate artificial feeds. The provision of complete artificial feeds at realistic prices would constitute a considerable advance over the use of live food organisms and location-specific fertilization/feeding practices.

For grass carp fry, high protein feeds in the 41-53% protein range seem to be required and other species are probably similar. Experimental rearing of grass carp fry using yeast (*Candida lipolytica*) as a protein-rich feed has been very successful. Table 8.15 gives a comparison of the composition of the yeast and fishmeal.

Table 8.15. Analysis of the artificial food-yeast *Candida lipolytica* in comparison to fishmeal.^a

	Yeast	Fishmeal		Yeast	Fishmeal
Dry matter — %	94.4	89.1	Amino Acids:		
Ash — %	6.3	24.7	Histidine	2.1	2.4
Organic substance (% of dry matter)	93.7	75.3	Leucine	7.2	7.3
Crude protein — %	64.4	71.8	Isoleucine	4.8	5.7
Fat — %	6.3	2.4	Lysine	7.5	9.0
Amino Acids:			Methionine	1.8	2.7
Alanine	7.4	—	Phenylalanine	4.4	4.2
Arginine	5.2	5.8	Proline	4.1	—
Asparagine	9.0	—	Serine	4.5	—
Cysteine	1.1	0.9	Threonine	4.9	3.9
Glutamine	12.7	12.5	Tyrosine	3.4	3.0
Glycine	4.9	6.1	Valine	5.7	5.1
			Tryptophan	1.3	1.0

^aFrom Appelbaum (1977).

An experiment in which grass carp postlarvae were fed on yeast supplemented with a 4.5% vitamin/mineral premix and 5.5% meat extract produced excellent results (Fig. 8.3). A trial with common carp has shown that the yeast feed outperforms a conventional *Artemia nauplii* plus boiled egg yolk diet (Fig. 8.4) (Appelbaum and Dor 1978). The total amount of dry yeast feed required here was about

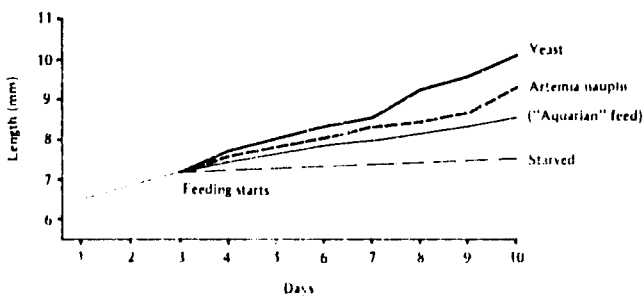

Fig. 8.3

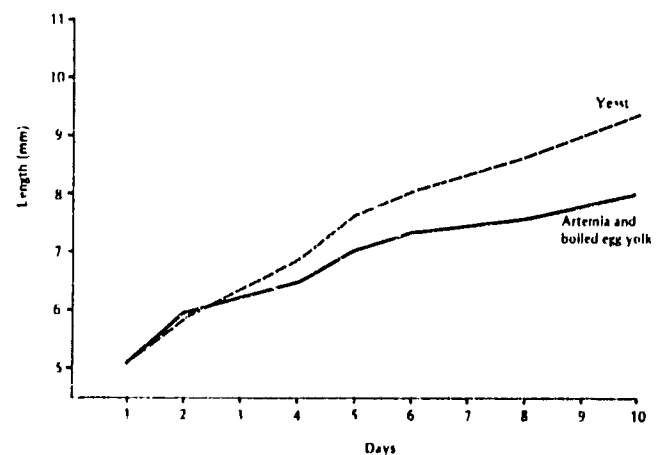

Fig. 8.4

250 g for 50,000 hatchlings in a 100 x 100 x 60 cm plastic tank. Feed was scattered over the water surface 6-7 times a day: 15 g/day for the first few days with grain size not larger than 250 μ m increasing to 25 g/day of grains up to 500 μ m from the third day and up to 40 g/day of 750 μ m grains towards the end of the trial. Such trials require repetition and scaling-up for commercial use. It is very important to remember that yeasts, like all protein-rich feeds, can cause tank fouling, depletion of oxygen and buildup of H_2S unless strict hygiene is followed. Self-cleaning tanks with fast water exchange or cylindroconical and specialized carp rearing tanks are essential.

Fig. 8.3. Growth of grass carp postlarvae/fry fed on different diets. Water temperature 24°C; stocking density approximately 125 individuals/liter; data represent averages of 30 measurements each (from Appelbaum and Ulan 1979).
Fig. 8.4. Growth of common carp postlarvae/fry fed with dry yeast feed or *Artemia* plus boiled egg yolk (from Appelbaum and Dor 1978).

Krill (*Euphausia superba*) has also been tried as a protein source for feeding advanced common carp fry since krill meal from Antarctic fisheries may soon become widely available. The general result is that krill meal is an acceptable substitute for fishmeal in high protein (42%) feeds.

FINGERLING FEED DEVELOPMENT

Experiments have been performed to determine the utilization of various single cell protein-based feeds for common carp fingerlings. The general result is that yeasts and bacterial proteins are well utilized whereas plant proteins, such as *Spirulina* and extracted soybean protein concentrate, are not. It is possible that future fingerling feeds may be based on petroyeasts or methanophilic bacteria.

It has also been shown that common carp fingerlings will do well on high carbohydrate feed. Recent research results indicate that high cassava and rice feeds give excellent results for fingerlings of about 4 g (Fig. 8.5). However, more work needs to be done with different species and over wider ranges of fish size and levels of carbohydrate inclusion.

Grass carp fingerlings will grow very well on duckweed (which is usually around 30% dry weight crude protein). Grass carp fingerlings have been grown in intensive tank culture from 2.7 to 72.7 g in 88 days on the duckweed *Lemna minima* consuming 4 to 7% body weight/day. It is probable that grass carp fingerlings receiving dry complete pelleted feeds in intensive tank culture could grow much faster than this. Further investigations are required to exploit the growth potential of this species.

The planktivorous carps are probably best left to exploit their preferred natural feeding niches as fingerlings and through growout, rather than attempting to develop feeds for intensive culture.

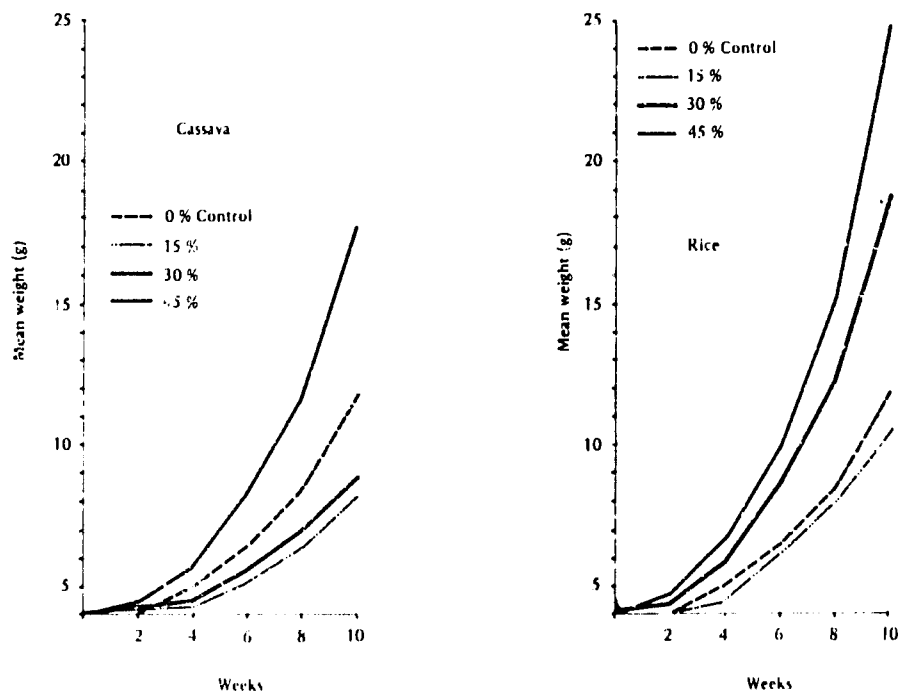

Fig. 8.5. Effects of different levels of dietary cassava and rice on weight gain of mirror carp fingerlings (from Ufodike and Matty 1983).

Feed Analysis and Formulation

The following information is from Jauncey and Ross (1982), "A guide to tilapia feeds and feedings", since their recommendations for analysis, quality control and formulation principles can also be applied to carp feeds. The feeds in question are best considered *complete* rather than *supplemental* feeds.

FEED ANALYSIS AND QUALITY CONTROL

Much information can be gained about the nutritional composition of any given feedstuff by consulting tables of average analyses of the material in question. Useful references to consult for this are: "Tropical Feeds" (Gohl 1975) and "Nutrient requirements of warmwater fishes" (NRC 1977, 1983). However, it should be appreciated that the composition of any given feedstuff may vary enormously from batch to batch. It is desirable, therefore, to have batches of ingredients and the finished feed sampled and analyzed: at the very least proximate analysis for protein, lipid, fiber, ash and carbohydrates. Ideally, analyses should also be carried out for essential amino acids, essential fatty acids and minerals, although this is often not practicable. The levels of suspected toxins should also be examined in susceptible feedstuffs, e.g., aflatoxins in oilseed meals, gossypol in cottonseed meal, isothiocyanates in rapeseed meal, trypsin inhibitor in soybean meal, and the peroxide value of lipid ingredients.

In most countries, special laboratories exist to perform such analyses routinely. Indeed, many large feed manufacturers have their own laboratories. The procedures required to perform such analyses may be found in the AOAC manual (Horwitz 1980).

It is essential that finished feeds are stored for the shortest possible time and under as dry and cool a condition as possible.

FEED FORMULATION

Feed formulation is the combination of raw materials to satisfy the preestablished nutrient requirements of the species and age of fish. Raw materials should be selected on their ability to supply particular nutrients (e.g., protein, energy, essential amino acids and essential fatty acids) at the lowest cost. This assumes that nutrients present in different feedstuffs have the same nutritional value, which permits the combination of many different nutrient sources in different proportions to satisfy a given set of nutrient requirements for a particular fish. However, the fact that a nutrient is chemically measurable in a given feedstuff does not necessarily mean that it is biologically available. Feed formulation usually follows a certain sequence of virtually trial and error steps:

Step	Procedure
1	Balance the crude protein level.
2	Check and balance the energy content.
3	Check the levels of essential amino acids and essential fatty acids and if necessary, return to step 1 readjusting the protein until essential amino acid requirements are satisfied, and return to step 2 to adjust the lipid sources until the essential fatty acid requirements are satisfied.

Before proceeding with the above steps, however, it is usually advisable to use least-cost or best-buy calculations to compare the cost of supplying a particular nutrient from different feedstuffs. For example:

If cottonseed meal costs US\$0.4013/kg and contains 54% protein:

$$\text{Cost/kg protein} = \frac{0.4013}{0.54} = \text{US\$0.7431/kg}$$

If groundnut meal costs US\$0.3071/kg and contains 44% protein:

$$\text{Cost/kg protein} = \frac{0.3071}{0.44} = \text{US\$0.6980/kg}$$

Thus, although the groundnut meal in question has a lower protein content, it is still a better buy as it costs less per kg of protein supplied.

If rice polishings contain 2,700 kcalDE (digestible energy)/kg and cost US\$0.1604:

$$\text{Cost/kcal} = \frac{0.1604}{2,700} = \text{US\$0.000594/kcal}$$

If maize-hominy feeds contain 4,300 kcalDE/kg and cost US\$0.2137:

$$\text{Cost/kcal} = \frac{0.2137}{4,300} = \text{US\$0.000496/kcal}$$

Thus, as an energy source the maize-hominy feed is cheaper per kcal of energy supplied than the rice polishings even though it is more expensive.

Similar calculations can be performed to find the least-cost feedstuff for supplying any given nutrient.

Balancing crude protein level

Protein is the most expensive component of carp feed and is the first nutrient considered in diet formulation. Protein sources are first selected from those available on their cost per unit of protein supplied and their amino acid profile. Supposing it is desired to formulate a 30% protein carp feed from cottonseed meal (54% protein) and maize germ meal (20% protein), a square is constructed thus:

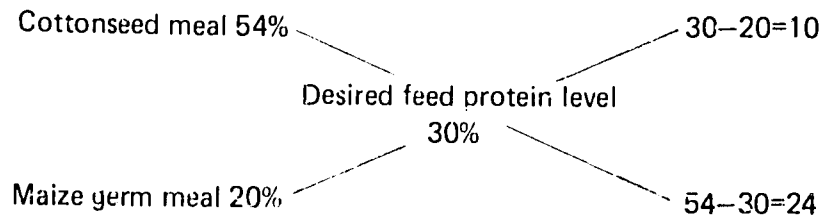

The protein level of the feed is subtracted from that of each of the feedstuffs in turn and the answer is placed at the opposite corner to the feedstuff ignoring positive or negative signs. The two figures on the right hand side of the square are then added together (10+24=34). To obtain the 30% protein carp feed we need:

$$\text{Cottonseed meal } \frac{10}{34} \times 100 = 29.41\%$$

$$\text{Maize germ meal } \frac{24}{34} \times 100 = 70.59\%$$

Thus, to make 100 kg of the 30% protein carp feed we need 29.41 kg of cottonseed meal and 70.59 kg of maize germ meal. If there are more than two protein sources to be taken into consideration then this is achieved by grouping the feedstuffs, on the basis of their protein content, into protein supplement (> 30% protein) and basal feed (< 30% protein).

For example, the 30% protein carp feed could be formulated from rice polishings (14% protein) and soybean meal (48% protein) in addition to the cottonseed

and maize germ meal used above. The protein supplement is an equal mixture of soybean meal and cottonseed meal and has a protein content of $\frac{54 + 48}{2} = 51\%$. The basal feed is an equal mixture of maize germ meal and rice polishings and has a protein content of $\frac{20 + 14}{2} = 17\%$.

To obtain the desired 30% protein level, a square is constructed thus:

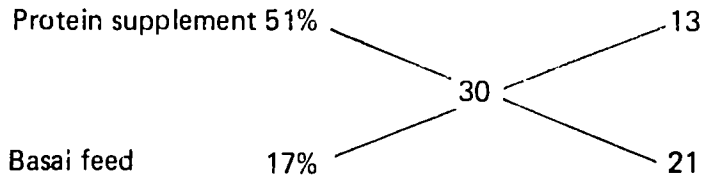

We thus require $\frac{13}{34} \times 100 = 38.24\%$ protein supplement

and

$\frac{21}{34} \times 100 = 61.76\%$ basal feed

One hundred kg of feed would, therefore, contain 19.12 kg each of soybean meal and cottonseed meal and 30.88 kg each of maize germ meal and rice polishings.

Exactly the same procedure can be used with digestible energy values to arrive at the final desired digestible energy content of the feed.

COMPLETE FEED FORMULATION

The procedure used above accounts for 100% of the feed and leaves no room for supplementary lipid, binders, vitamins and minerals. If we assume that all the supplements combined account for 10% of the feed then the calculation is adjusted by multiplying the figures derived from the square by 90 instead of 100.

So the procedure for formulation is as follows:

Step	Procedure
1	Use least cost analysis to select protein and energy sources.
2	Ensure that these sources will provide the desired levels of essential amino acids (EAA) and essential fatty acids (EFA).
3	Remember that a better nutrient balance is likely to be achieved by using several feedstuffs in combination.
4	Balance crude protein level.
5	Balance digestible energy level.
6	Calculate the levels of EAA and EFA in the finished feed (if possible) and if these do not satisfy the requirements of the carp, repeat steps 4 and 5.

The best way to undertake step 6 is to produce a feed formulation table (see Tables 8.16, 8.17).

This method of diet formulation may appear laborious at first, but practice and experience allow the feed formulator to "guesstimate" the required levels and types

Table 8.16. A worksheet for diet formulation with respect to major nutrients and costs (after Jauncey and Ross 1982).

Ingredient	% in		Cost/100 kg		% Protein		% Lipid		% CHO ^a		% Fiber	
	Feed	Ing ^b	Feed	Ing ^b	Ing	Feed	Ing	Feed	Ing	Feed	Ing	Feed
Totals	100	—	—	—	—	—	—	—	—	—	—	—
Req ^c	100	—	—	—	—	—	—	—	—	—	—	—

^aCHO — digestible carbohydrate
^bIng — ingredient (feedstuff)
^cReq — requirement

Table 8.17. A worksheet for diet formulation with respect to essential amino acids (after Jauncey and Ross 1982).

Ingredient	% in		% Arg ^a		% Hist		% Isoleu		% Leu		% Lys		% Meth		% Phen		% Thr		% Try		% Val	
	Feed	Ing	Feed	Ing	Feed	Ing	Feed	Ing	Feed	Ing	Feed	Ing	Feed	Ing	Feed	Ing	Feed	Ing	Feed	Ing	Feed	
Totals	100	—	—	—	—	—	—	—	—	—	—	—	—	—	—	—	—	—	—	—	—	—
Req	100	—	—	—	—	—	—	—	—	—	—	—	—	—	—	—	—	—	—	—	—	—

^aAbbreviations for the ten essential amino acids.

of feedstuffs and then use the calculations to check that nutrient requirements are satisfied, drastically shortening the whole process.

LINEAR PROGRAMMING

The best method of diet formulation is to use an appropriate computer program. The computer stores the complete analysis and costs of the available feedstuffs and the required nutrient profile of the feed. It will then perform calculations to prepare a least-cost formulation for any required feed virtually instantaneously. Such computer software can be bought off the shelf and the hardware systems are readily available. However, such systems are only economically viable if the quantities of feed being produced are very large.

PROCESSING INGREDIENTS

Feedstuffs are processed in order to increase digestibility and pelletability and to inactivate specific antinutritional factors such as growth inhibitors or toxins. The simplest form of feedstuff pre-treatment is milling which is applied to materials with low moisture content. This reduces particle size to improve pelletability and digestibility. Pellets containing feedstuffs milled to a uniformly small particle size are also much more water stable. There are many different types of milling equipment available and their use depends, to some extent, on the nature of the feedstuff, particularly the lipid and fiber contents. Ball mills, hammer mills and cutter mills are the three main types employed.

Heat treatment is also often used for drying feedstuffs, destroying antinutritional factors (such as the trypsin inhibitor in soybean) or in the extraction of oil from oilseeds. Wet heat (steam) improves the nutritional value of any feedstuff or feed containing large quantities of starch by gelatinization (conversion to dextrans and oligosaccharides) which results in the carbohydrates becoming more digestible. Gelatinization of the starch also greatly improves its binding properties. There are many different kinds of pelleting equipment available. The simplest (for processing small quantities) are large commercial food mixers which can be used to produce a wet-extruded diet which is subsequently dried. On a larger scale, machines exist for producing dry extruded pellets—these simply force the feed mix through a die under pressure. Their disadvantage is that the pellets produced are extremely hard.

Pellets can be produced in the required sizes from about 2 mm in diameter upwards and, ideally, the length of a pellet should be 2-3 times its diameter. Smaller feed sizes for fry and fingerlings can be produced by crumbling larger-sized pellets and sieving them to the appropriate size although special machines are available for the production of crumbs.

SOME ASPECTS OF FEEDS FOR BROODSTOCK

Sufficient natural food can be produced in a well-managed and adequately fertilized pond large enough to provide qualitative and quantitative nutrition for the stock. A 20 to 40 m² pond surface can produce the necessary food for one female. Utilization of the protein-rich natural food will be improved if a supplement of 1% of the body weight of each breeder is given daily in the form of a carbohydrate-rich grain feed. If the pond surface is less than 20 to 40 m² per female, a complementary protein-rich feed has to be given daily in a ratio of 2 to 2.5% of the body weight. Other suitable supplementary feeds are the protein-rich grains such as soybean, beans, peas, lupins, good brans, oilcakes, etc. Females need a diet rich in animal protein, vitamins and minerals for the development of the oocytes in the ovary. Males do not need such rich feed as the females. The protein content of their supplementary feed can be reduced to about 15 to 20% of crude protein. However, natural food is the most important part of the diet of all the broodstock. Table 8.18 gives a typical feed mix for a supplemental feed for common carp broodstock, containing 29-30% crude protein. If such a feed mixture is not readily available, the feed given to laying hens (in a pelleted form or in a dough but not in dry meal form) can be used. It is given together with about 10% of fish, meat, blood meal, or fresh blood, or with minced parts of other animals, such as fish, frogs, tadpoles, insects (beetles, locusts), earthworms or silkworm pupae.

More information on broodstock nutrition is tabulated in Table 8.19.

Table 8.18. Ingredients and percentage composition of a supplemental feed for common carp broodstock.

fish and/or meat meal (blood meal)	22
wheat, sorghum, corn (or similar grain) and some wheat or rice bran	30
extracted soybean meal	17
lupin, pea or other legumes (partly extracted oilcake)	10
maize	14
flour of alfalfa (lucerne) or clover	5
yeast	0.5
vitamin premix	0.5
mineral premix	0.5
stabilizer	0.5

Table 8.19. Selected additional information on broodstock husbandry and nutrition, summarized from information presented at an Asian Regional Workshop on Carp Hatchery and Nursery Technology, Manila, 1-3 February 1984; B = bighead carp; Ca = catla; C = common carp; G = grass carp; M = mrigal; R = rohu; S = silver carp.

Country (Location)	Broodstock husbandry ^a	Nutrition ^a
Bangladesh	C, Ca, G, M, R: kept in fertilized ponds from which all wild fish previously cleared by drying or use of 3-4 ppm rotenone; various polyculture systems, typical species mix is Ca, 15%; G, 5%; M, 10%; R, 35% plus 5% kalbasu at a total stocking density at about 1,000 kg/ha; C, Ca, kept in separate monoculture ponds, especially important for Ca since they are thought to need a lot of space; C sexes are segregated.	Supplemental feeding is usually at 3% body weight with mustard oilcake: wheat bran (1:1); the mustard oilcake is mixed with water (2:3), soaked for 24 hours and then this mixture is made into food balls with the wheat bran; spent fish transferred to well-manured ponds and fed at 10% body weight/day during recovery.
Burma	C, Ca, G, M, R: some pond fertilization, but heavy reliance and supplemental feeding when natural feeds are in short supply; usually various polyculture species combinations.	Various supplemental feeds and feeding rates with rice bran, peanut oilcake and chopped vegetation; e.g., peanut oilcake: rice bran (1:2) plus equal volume of chopped green fodder (grasses or water hyacinth) during maturation, most spp. receive 3-4% body weight/day reducing to 1-3% in the pre-spawning period.
India	All carps: kept in manured ponds with supplemental feeding; various polyculture combinations; total stocking density 1,000-2,000 kg/ha.	Supplemental feeding at about 1% body weight/day with rice bran: oilcake (1:1).
Indonesia (South Sumatra; West Java)	C: in manured ponds but with heavy reliance on supplemental feeding; stocking density, usually 2,000 kg/ha (some farmers use up to 3,300 kg/ha but this is too crowded); individual fish weight are 300 g-2 kg, 1-4 kg.	Rural farmers feed rice bran mixed with fresh vegetation, waste palm oil and waste ground nut oil; government and private hatcheries feed pellets at 2-3% body weight/day; pellets contain 20-25% protein and maximum 8% fat; a typical pellet mix is rice bran, 50%; fishmeal, 25%; leaf meal, 12%; vitamin, mineral and antibiotic premix, 1%.

Continued

Table 8.19. (continued)

Country (Location)	Broodstock husbandry ^a	Nutrition ^a
Nepal (Terai and Kethmandu Valley)	All carps: kept in manured/fertilized ponds; Chinese and Indian carps stocked at 800-1,200 kg/ha; various polyculture systems depending on which species is the major fish, e.g., 1) S, 40-50%; B or Ca 10-20%; G 15-20%; R and M 10-15%; 2) B or Ca, 40-50%; G, 15-20%; R and M, 10-15%; S, 10-15%; 3) G, 40-50%; R and M, 10-15%; S, 15-20%; B or Ca 10-15%.	Various supplemental feeds based on soya, wheat flour, rice bran and oilcakes at 3-5% body weight/day; green vegetation fed to G.
Pakistan (Punjab)	Mainly C, R, C, sexes separated; all species kept in manured/fertilized ponds with supplemental feeding.	Various supplemental feeds depending on local availability; typical feed contain 30% maize, 30% rice; 20% horse gram, 20% cotton oilcake; some hatcheries use 20% fishmeal from trash marine fish or tilapia (<i>Oreochromis mossambicus</i>) fingerlings grown on site.
Philippines (Rizal Province)	B, C, R, S: all species kept in ponds and crete concrete tanks.	C are fed rice bran and molasses or rice bran plus copra meal (1:1) or rice bran alone, all at 5% body weight/day; B, G and S are fed with rice bran at 5% body weight/day until 5 months before spawning, when they receive instead a 25% fishmeal, 75% rice bran, plus vitamin premix feed; all feeding is split into twice daily.
Taiwan	B, C, G, S: all spp. kept in manured ponds; usual practice is polyculture with fast stocking density 2 tons/ha composed of 200-250 S as main species (2.5-4.0 kg individual wt), with 200-250 G and 20-30 B; alternative is 100-150 B as main species (5-10 kg individual weight) with 100-150 G and 10-20 S; or 150-200 G as main species with 100-150 S and 10-15 B.	Various supplemental feeds-soybean cake, rice bran and peanut cake for B and S; 20-40% body weight/day green vegetation plus 2% soybean cake given as supplemental food for G.
Thailand	B, C, G, R, S: all kept in manured/fertilized ponds; stocking density one fish (2-4 kg) per 20-30 m ² ; various polyculture combinations e.g., 1) G: S: B; 2:1:1 2) G: S: B: C; 4:1:1:4.	B, C, R, S fed 25% protein fishmeal-based pelleted feeds 30-40 days up to expected spawning at various rates; G fed pellets at 1-2% body weight/day plus green vegetation.
Sri Lanka	All carps: kept in manured ponds, but also heavy reliance on supplemental feeds; C monoculture 4,000 kg/ha stocking density, mixed sexes; Ca, M, R, polyculture, 5,000 kg/ha various species combinations; B, G, S, polyculture, various species combinations up to 2,000 kg/ha.	Various feeds: e.g., C, 1-2% body weight/day of rice bran: coconut residue cake (1:1) plus sometimes earthworms or silkworm pupae; Ca, M, R, 1-2% body weight of a 60% rice bran, 35% coconut residue cake, 5% fishmeal feed; G, 20-25% body weight/day of land grasses with 2% body weight/day rice bran: coconut residue cake (1:1) plus germinating rice seedlings and supplemental vitamin E given but stopped 3 months before spawning; B, 2-5% body weight/day of a soybean: rice bran: coconut residue cake (3:2:3); S, as B but 1:1:1.
Vietnam	B, C, G, S: all species kept in manured ponds; C sometimes alone with sexes segregated, stocking 1 kg/5-8 m ² or 1 kg/10-20 m ² ; various polyculture combinations.	Supplemental feeding at 5-7% body weight/day with various feeds depending on local availability of materials; usual balance 10-30% protein: 70-90% carbohydrates; a good feed is rice bran, 70%; fishmeal, 5%; soybean cake, 12%; wheat flour, 10%; fish sauce waste, 3% plus microingredients in mg/kg dry food, CuSO ₄ , 4; KI, 1; MnSO ₄ , 2; CaCl ₂ , 1-5. During the last 2 months before spawning fish (usually C) also receive 1-2% body weight/day of germinated rice (assumed beneficial because of high Vitamin E).

^aMuch of this information is incomplete since culturists frequently change practices based on experience to cope with different species combinations and local conditions. This table is a selected review of current practices, not a recommendation to adopt them.

Chapter 9

Diseases of Cultured Carps

General Considerations

Carps, like other fishes, are affected by a very wide range of diseases and parasites, particularly when they are under stress from poor environmental conditions and inadequate nutrition. Most studies on the prevention and treatment of carp diseases have been carried out in temperate and subtropical situations. This is because the main centers of expertise for such studies are outside the tropics and also because many diseases are more problematic at cold temperatures since the immune response of fish is lessened by the cold. This is particularly true of certain viral, bacterial and protozoan diseases which are most persistent in temperate countries in the winter, spring and early summer.

The standard and widely available textbooks on fish diseases and pathology contain a large amount of information on the common carp. In addition, the handbook by McDaniel (1979) is a very useful general guide for the detection and identification of pathogens. This chapter identifies the major diseases and parasitic infestations likely to affect carps in warmwater culture, summarizes some methods for prevention, treatment and quarantine and lists sources of further information. Much of the information available on carp diseases refers to adult fish. There have far been fewer investigations on diseases of eggs, hatchlings, postlarvae, fry and fingerlings, but those most important are summarized here in a separate section.

Prevention, Prophylaxis and Treatment

It cannot be overemphasized that most outbreaks of disease result from a combination of two factors—the presence of the disease organism and an abnormal state of the affected fish (adverse environmental conditions, poor nutrition, stress and abrasions from handling).

Good husbandry, good nutrition and high water quality are the keys to avoiding disease problems. Strict hygiene should also be observed especially in hatchery work.

For disinfecting and cleaning hatchery tanks, nets and other equipment, a range of compounds is available. For general use, the well-known iodophor disinfectants such as *Mescodyne*, *Buffodine* and *Argentyne* are ideal. These are used, as in agriculture, for cleaning and hosing down concrete structures. Quaternary ammonium compounds (QAC) such as Benzalkonium Chloride, Hyamine 3500 and Roccal are excellent for disinfecting troughs, nets and other equipment. A further class of disinfectants, the N-Chloramines, such as Chloramine T (Argent Chemical Laboratories), is also used for disinfecting tanks and raceways. The QACs and N-Chloramines are relatively nontoxic to fish and have been used as dip, bath or flush¹ treatments against bacterial diseases, for example, 25 ppm Chloramine T for 30 minutes

¹The terminology applied to water-additive treatments can vary, but normally, treatments lasting from a few seconds to a few minutes are called *dips*. Longer immersions up to a few hours are called *baths*, but may be extended to 24 hours; *flushes* are concentrations maintained for a few hours or longer in running water systems.

in trout raceways against bacterial gill disease. However, all disinfectants must be assumed to be toxic to fish. This is particularly true for iodophores and bleach (hypochlorite)-based disinfectants. Potassium permanganate (10 ppm solution) and formalin (200-250 ppm) are among the disinfectants commonly used in Asia for disinfecting spawning tanks. When using any disinfectant, it is essential to ensure that washings are led to a drainage system completely isolated from any fish holding facilities.

Prophylaxis and treatment of fish diseases with drugs (chemotherapy) are complicated by many factors. Very few procedures have been standardized and factors such as temperature, pH and water hardness can affect the potency and toxicity of compounds. Prophylactic treatments in use in Asia are, therefore, empirical, e.g., bathing broodfish in 10-15 ppm furacin or 4-5 ppm acriflavin before transportation; injection of broodfish with 15 mg/kg terramycin in 0.3 ml/kg maximum injected volume after spawning. Treatments are given below for the various diseases, but some general ground rules and advice are given here.

Most important of all, before giving any chemotherapeutic or prophylactic treatment to fish, try it out first on a small representative sample and then allow a 24-hour recovery period before treating a large stock. Also make sure that more than one person checks all dosage calculations and preparation of medication independently. It is easy to make errors, for example, by a factor of ten. The results can be disastrous. It is best, therefore, to write down all aspects of treatment procedures and the response/behavior of the fish in a detailed report book.

Before giving any external treatment (dipping, bathing, flushing) or injections, starve the fish for 12-48 hours. This reduces their oxygen consumption and ammonia production. Maintain good levels of dissolved oxygen throughout treatment. In multiple infections, check the conditions of the gills and treat for gill parasites and diseases first. The gills are the most important organ for survival.

Lists of supplies of drugs, disinfectants, anesthetics and other chemicals for use in aquaculture may be obtained from the Buyer's Guide published annually by Aquaculture Magazine, P.O. Box 2329, Asheville, North Carolina 28802, U.S.A.

The following companies specialize in products for disease prevention and treatment in aquaculture: Syndel International Inc., 8879 Selkirk St., Vancouver British Columbia Canada V6P 4J6; AquaVet, 2242 Davis Court, California CA 94545, U.S.A. and Argent Chemical Laboratories, 14929 N.E. 40th Street Redmond, Washington 98052, U.S.A. These companies have extensive literature on the use of their drug products for fish disease control.

For advice on disease diagnosis and problem solving, the best point of contact is the Institute for Aquaculture, University of Stirling, Stirling FK4 4LA, Scotland, U.K. This Institute is a leading center for fish pathology and is the place from which the Journal of Fish Diseases is published.

Finally, it is very important to note that the procurement and use of drugs is controlled by legislation in many countries to protect consumers of treated fish and to guard against misuse, particularly in antibiotics.

Viral Diseases

Viral diseases are not generally a problem for carps in warmwater conditions, but it is worth mentioning some problems which have been studied intensively in Europe. The condition known as infectious dropsy is really a complex of diseases and includes the spring viraemia of common carp (SVC) caused by *Rhabdovirus carpio* and swim-bladder inflammation (SBI) for which the viral agent may be the

same. The main symptoms of SVC are: gathering of the fish at water outflows, darkening, skin and gill hemorrhages, loss of balance, exophthalmos (bulging eyes) and abdominal dropsy. Infection can occur in common carp of any age. The susceptibility of other carps is not known. SVC appears in the spring and early summer and has caused serious losses in European carp farms. Infected fish which recover never show symptoms of re-infection but probably carry the virus for life as a latent infection. SBI infections are characterized by similar symptoms plus a marked degeneration of the swim-bladder. Usually one of the two chambers of the carp swim-bladder becomes severely shrunken following extensive hemorrhaging and necrosis.

A condition known as epidermal epithelioma or fish pox has been described in common carp in Europe and Israel. There is evidence that this is an infectious disease and may be caused by a virus. The main symptom is epithelial proliferation centered around the lateral line, but the condition is not strictly an epithelioma or papilloma. In advanced stages, the epidermis increases to many times its normal thickness, with finger- or cauliflower-like projections. There are a number of other disease conditions in common carp which are suspected to be of viral origin including gill necroses, but they have not been adequately studied.

There are no effective treatments for viral diseases. Prevention is achieved by high standards of husbandry especially good nutrition, quarantine measures and destruction of infected fish. Vaccination of valuable broodstock is a likely future development.

There is also strong evidence that different strains of common carp show different susceptibility to infectious dropsy and that certain inbred lines are susceptible to epidermal epithelioma while crossbreds are resistant. The future development of breeds resistant to viral diseases is, therefore, a possibility although good husbandry remains the culturist's chief weapon.

Fungal Diseases

The fungus *Branchiomyces* is a serious pathogen in European carp culture, especially in Mediterranean countries. There are two species, *B. sanguinis* which is localized in the gill blood vessels and *B. demigrans* which grows out through the vessels and causes necrosis of the surrounding tissues. It causes a condition known as branchiomycosis or gill rot which is usually followed by total mortality. It occurs particularly in ponds in which there is an abundance of decaying vegetation, such as weeds cut from pond banks and usually at temperatures exceeding 20°C. Treatment by liming has been suggested (150-200 kg calcium oxide/ha), but improvement of water quality is probably a better approach.

The ubiquitous fungus *Saprolegnia* can also affect a wide range of fish species, especially broodstock after handling and stripping. The fungus appears as white/grey mats on the skin and can spread extensively, invading deeper tissues and causing heavy mortalities. *Saprolegnia* can be controlled by the use of malachite green (which *must* be zinc-free grade).

Malachite green can be applied as a swab with a 1% solution (1 g/100 ml), as a dip/bath treatment at 67 ppm concentration for 30 seconds to one minute or as a longer term bath or flush treatment at 1-2 ppm. Prolonged immersion at 0.10 to 0.15 ppm does not generally harm fish and these concentrations can be maintained in ponds for long periods if desired. All concentrations refer to active ingredient.

Malachite green treatments for ponds and aquaria are usually made at 0.1 ppm (active ingredient).² Protective clothing is advisable when handling malachite

²A stock solution should be prepared by dissolving 14 g malachite green in one gallon (3.79 liters) of water. Then use 1 ml of the stock solution per ten gallons (38 liters) of aquarium water or, as a rough measure, one teaspoonful per 50 gallons (190 liters) of pond water.

green and malachite green dust should not be breathed (use a mask or respirator). Green stains on skin and clothing can be decolorized with sodium sulphite.

Valuable broodstock should be given a dip, after handling, to guard against fungal and bacterial infections. No single chemical will give prophylaxis against all possible pathogens, but the following have been suggested:

1. A 30-second dip in 67 ppm malachite green (zinc-free grade) protects against all fungi and probably bacteria (including *Flexibacter columnaris*; see below).
2. A potassium permanganate bath (1 g/100 liters for 90 minutes).

Bacterial Diseases

Bacteria are found in many fish disease conditions both as primary causative agents and secondary invaders of ulcers and other lesions. This complicates the diagnosis of disease condition. For example, pathogenic *Aeromonas* spp. have been associated with infectious dropsy in Indian major carps, and the disease has been reproduced by inoculation of pure bacterial cultures. However, the possibility of viral involvement also cannot be excluded. Diagnosis of ulcerative skin conditions and fin or gill rot is particularly difficult since a wide range of fungi, bacteria (*Aeromonas*, *Pseudomonas* and *Vibrio* spp.) and Protozoa may be present. Such ulcerative conditions and fin rots have recently been described in common carp and rohu in the Punjab (Toor et al. 1983). The conditions were termed hemorrhagic septicaemias and were complicated by heavy infections with the fungus *Saprolegnia*. The pathogen *Aeromonas punctata* was isolated from fish blood and dried ulcers and held to be the primary cause. Rohu were particularly severely affected with cephalic lesions. The conditions occurred at the coldest time of the year (about 17°C). Most fish bacterial pathogens are Gram-negative bacteria. This refers to their staining reaction with a diagnostic stain called Gram's stain which is used in microscopy. It is best to use a broad spectrum treatment against Gram-negative bacteria.

A useful general treatment for external lesions is a 30-minute bath in 20 ppm proflavine hemisulphate. If vibrios are suspected, a nifurpirinol (nitrofurazone = furazone) bath for one hour at 10 ppm (active ingredient) is recommended. Mycobacterial gill diseases are best treated with baths of QACs usually for one hour in the range 1-4 ppm active ingredient (details should be sought from suppliers). A 500 ppm copper sulphate dip for 30 seconds to 1 minute is also worth trying if other compounds are unavailable. It is also claimed that the antibiotic kanamycin sulphate is effective against Gram-positive and Gram-negative fish bacterial pathogens including *Aeromonas*, *Vibrio*, *Flexibacter* and mycobacterial infections, by absorption from water or by ingestion/injection. Details should be sought from suppliers for warmwater application.

The most important bacterial diseases of cultured carps are carp erythrodermatitis, columnaris disease and hemorrhagic bacterial septicaemia.

CARP ERYTHRODERMATITIS (CE)

Carp erythrodermatitis is an ulcerative skin condition caused by a widespread bacterium similar to *Aeromonas salmonicida* (the causative agent of furunculosis in salmonids). CE was previously considered part of the infectious carp dropsy syndrome (CE + SCV + SBI). Shallow hemorrhagic ulcers occur on the skin and fins. Mortality is not usually heavy, but severe disfigurement may occur when ulcer scar tissue contracts. In late 1980, a serious epizootic of a bacterial carp disease, with skin ulceration, occurred in West Java, Indonesia. The main causative agent is thought to have been a virulent strain of *Aeromonas* sp.

Treatment is usually by administration of drugs with the feed. A wide range of sulphonamide drugs has been used against this disease: sulfamerazine, sulfaguanadine,

sulfadiazine, sulfamethazine and sulfisoxazole. Most of the literature refers to work with salmonids and/or cold temperatures, but the empirical dose rate of 10 g/45 kg fish/day could be tried for carps in warmwater. Among the antibiotics, terramycin, either incorporated in feeds at 5-7 g/100 kg fish daily for 7-10 days or injected intraperitoneally at 25 mg/kg body weight, has been used successfully.

COLUMNARIS DISEASE

Columnaris disease is a serious infection characterized by lesions usually on the head, back and gills. The causative agent is *Flexibacter columnaris*. The lesions start as small raised whitish plaques, rather fungus-like, often with a reddish peripheral zone and soon develop into large hemorrhagic ulcers. There is very high mortality, especially when the gills are affected. Some strains are highly virulent and produce sudden mortality.

Columnaris disease is often associated with environmental stress, particularly a large rise in water temperature. Unlike most fish disease conditions, outbreaks usually occur only at temperatures above 18 to 20°C.

Treatment of columnaris disease is difficult, but the following have been suggested as possibilities:

1. dipping in 500 ppm copper sulphate for 1-2 minutes;
2. addition of chloromycetin at 5-10 ppm to pond/tank water and
3. if the fish are feeding (which is very rare), incorporation of oxytetracycline antibiotic in the feed at 75 mg/kg of fish/day.

Potassium permanganate addition to pond water to give a final concentration of about 2 ppm may also help. When first applied, this turns the pond water a purple/pink color which gradually fades to straw-brown. When the straw-brown color clears, treatment can be repeated. If 2 ppm is not effective, additional increments of 2 ppm to give final concentrations of 4 ppm, 6 ppm, etc. may be tried. This depends on the water and soil chemistry of the pond and environmental factors.

For addition of compounds to pond water, either make up a stock solution and spray it over the pond (for example, 7.5 kg of potassium permanganate in 230 to 365 liters of water makes a 2-3% solution) or place the compound in a porous bag and tow it from a boat.

HEMORRHAGIC SEPTICAEMIA

Hemorrhagic septicaemia, caused by *Pseudomonas fluorescens*, has been described in silver carp and bighead carp in wintering ponds in Hungary. The fish suffered hemorrhages of the skin, fins, buccal cavity and internal organs and suffered severe anemia and heavy mortality. The disease was not transmitted to common carp kept in the same ponds. This condition has not been described from warmwater ponds.

Treatment is very difficult. Infected fish can be given oxytetracycline in the feed, if they are still feeding. Intraperitoneal injection with antibiotics, for example kanamycin, is also possible for valuable fish.

Protozoan Infestations

ICH, ICHTHYOPHTHIRIASIS OR WHITE SPOT DISEASE

(*ICHTHYOPHTHIRIUS MULTIIFILIS*)

Ich is caused by a common large ciliate protozoan which may reach 0.5 to 1.0 mm diameter. It causes heavy losses in a wide range of cultured fish and can affect all the cultured carps. Its optimum temperature range is 20-24°C, and therefore, serious outbreaks are more likely in temperate/subtropical situations than in the

tropics. Some authors record that infestations do not occur above 20°C, but epizootics have been recorded from Indonesia and Malaysia, especially among fry and fingerlings.

Diseased fish are covered with small white spots which may coalesce as the infection progresses until large areas of dirty white skin are formed. These may fall off. The fins are held close to the body and the fish often show violent swimming movements, presumably because of irritation.

Ich is extremely infectious and develops very rapidly, particularly in intensive recirculation systems and hatcheries. The best treatment is a one-hour bath in 1-2 ppm malachite green plus 167-250 ppm formalin (40% formaldehyde).³ (The lower concentrations are for use in soft, acidic waters where formaldehyde is more toxic.) It is essential when using formalin to ensure that the whitish precipitate (paraformaldehyde), which sometimes forms in stored solutions, is removed by filtration. Paraformaldehyde is extremely toxic to fish. Formalin solutions should be stored in the dark to reduce the rate of paraformaldehyde formation. The combination bath treatment of malachite green and formalin is now widely used against *Ich* and other external protozoan parasites. However, prolonged treatment by maintaining concentrations of malachite green around 0.15 ppm in pond water has also been reported as effective.

COSTIASIS (*ICHTHYOBODO* - *COSTIA NECATRIX*) AND OTHER FLAGELLATE PROTOZOAN INFESTATIONS

Costiasis is caused by *Ichthyobodo*, a small flagellate protozoan parasite of the skin and gills of a wide range of cultured fish, including the carps (although the most serious outbreaks have been described from salmonids). It is an oval or kidney-shaped organism, about 10-15 µm long, with two pairs of unequal flagella held in a groove. The long pair of flagella permits very jerky, free-swimming movements. Severe infestations cause gill congestion and death. Several other flagellate protozoan parasites infest the skin, fins and gills of carps. The most common is *Oodinium* sp. (spherical, about 100 µm diameter).

For treatment, use a formalin bath as described above, a 3-hour exposure to about 100 ppm formalin in concrete tanks or a treatment of about 24 hours with 40 ppm formalin in ponds. Test all treatments on a small sample of fish first.

TRICHODINOSIS AND OTHER CILIATE INFESTATIONS (E.G., THE GENERA TRICHODINA, TRICHODINELLA, CHILODONELLA, GLOSSATELLA AND TRIPARTIELLA)

There is a wide range of peritrich and holotrich ciliate protozoans which can affect carp skin and gills. Multiple infestations are common. The most common and serious are probably the trichodinids. These are easily recognized as spherical (about 40 µm diameter) organisms which look like miniature spiked wheels. *Chilodonella* is a more flattened, ovoid organism up to 70 µm long with rows of cilia. It is a particular problem in overwintering common carp ponds.

The complete diagnosis of such protozoan infestations is often difficult for culturists lacking access to good microscopes and laboratory facilities. However, it is not essential to characterize all the organisms present in an infestation, since formalin bath, tank or pond treatments (see above) can be used for all. Recently, drug companies have been manufacturing a variety of chelated copper compounds which are extremely effective against protozoan parasites, e.g., Copper Control (Argent) and Chelated Copper (Aquavet).

³This means parts per million of 40% formaldehyde. All subsequent references to formalin refer to 40% formaldehyde.

Copper oxychloride has been used as a pond treatment against *Trichodina*, *Chilodonella* and *Ichthyobodo* and is possibly effective against a much wider range of ectoparasites but does not affect *Ichthyophthirus*. In experimental trials, ponds from 0.02 to 2.5 ha were treated successfully with copper oxychloride compounds containing 45% copper (Cobox 50 WP, BASF Akiengesellschaft and Oxicloreto Decobre, Sandoz--Brazil). The chemical was added to the water by buckets to give a concentration of 4-5 ppm. This is about one-twentieth of the concentration at which serious toxic effects to fish are observed. The fish used were 10-90 days old.

MYXOSPORIDIAN PARASITES

Myxobolus and *Henneguya* spp., whose taxonomy is uncertain, have caused heavy losses in Indian major carps, mainly *Catla catla*, in Bangladesh from a condition termed gill myxoboliasis. The evidence is accumulating that such infestations can occur throughout the tropics in a wide range of cyprinids.

Infestations are usually seen as large, white, opaque cysts which may be irregular in shape or spherical and up to around 4 mm across. Earth pond culture helps the parasite's life cycle since spores released from dead (and possibly from living) fish require a period of potentiation in pond mud before they become infective. Myxosporidian infestations are, therefore, very difficult to eradicate from non-drainable ponds. There is no known treatment. Infested fish should be destroyed and burnt or buried. Ponds should be dried and disinfected, as should all facilities and equipment which have had contact with infested fish.

Parasitic Helminths

The literature on fish helminth parasites (monogenetic and digenetic trematodes, nematodes, cestodes and acanthocephalans) is vast. Most infestations are light and do little damage to the host fish. The parasites mentioned here are those which are responsible for serious infestations and which can cause significant damage or mortalities in cultured stocks.

MONOGENETIC TREMATODES

Certain monogenetic skin and gill trematodes (flukes) are among the most serious helminth parasites of cultured carps. The most important genera are the gill flukes *Dactylogyrus* and *Gyrodactylus*. *Dactylogyrus vastator* prefers temperatures above 22°C. *Dactylogyrus* spp. are particularly serious parasites of fry and fingerlings (see below). Infestation of broodfish do occur, however, and can be heavy enough to cause mortality.

A wide variety of chemicals has been tested for dip or pond treatments. The best appear to be Masoten or Nequvon (trichlorphon), a 2- to 3-minute dip in a 1% solution, or Bromex (dimethyl 1, 2-dibromo-2, 2 dichloroethyl phosphate), a prolonged immersion bath or pond treatment at 0.1-0.2 ppm (active ingredient). However, the use of certain chlorinated hydrocarbons and organophosphates is prohibited in some countries because of uncertainty over their biodegradability.

Formalin treatment can also be tried: a 30-minute bath in 200-250 ppm formalin is an approximate starting point for trials. Salt baths with 2.5% NaCl may also be tried against gill flukes, but prolonged immersion must be avoided: common carp usually die after exposure to 3.5% NaCl for 40 minutes, to 2.5% for 60 minutes and 1% for 24 hours.

DIGENETIC TREMATODES

Few digenetic trematodes pose problems for carp culturists. The genus *Sanguinicola* is a blood fluke which is a serious parasite of cultured common carp in

Europe and the USSR and in salmonids in North America. The life cycle involves a gastropod mollusc intermediate host and the adult worms inhabit the fish blood vessels. Acute sanguinicoliasis causes thrombosis and occlusion of gill capillaries by release of the parasites' eggs. In heavy infestations, there can be gill hemorrhaging, necrosis and severe mortality. Chronic low levels of infestation cause nephritis, exophthalmos and loss of condition. There are no known treatments.

The only other problematic parasites are the large numbers of neascid metacercariae which can encyst on carp skin and fins. Metacercarial cysts are seen as small black nodules. The nodules are oval with a wall about 0.8 mm thick encapsulating the metacercaria (0.7-1.4 mm diameter). Heavy infestations may cause debility or death. Metacercariae of the strigeid *Posthodiplostomum cuticola* (*Neascus cuticola*) commonly encyst in cyprinid skin in Europe and North America. The cercariae which invade the skin and form the cysts are shed by the first intermediate host, a planorbid gastropod mollusc, while the final hosts are aquatic piscivorous birds such as herons. It is possible that there are many similar species in the tropics. There are no effective treatments.

NEMATODES

The only well-known problematic nematode parasite for carp culturists is *Philometra lusiana* which infests the scale pockets of common carp in Europe and the USSR. The mature adult female worms are long (up to 16 cm), thin and red in color. Skin ulcers develop in infested fish.

CESTODES AND ACANTHOCEPHALANS

The two species of caryophyllaeid cestodes, *Caryophyllaeus fimbriceps* and *Khawia sinensis* are important in common carp farming and may affect other cyprinids. Both have a seasonal cycle in which the adult worm lives for only one year. New infections occur in late spring/early summer. Eggs shed by adult worms are ingested by tubificid worms in pond mud. Infective stages to fish develop in the tubificid worms in two to three months and carp are re-infested by ingesting them. *Khawia sinensis* is a small worm around 12 mm long and was introduced to Europe from Far Eastern carp farms.

Another cestode which causes serious problems in carp culture is *Bothriocephalus acheilognathi* (= *Bothriocephalus gowkongensis*). In East Germany, this parasite was found in 220 farms with an average rate of infestation of 14.5% of affected fish stocks. The average parasitic burden was 2.6 worms/fish. This parasite occurs in common carp, grass carp and possibly other cyprinids. It is a long pseudophyllidean cestode, up to 20 cm in length and was introduced to Europe with carp from Asia. The life cycle involves a cyclopoid copepod intermediate host. *Bothriocephalus* can affect mainly young fish still feeding on zooplankton in their first summer. Older fish are less affected but often act as carriers.

In caryophyllaeid and *Bothriocephalus* infestations, fish develop hemorrhagic enteritis with destruction of the intestinal epithelium. In heavy infestations, gut perforation can occur. The effects of infestations are usually sublethal; for example, German carp stocks heavily infested with *Bothriocephalus* show a 10% reduction in growth or require 5% more expenditure on feeds to reach market weight than clean stocks. Moreover, consumers often reject infested fish.

The best treatment for cestode infestations is destruction of infested stocks and disinfection of all fish-holding facilities. Quarantine measures are essential. *Bothriocephalus* infestations in East Germany have been reduced by incorporation of an anthelmintic, Zestocarp (active ingredient: niclosamide), also available as Mansonil (Bayer) which, it is said, can reduce infestation by 80-100% especially in warmwater

conditions. However, a recent report by Pool et al. (1984) suggests that praziquantel (Droncit, Bayer) is the best anthelmintic available against *B. acheilognathi*. Infestations were completely eliminated from grass carp at doses between 35 and 100 mg/kg body weight, but this was done by stomach tube feeding under experimental conditions. An alternative measure is to break the life cycle by killing the copepod host with prolonged exposure to 0.25 ppm Dipterex or Masoten (trichlorphon).

Cyprinid species are also known to harbor the plerocercoid larval stages of other cestode genera, such as *Ligula* and *Schistocephalus*, in the peritoneal cavity. These long, white flattish worms are easily recognized. There are no records of serious effects on carp farms and no known treatments.

There are no known important acanthocephalan parasites of cultured carps.

Parasitic Copepods

Parasitic copepods (fish lice) of the genera *Argulus* and *Lernaea* are among the most serious parasites of cultured carps. *Argulus* spp. are widespread in most culture areas. *Argulus* is a small crustacean with a maximum length of 8.5 mm, which perforates fish skin by means of mandibles (fused to a sting-like appendage), its other appendages and a pair of suckers. Infestations may be heavy, up to 400/fish. The parasite causes severe skin damage and anemia and is thought also to facilitate transmission of certain blood-borne diseases (septicaemias).

Argulus species reproduce rapidly in the range 20-28°C. The life cycle takes five weeks (egg to egg) at 25-27°C. Mature *Argulus* leave the fish host to lay eggs on posts and other structures.

Argulus infestations can be treated with a wide range of compounds. Perhaps, the best is Lindane (benzene hexachloride) applied to ponds at 0.02 ppm. Such ponds remain toxic to *Argulus* for up to six days. At 25-27°C, with pH at least 8.0, Lindane is harmless to common carp up to 0.25 ppm. For tank treatments, 0.010 ppm Lindane kills all free-swimming *Argulus* within five hours, whereas 0.013 ppm is needed to kill all attached *Argulus* in the same time period. All concentrations refer to active ingredient. Bronnex (dimethyl-1, 2-dibromo-2, 2-dichlorethyl phosphate) is an alternative to Lindane and is used at 0.1-0.2 ppm (active ingredient) as for monogenetic trematodes (see above).

Lernaea spp., particularly *L. cyprinacea*, are even more serious parasites than *Argulus* spp. Heavy mortalities of carps infested with *Lernaea* have been recorded from Europe, Africa and Asia. *Lernaea cyprinacea* adults are 9-22 mm long and appear more wormlike than crustaceanlike. They have anterior cephalic horns embedded in the host muscle and gill tissue and a long protruding body which bears two prominent egg-sacs in females. Infested fish suffer severe anemia with severe ulcerations around parasitic lesions, and mortality can occur with heavy infestation. Consumer rejection of infested fish is a major problem.

The literature on treatment of *Lernaea* infestations is confusing. Sodium chloride baths and potassium permanganate treatments have been used with some success, but the margin of error between killing the parasite and killing the fish may be fairly narrow. Moreover, potassium permanganate affects particularly the adult *Lernaea* and may not eradicate all juvenile stages embedded in the skin. Even 8 ppm potassium permanganate in ponds only kills 75-90% of adult parasites. Therefore, recent methods have centered on the use of chemicals such as Dipterex and Bromex to kill the copepodid free swimming stages as well as the adults. Dipterex at 0.25 ppm active ingredient kills copepodid larval stages within four to six hours. However, the naupliar stages may be resistant. Bromex is preferable since it kills all stages of the life cycle. Ponds should be sprayed to give a concentration of 0.12 to 0.15 ppm

Bromex (active ingredient). This is completely safe for carps since the LC_{100} for Bromex toxicity to common carp is 3.0 ppm for 1-2 g carp fingerlings and 8.6 ppm for adult fish (> 50 g). Again, the comments given above about regulations on the use of pesticides should be borne in mind. It is to be hoped that new drugs will be developed against this important parasite.

Other Diseases and Abnormal Conditions

The standard textbooks on fish diseases and pathology describe a wide range of other microbial pathogens, parasites and abnormal conditions of cultured fish including many reports on carps. These include neoplasia (tumors) of various origins, nutritional deficiency syndromes, toxicoses (especially from aflatoxins in feeds) and the effects of various parasites and predators. These will not be described here as they form a very lengthy catalogue and diagnosis is often difficult. Many of these conditions become apparent when fish show clinical signs typical of the diseases described above, such as loss of appetite, melanosis (darkening), exophthalmos, gill and fin rot and death. Among the metazoan parasites which can affect carps, one group deserves special mention since it is not included in any of the above sections. The glochidial larval stages of some species of freshwater bivalve molluscs are parasitic on the gills of fishes. The glochidia of *Anodonta woodiana* infest fish gills in Indonesia. Leeches are also known to affect carps. The leech *Piscicola geometra* is a well-known parasite of common carp and a single 2-4 cm individual can gorge itself on blood within about 48 hours, taking in about 150 ml. The parasite may then leave the fish or remain attached and continue biting the skin. *Piscicola geometra* is known to transmit the blood protozoan parasite *Cryptobia cyprini* (which is thought to cause anemia and capillary obstruction) in addition to the skin wounds and ulceration caused by the leech bites. The only effective control is by liming drained ponds.

PARTICULAR DISEASE PROBLEMS OF EGGS, HATCHLINGS, POSTLARVAE, FRY AND FINGERLINGS

The early life history stages of carps are, like those of other fish, particularly susceptible to diseases. The most serious diseases of eggs are caused by fungal infections with *Saprolegnia* and *Achlya* species. They can easily be controlled by malachite green flushes. A concentration of around 2 ppm for one hour is a good control measure (prophylaxis) during incubation.

Hatchlings, postlarvae and fry are the most susceptible stages to microbial diseases and parasitic infestations. Severe mortalities among carp fry have been recorded in many Asian countries from the following: *Ich* disease, *Trichodina* spp., *Myxobolus* spp., *Ichthyobodo* spp., *Lernaea cyprinacea*, *Lernaea piscinae* (in bighead), *Argulus* spp. and *Dactylogyrus* spp. For example, *Lernaea cyprinacea*, introduced to Indonesia from Japan in 1953, caused serious epizootics in common carp and other fish which destroyed 30% of the hatchery production in Java, north Sumatra and north Sulawesi. About 1.5 billion fry were lost. *Dactylogyrus vastator* can infest carp fry within 5 to 10 days of hatching and has caused losses as high as 5 million/year in Israel (15-20% of the annual national requirement).

The same diseases can cause serious losses in fingerlings. For example, a myxosporidian fin infection of common carp fingerlings (*Thelohanellus* spp.) is widespread in Hungary. In late 1980, an epizootic caused by *Myxobolus* sp. caused serious fingerling losses in West Java, Indonesia.

When attempting to treat hatchlings, postlarvae, fry and fingerlings, it is extremely important to try out the treatment first on a small sample and to assess recovery. All these stages are far less tolerant of the toxic effects of chemical treatments than are adult fish.

Hatchlings, postlarvae and fry are also sometimes affected by what is called gas bubble disease. This occurs when hatchery water is supersaturated with dissolved gases (nitrogen and oxygen) which come out of solution in various fish tissues and are seen as small gas bubbles. These have a tendency to accumulate in loose connective tissue, especially around the eyeballs giving a condition known as pop-eye. Gas supersaturation of hatchery water is often associated with ground water supply or water kept in large closed containers and long pipe-runs. Pipes with some porosity or small air leaks increase the problem. The condition can cause massive deformities and mortalities. The best solution is to using de-gassing devices such as a series of troughs arranged so that water cascades from one to the other before reaching the hatchery tanks or plastic net sleeves and sprinkler devices, again before the larval rearing tanks. These also help with temperature equilibration.

Quarantine Measures

The need for fish quarantine measures is thoroughly discussed in the 1983 publication of the International Development Research Centre, Canada: *Fish Quarantine and Fish Diseases of Southeast Asia—Report of a Workshop Held in Jakarta, Indonesia, 7-10 December 1982*. Many serious diseases have been transferred between countries due to inadequate quarantine measures. Introductions of *Ichthyophthirius* (1932), *Lernaea* (1953) and *Myxobolus* (1978) to Indonesia are well documented. At present, however, only Indonesia and Singapore among the ASEAN nations are experimenting with quarantine procedures for fish importations.

Quarantine measures and the promulgation and enforcement of legislation are complex and difficult. In Asia particularly, most countries need to document the diseases already found within their borders, upgrade their systems of diagnosis, inspection and disease control and train more expert staff to enforce relevant legislation. One major lack is the absence of expertise in fish virology in most developing countries. The Regional Centre for Tropical Biology (BIOTROP), Bogor, Indonesia is holding annual fish disease training courses from 1983 to 1988. Obviously much upgrading of facilities and staff capabilities is required to operate efficient quarantine systems.

No entire living fish can ever be given a completely clean bill of health. Even very healthy-looking fish may be carrying viruses or other micropathogens. However, quarantine measures are an essential means of controlling the spread of disease.

AN EXAMPLE OF FISH QUARANTINE PROCEDURES IN ASIA

The following account is taken from the Indonesian country report in IDRC's (1983) summary of current methods in use in Jakarta, Indonesia. These are likely to be amended/finalized in the near future. This section is included here as an *example* of the procedures required for quarantine and *not* as an exact formula for adoption in other situations.

By Decree D.V. 7819/c/10/75,

- all live fish must be accompanied by a health certificate issued by the Governor of Jakarta;
- all fish must be quarantined during inspection;
- if dangerous (prohibited) species are found in the consignment, they must be seized as government property and destroyed or used for research purposes;
- if the fish are suffering from communicable diseases, they must be treated before being released. If the disease is impossible to treat effectively, the fish must be destroyed.

Importers and exporters not complying with this decree are subject to penalty. Would-be importers must request a permit (with quantity of fish and time limits specified) from Jakarta's fisheries service which passes the request to the Directorate General of Fisheries (DGF) for approval. If the DGF approves the request, the fish are placed in quarantine for at least two weeks, and samples are examined at the Inland Fisheries Research Institute (IFRI) laboratory. Imports of live fish must be accompanied by the special permit issued by DGF, and international trade is allowed only through the Airport of Halim Perdana Kusuma, Jakarta, where arriving and departing fish are inspected.

Fish are dispatched only after being declared free of parasitic and bacterial disease, for which a health certificate is issued by the fish quarantine station.

The IFRI accepted the responsibility for conducting post-entry quarantine services at Pasar Minggu, Jakarta, and provides a diagnostic laboratory, fish-holding equipment and personnel for disease examination. Two fish pathologists from IFRI are involved in these quarantine activities, and they carry out the gross pathological examinations as well as the parasitological, bacteriological, and histopathological examinations, using standard procedures. The fish are held in isolation tanks and aquaria for a minimum of two weeks, after which they are released if they have not exhibited signs of disease. During quarantine, the physical, behavioral and clinical manifestations of disease are observed. The fish, if necessary, are treated with chemicals and antibiotics, such as potassium permanganate, formalin, malachite green and terramycin (Table 9.1). The methods of treatment include immersion (dipping, short bathing for 1 hour and long bathing for 6 to 24 hours), systematic treatment (injections and feeding with antibiotics) and swabbing. Immersion may be repeated 2 to 3 times at 3-day intervals (shorter intervals cause undue stress).

Table 9.1. Procedures used in the identification and treatment of fish diseases found during quarantine (2 weeks-1 month) at Pasar Minggu, Jakarta, Indonesia.^a

Disease agent	Method of examination	Treatment
1. Protozoa		
Ichthyophthirius	Microscopy	Bathe (12-24 hours) in malachite green (0.1 ppm) and formalin (25 ppm).
Trichodina	Microscopy	Bathe (1 hour) in formalin (0.25-0.33 ppt).
Costia (Ichthyobodo)	Microscopy	Bathe (1 hour) in formalin (0.25-0.33 ppt).
Myxobolus	Microscopy	Destroy fish carrying the parasite; increase quarantine time for those suspected of being infested.
Thelchanellus	Microscopy	Destroy fish carrying the parasite; increase quarantine time for those suspected of being infested.
Henneguya	Microscopy	Destroy fish carrying the parasite; increase quarantine time for those suspected of being infested.
2. Parasitic crustaceans		
Lernæa	Microscopy	Bathe in organophosphates (0.1 ppm) for duration of quarantine or dip in organophosphates (1%) for 2-3 minutes.
Gyrodactylus	Microscopy	Bathe in organophosphates (0.1 ppm) for the duration of quarantine or dip in formalin (1%) for 2-3 minutes.
Dactylogyrus	Microscopy	Destroy fish carrying the parasite; increase quarantine time for those suspected of being infested.

Continued

Table 9.1. (continued)

Disease agent	Method of examination	Treatment
3. Fungi		
Saprolegnia	Microscopy	Dip (1 minute) or bathe (1 hour) in malachite green (67 ppm or 1-2 ppm, respectively) or swab lesions directly with malachite green (1%).
Achlya	Microscopy	Dip (1 minute) or bathe (1 hour) in malachite green (67 ppm or 1-2 ppm, respectively) or swab lesions directly with malachite green (1%).
Branchiomyces	Microscopy	Destroy fish carrying fungus; increase quarantine time for those suspected of being infested.
4. Bacteria		
Aeromonas	Culture	External infection: bathe (0.5 hour) in KMnO_4 (15-20 ppm); systemic infection: incorporate daily into food (g/day, 50 kg body weight) conventional sulphonamides (5-10 g) nitrofurans (5 g) potentiated sulphonamides (2.5 g) or antibiotics (3.5 g) for 10 days).
Pseudomonas	Culture	External infection: bathe (0.5 hour) in KMnO_4 (15-20 ppm); systemic infection: incorporate daily into food (g/day, 50 kg body weight) conventional sulphonamides (5-10 g) nitrofurans (5 g) potentiated sulphonamides (2.5 g) or antibiotics (3.5 g) for 10 days).
Mycobacteria	Culture	External infection: bathe (0.5 hour) in KMnO_4 (15-20 ppm); systemic infection: incorporate daily into food (g/day, 50 kg body weight) conventional sulphonamides (5-10 g); nitrofurans (5 g); potentiated sulphonamides (2.5 g); or antibiotics (3.5 g) for 10 days).
Columnaris (Chondrococcus)	Culture	External infection: bathe (0.5 hour) in KMnO_4 (15-20 ppm); systemic infection: incorporate daily into food (g/day, 50 kg body weight) conventional sulphonamides (5-10 g) nitrofurans (5 g) potentiated sulphonamides (2.5 g) or antibiotics (3.5 g) for 10 days.
Flexibacter	Culture	External infection: bathe (0.5 hour) in KMnO_4 (15-20 ppm); systemic infection: incorporate daily into food (g/day, 50 kg body weight) conventional sulphonamides (5-10 g) nitrofurans (5 g); potentiated sulphonamides (2.5 g) or antibiotics (3.5 g) for 10 days.
Mycobacteria	Culture	Bathe (1 hour) or dip (1 minute) in furanace (0.5 ppt) or CuSO_4 (0.5 ppt).
5. Known diseases		
Spring viraemia of carp	Clinical signs	Destroy fish exhibiting symptoms; increase quarantine time for those suspected.
Infectious dropsy	Clinical signs	Destroy fish exhibiting symptoms; increase quarantine time for those suspected.
Swim bladder inflammation	Clinical signs	Destroy fish exhibiting symptoms; increase quarantine time for those suspected.

^aCondensed from IDRC (1983).

In summary, fish quarantine activities include:

- fish identification;
- fish disease identification;
- treatment and disinfection of fish for which diseases or parasites are detected;
- plastic bags or holding containers for fish transportation are carefully disinfected or are destroyed.

Quarantine stations must be established close to ports of entry on sites isolated and far from fish culture areas. Effluents must not reach public waters but must be thoroughly disinfected and released through an underground septic system.

QUARANTINE MEASURES FOR THE FARMER WHEN INTRODUCING NEW FISH

When introducing new fish to a farm or hatchery, it is advisable to use quarantine procedures to isolate them from existing stocks. Quarantine is best accomplished in small tanks. The Indonesian facility referred to above recommends concrete or

fiberglass tanks, 0.4 to 1.0 m wide x 1.0 x 2.0 m long (for small fish in small numbers) or tanks of up to 20 m³ capacity for larger holdings. Each tank must have an independent water supply and drainage. For very large numbers/weights of fish, large isolation ponds can be used. These should be remote from production ponds, drainable and with independent water supply and drainage.

For all quarantine measures, it is essential that effluents be disinfected and discharged through underground septic systems. On no account should untreated effluents reach production ponds or natural watercourses.

Guidelines for Health Certification of Broodstock Used for High Quality Seed Supply

This section summarizes the type of rigorous testing of broodstock required for meaningful health certification. The procedures outlined are taken from those in use in the United Kingdom for health certification of salmonid broodstocks at hatcheries which sell ova to domestic and export markets (MAFF, n.d.). To the best of the authors' knowledge, such testing is not yet performed on any carp broodstock in the tropics. It would be very expensive and unnecessary for these procedures to be adopted by large numbers of production hatcheries. However, it would be very desirable for one or a few such well-certified broodstocks to be maintained in each country with interests in carp culture to act as centers for distribution of high quality disease-free seed. Such seed is very valuable for example, to restock farms after disease outbreaks and to effect introductions of carps to new areas where they have not previously been cultured. Moreover, the procedures outlined here give a method for sampling broodstock for the detection of disease-carriers which can be applied in any situation where certification against one or a few pathogens or parasites is required.

All fish being held as broodstock for certification purposes, should ideally be kept in nonporous ponds fed by a protected water supply from a spring source or from a bore-hole. The broodstock should at all times be kept isolated from other fish stocks. On no account must fish be introduced into the water supplying a broodstock pond once testing for certification purposes has been initiated. All broodstock must be tested at six monthly intervals for two years by the procedure described below. One test in each year must always be made on the broodstock at spawning time.

A pre-determined number of fish needs to be sampled from each broodstock on the farm. Where broodstocks are held in ponds supplied with water from different sources (e.g., river, spring, bore-hole), the tests must be carried out on representative samples of the fish from *each* kind of water supply. Since it is not practicable to test every fish in a population, it is necessary to use a sampling procedure, details of which are outlined below.

The sampled fish are tested in batches of five. Table 9.2 shows the number of fish which must be sampled in populations of various sizes to give a 95% confidence level of detecting a disease with an assumed minimum incidence of infection of 2%. With a disease incidence of only 2%, the number of infected fish occurring in a very small population will clearly be very low. In such situations, it becomes necessary to take most of the populations as the sample in order to ensure 95% confidence that at least one of the infected fish is in the sample. On the other hand, at very large population numbers, no increase in accuracy at the 95% confidence level is obtained by the sample being larger than 150 fish. As the testing procedure provides for batches of 5 fish at a time to be pooled for test, the sample sizes in the second column have been rounded upward, as shown in column three, to provide for this.

Table 9.2. Sample sizes for various fish population sizes (from hypergeometric and Poisson probability distributions) (95% confidence level).

Number of fish in population	Number of fish required in sample at 2% infection level of the population	Number of fish required to make up pooled samples of 5 fish each
50	40	5 x 10 = 50
100	76	5 x 16 = 80
250	110	5 x 22 = 110
500	127	5 x 26 = 130
1,000	136	5 x 28 = 140
2,500	142	5 x 29 = 145
5,000	145	5 x 29 = 145
10,000	146	5 x 30 = 150
100,000	147	5 x 30 = 150
over 1,000,000	150	5 x 30 = 150

For intermediate population sizes to those shown in column one, the sample size in the next higher population listed must be used. The figures given are the minimum necessary to constitute a representative sample for the purposes of certification.

Diagnostic Procedures

PRELIMINARY EXAMINATION

Prior to laboratory examination, the fish population must be subjected to a thorough visual examination for external signs of disease. Any fish showing evidence of disease must be included in the samples taken for laboratory examination. Carp erythrodermatitis can be detected by visual examination, since its typical skin ulcers are easily recognized. Infected fish may be recognized by the presence of one or more skin ulcers of varying sizes, chiefly confined to the body flanks. These ulcers begin as small areas of skin inflammation or small white erosions encircled by a narrow red zone and intense pigmentation. Subsequent enlargement of the central necrotic area and surrounding inflammation results in the formation of large and often deep ulcers which may contain pus. Although often circular, the shape of the lesions can vary with location on the fish. Badly affected fish may also exhibit a distended abdomen and exophthalmos.

LABORATORY TESTS

For diagnostic and detection procedures, refer to Table 9.1. The additional information given here refers to tests for viruses. There are very few laboratories able to test for viruses within the tropics and subtropics. At present only spring viraemia (SV) is well-known as a viral pathogen of carp (see above) and is not a problem in the tropics and subtropics. However, more viral pathogens may well be discovered in the future, and therefore, this account of testing procedures for SV is useful in that it shows the capabilities required.

Tests for the presence of SV virus must be made at a time when the water temperature is rising from the low winter temperatures to the higher summer temperatures since the level of virus in the tissues increases at this time. A second test in the year must be carried out on ovarian fluid at spawning time.

For maximum sensitivity, all samples should be tested within a few hours of collection and in all cases, samples must be tested within 24 hours, during which, storage must be at 4°C. Tests on broodstock can be planned well in advance, so

storage of material for longer periods should not be necessary. On no account must samples taken from broodstock be frozen before testing.

Pooled viscera (from 5 fish, see above), kidneys, livers and spleens should be mixed with an equal volume of Hanks Saline or Earle's Balanced Salt Solution and homogenized in the usual laboratory homogenizers, or with a mortar and pestle. Pooled ovarian fluid must be mixed well and the fluid decanted from any eggs present. All extracts and ovarian fluid should be centrifuged at 1,000-2,000 "g" for 15 minutes and the supernatant collected. Except in the case of ovarian fluid, which must remain undiluted, the supernatant should then be diluted a further 1/10 in HS or BSS.

Bacteria must be removed by filtration through a 0.22 μ m membrane filter or by adding the antibiotics penicillin, streptomycin and nystatin to the diluted supernatant or ovarian fluid at a rate of 1,000 I.U. per ml, 1,000 μ g per ml and 500 I.U. per ml, respectively. If antibiotics are used, samples should then be incubated at 20°C for three to five hours. Antibiotic use can give a greater chance of detecting low levels of virus since it eliminates the possibility of retaining virus on the filters. However, when this technique is to be used it is recommended that the collection and extraction of tissues should be carried out with aseptic techniques. When the material under test is feces not viscera (e.g., as for IPN virus testing in trout), it is more reliable to use the filtration method for the elimination of bacteria. Bacteria-free extracts of viscera or ovarian fluid should be inoculated onto fathead minnow (FHM) cell cultures.

Rainbow trout gonad (RTG2) cells have low susceptibility to SV virus and must not be used in this test. FHM cell lines are available from major biological supply houses. Only young, actively growing cultures, i.e., one to four days old and 75-90% confluent, should be used for the isolation tests. FHM cells should be grown at 25-29°C. It has been reported from several laboratories that some fish cell lines appear periodically to lose their receptivity to some fish viruses. At the time of testing, therefore, the susceptibility of the cell cultures being used should be checked by inoculation of at least two duplicate control tubes with a known infective dose of the virus under test.

Duplicate tubes or flasks of FHM cells should be inoculated with each filtered or antibiotic-treated extract or fluid at a rate of 1/10 the normal maintenance medium volume. Thus, there will be two inoculated cultures per five pooled fish. An absorption period of one hour should be allowed and after that the normal volume of maintenance medium should be added. The cultures should then be incubated at 15-22°C with pH maintained at 7.4 to 7.6 and examined daily for signs of cytopathic effect (CPE).

If a viral-type CPE develops, the virus identity should be confirmed by serological neutralization with SV antiserum. At the present time, there is no evidence for more than one serotype of SV. If no CPE develops after 10 days, the cultures should be harvested and passed undiluted onto fresh tissue cultures. If CPE develops within the first 10 days, the cultures should be harvested, diluted 1/5, filtered through a 0.22 μ m membrane filter and inoculated onto fresh tissue cultures. If no CPE develops during the second incubation period of 10 days, the test can be declared negative. If viral-type CPE develops during the second incubation period the virus must be identified by serological neutralization.

Chapter 10

Specialized Scientific Equipment and Implements¹

Specialized equipment essential for the following fish hatchery operations and needs is listed in this Chapter. A complete list is given for each operation and is somewhat repetitive since some activities require the same equipment. A hatchery ought to possess all equipment items in adequate numbers so that they can be gathered and kept handy for an operation without hampering certain other activities which, under exigency of circumstances, may have to be simultaneously done by different workers. The operations and equipment are as follows:

- A. Collection and transport of broodfish
- B. Collection, preservation and storage of pituitary glands and hypophysation
- C. Stripping broodfish and artificial fertilization
- D. Incubation, postlarval nursing and fry rearing
- E. Rearing and transport of postlarvae, fry and fingerlings
- F. Miscellaneous laboratory apparatus and field equipment
- G. Chemicals

The "Buyer's Guide", published annually by Aquaculture Magazine, P.O. Box 2239, Asheville, North Carolina 28802, U.S.A., is a comprehensive guide to all categories of equipment listed below. An alternative source is the European Aquaculture Trade Directory published by the European Aquaculture Society, Prinses Elisabethlaan 69, B-8401, Bredene, Belgium.

- A. COLLECTION AND TRANSPORT OF BROODFISH
 1. Nylon seine netting pieces 25- and 40-mm meshed (knot to knot diagonally stretched) of dimensions 5 m x 2.5 m, with sinkers and floats such that when joined, a total length up to 25 m and width of 2.5 m of nets of each mesh size can be rigged up for capture of broodfish
 2. Nylon scoop nets of 25-mm meshes open at both ends with 2.5-m long handle (to pick up broodfish from the seine)
 3. Canvas hammocks or stretchers with removable burlap or net cover with projected handles at both ends (for short distance transport of large broodfish individually) (see Fig. 6.3, p. 76)
 4. Canvas satchels (for transporting smaller broodfish over short distances)
 5. Fiberglass or low density polyethylene (LDPE) tanks of circular or rectangular shape to hold broodfish for anesthetizing, 100-, 250- and 500-l capacity

¹It is presumed that a well-designed fish farm with ponds for different operations, a hatchery proper with breeding, hatching and storage tanks, infrastructural facilities for high quality water supply and a laboratory equipped with basic chemical hardware are available for the use of workers.

6. Live fish transport vehicle with facility for circulating water (of high dissolved oxygen content and thermostatically controlled temperature) for long distance transport of broodfish (see Fig. 6.6, p. 78)
7. Spring balances 1-, 2-, 5-, 10-, 20-kg capacities for weighing broodfish
8. Cheesecloth for holding broodfish
9. Anesthetizing chemicals (see p. 78-79)
10. Plastic buckets with lids, 1-, 2-, 4-, 8-, 12-l capacities
11. Cotton wool

B. COLLECTION, PRESERVATION AND STORAGE OF PITUITARY GLANDS AND HYPOPHYSATION

1. Electric drill with 2.5-3.0 cm diameter keyhole-saw for drilling into fish skull
2. Crosscut saw for sawing through fish skull
3. Fish measuring board of 1-m length graduated in mm
4. Beam balance with weights (to weigh up to 25 kg)
5. Fine forceps for lifting pituitary glands
6. Pure acetone
7. Desiccators with silica gel or other desiccant
8. Disposable and/or reusable hypodermic syringes of 1-, 2-, 5- and 10-ml capacities with spare needles of appropriate size and gauge
9. Porcelain pestle and mortar (5-7 cm top diameter) for pulverizing and grinding pituitary glands
10. Glass homogenizer tube with matching glass rod pestle
11. Widemouthed bottles with glass stoppers of 100 ml capacity
12. Hand centrifuge with graduated tubes and spare tubes
13. Small electric bench centrifuge with speed control
14. Ethyl alcohol for disinfecting reusable syringes and needles after use
15. Fish tagging gun with numbered and/or color-coded tags for tagging broodfish
16. Strong cobbler's needles and strong cotton thread and pliers for genital suturing of common carp female broodfish (if suturing practiced)
17. Cotton wool and anesthetizing bags (for putting in broodfish mouth or gill chamber after soaking in anesthetics of correct strength)
18. Graduated measuring cylinders of different graded capacities
19. Graded wideneck bottles with glass stoppers
20. Rubber-foam mats 60 cm x 40 cm of 2.5-cm thickness, folding tables, for keeping broodfish while injecting and folding chairs
21. Cheesecloth for holding broodfish while injecting
22. Balance for weighing chemicals (electric or mechanical)
23. Electric analytical balance for weighing pituitary glands (accurate to 0.1 mg)
24. Distilled water
25. Anesthetizing chemicals (see p. 78-79)
26. Widemouthed vacuum flasks of 1- and 2-l capacities for transporting hormones in ice

C. FERTILIZATION AND STRIPPING

1. Plastic or enamel basins of 2-, 3-, 5-l capacities for stripping
2. Graduated plastic buckets of 8-, 10-, 12-l capacities
3. Cheesecloth for holding live fish while stripping
4. Catheters of 2.5-mm diameter for withdrawing samples of oocytes

5. Milt collection syringes
6. Dry and strong feathers for artificial fertilization in plastic or enamel basins
7. Assorted graduated plastic mugs with handles
8. Beam balance with weights of 10-kg capacity graduated in grams for weighing fish eggs and egg samples
9. Spring balances of 1-, 2-, 5-, 10 and 20-kg capacities with 5-, 10- and 25-g graduations depending on capacity
10. Assorted plastic bottles with stoppers
11. Folding work tables and chairs of noncorrosive materials
12. Fish measuring board of 1-m length graduated in mm
13. Scoop nets of 2.5-cm mesh with both ends open and 1-m long handles
14. Dip nets of muslin or organdie with 1-m long handles
15. Portable fiberglass or low density polyethylene (LDPE) material of 100-200-l capacity round or rectangular tanks
16. Dissecting instrument set
17. Assorted funnels for filtration purposes
18. Filter papers

D. INCUBATION, POSTLARVAL NURSING AND FRY REARING

1. Rubber or plastic tubing of assorted diameters
2. Dip nets of muslin or organdie with arrangement for attaching collection specimen tube (like a plankton net)
3. Petri dishes of assorted sizes
4. Glass cavity blocks of assorted sizes
5. Watch glasses of assorted sizes
6. Graduated plastic mugs of assorted sizes with handles
7. Graduated plastic buckets of assorted sizes
8. Thermometers (0-50° C range)
9. Dissection microscope with stage lighting lamp
10. Stereo-microscope with lamp for stage lighting
11. Electric stoves and pans of assorted sizes (for boiled egg and other preparations)
12. Electric grinder, mixer and blender for making microencapsulated chicken egg diet and grinding and mixing dry fish feeds
13. Brushes of assorted sizes for cleaning incubators
14. Brushes for scrubbing and cleaning basins
15. Dissection set
16. Glass beakers of assorted sizes
17. Dry cell operated powerful flashlights
18. Powerful compressor or blower with conduits, bifurcating and trifurcating joints, tubing such that air can be bubbled through tubs, basins, pools, jars, etc., as necessary
19. Diffusers of assorted sizes to be used for aeration
20. Generator of moderate capacity as a standby for producing electricity sufficient for lighting, aeration, emergency pumping and refrigeration units

E. TRANSPORT OF POSTLARVAE, FRY AND FINGERLINGS

1. Oxygen cylinder with pressure gauge and reduction valve
2. A large number of plastic bags of 0.3-0.5 mm gauge of circumference 100-150 cm and height 65-75 cm and/or equivalent polyethylene sleeving for making bags

3. Strong twine for leakproof tying of plastic bags
4. Scoop nets of mesh (0.5-1.0 cm) open at both ends
5. Plastic buckets of assorted sizes

F. MISCELLANEOUS LABORATORY APPARATUS AND FIELD EQUIPMENT

A range of analytical, measuring and sampling equipment is listed since the needs of individual establishments will vary greatly. Many sources of supply exist in different countries. Comprehensive lists appear in the Aquaculture Magazine Buyer's Guide and the European Aquaculture Trade Directory. See p. 133.

1. Kemmerer water sampling bottle (for drawing water samples from desired depths)
2. Secchi disc (see Chapter 5)
3. Sedgwick-Rafter Plankton Counting Cell (1-ml capacity) with cover slips
4. Micro-biological pipettes, 1-ml capacity or medicine droppers calibrated to deliver 1.0 ml
5. Microscope with a mechanical lighted stage and micrometer accessories for measuring specimens
6. Bolting silk plankton nets of different mesh sizes for plankton collection
7. Electric analytical balance for weighing chemicals, accurate to ± 0.001 g
8. Electric top-loading balance; accurate to 0.05 g, range about 0-2 kg
9. Balances for field use, e.g., triple-beam mechanical balance, spring balances
10. Small bench spectrophotometer (e.g., Bausch and Lomb)
11. Portable dissolved oxygen meter and Winkler titration equipment
12. Portable pH meter
13. Water analysis kit (e.g., Hach)
14. Biochemical oxygen demand apparatus
15. Soil auger for soil sampling
16. Pond bottom soil grab sampler with rope and messenger arrangement
17. Microscope slides and cover slips
18. Specimen jars and tubes

G. GENERAL EQUIPMENT

1. Pick-up or delivery vans
2. Cars for movement of staff
3. Live-fish transport vehicle (see Fig 6.6, p. 78)
4. Twelve-volt DC battery-operated aerators with tubing, terminal fixers, alligator clamps and diffusers
5. Glass aquaria
6. Blowers or compressors for aeration
7. Reagent bottles
8. Distilled water apparatus
9. Wall clocks
10. Data filing and processing equipment, e.g., hand calculators; microcomputers
11. Refrigerators
12. Deep freezers
13. Tool kits for workshop
14. Storage batteries, 12-volt heavy duty
15. Towels and napkins
16. Shovels, spades, rakes and other farm implements and tools
17. Cylindroconical and circular fiberglass tanks and pools of about 1 m³ capacity

18. Vermin-proof storage bins for organic fertilizers (e.g., dried manures, compost) and fish feeds
19. Lockable poison cabinet
20. Standby generator

H. TRAINING AND DEMONSTRATION EQUIPMENT

1. Thirty-five-mm single lens reflex camera with macro lens and flash
2. Movie film projector, 16 mm and sound track
3. Slide projector, 35 mm
4. Slide viewer
5. Video recorder/cassette player
6. Overhead projector

I. CHEMICALS AND APPLICATORS

1. Formaldehyde (commercial "formalin")
2. Tannic acid
3. Urea
4. Sodium chloride (domestic salt is acceptable grade)
5. Malachite green (zinc-free)
6. Copper sulphate
7. Potassium permanganate
8. Copper oxychloride
9. Absolute ethyl alcohol, acetone
10. Organophosphate pesticides, e.g., Sumithion 50 EC (Snell) and Dipterex (Bayer) (see p. 68)
11. Induced spawning compounds, choices according to species/circumstances: dried carp pituitary powder; salmon gonadotropin (Syndel); human chorionic gonadotropin; luteinizing hormone-releasing-hormone analogues (e.g., LHRH-A, Shanghai Institute of Biochemistry; Hoe 765, Hoechst with progesterone; LHRH-A (Syndel) with pimozide)
12. Acetic acid (glacial)
13. Hydrochloric acid
14. Quick lime, calcium hydroxide
15. Sulphuric acid
16. Sodium hydroxide
17. Anesthetics, e.g., quinaldine, MS 222 (Sandoz), 2-phenoxyethanol
18. Rotenone
19. Rat poison
20. Two, 4-dichlorophenoxy acetic acid (2-, 4-D) or Taticide-80 (2-, 4-D sodium salt 80%) (see p. 70)
21. Poultry manure (dried)
22. N P K fertilizers (see p. 66) and/or additional inorganic fertilizers, e.g., sodium nitrate; triple superphosphate; muriate of potash (potassium chloride)
23. Ammonia gas cylinder
24. Oxygen cylinder with pressure gauge and reduction valve
25. Knapsac sprayers
26. Domestic detergents
27. Agricultural disinfectants, e.g., sodium hypochlorite; iodophore compounds (see p. 117-118)
28. Desiccators with silica gel

Applied Research Problems and Personnel Requirements

Attention has been drawn in the Introductory Chapter of this Manual to the present empirical and imprecise status of aquaculture as a science. There are two aspects in which the level of science in aquaculture can be elevated such that the contribution the discipline can make in raising fish yields per unit of area and time can be rationalized and maximized. The first aspect deals with problems of local site-specific nature, such as the best yield under a given agro-climatic regime utilizing present day knowledge and additional relevant knowledge of the subjects. The second deals with the possibility of a quantum jump in production through basic research, such as genetic improvement of stocks, and development of innovative controlled breeding or growth-promoting methods. For any advances, well-equipped laboratories and farms are essential.

For basic research, however, more specialized and sophisticated scientific instruments and well trained technical personnel for their proper use and interpretation of data are required. It is perhaps proper that each country, depending on its size and diversity of soil type, water resources and climate, has at least one fully equipped research hatchery with specialized and sophisticated instruments and adequately trained scientific personnel. Additionally, every hatchery in a country should have at least a minimum of equipment for its essential operational needs. Moreover every hatchery should be able to carry out, within its overall mandate, certain elements of investigation rather than follow empirical and inexact methods.

In this Chapter are initially listed subject-wise, the more important problems of applied research and their objectives, and later, the manpower required for effectively operating a carp hatchery. Research should be done on every species covered in this Manual. The subjects dealt with for research are:

- I. Biology and Genetics
 - A. Studies on Riverine Stocks of Fish
 - B. Studies on Farm Grown Fish
 - C. Genetical Selection and Hybridization
- II. Hatchery Engineering
- III. Broodfish Husbandry
- IV. Larval Rearing
 - A. Water Quality
 - B. Soil Quality
 - C. Postlarval Nursing
 - D. Fry Rearing
- V. Hatchery Management

The starting point for a well-informed worker on every subject is present knowledge and the means to gather it, for which a hatchery essentially needs a

library of its own. The library has to have a minimum of essential books and literature and should, if possible, subscribe to certain periodicals for keeping the workers posted with advances in knowledge. The references and additional reading lists provided with this Manual are a good starting point.

I. Biology and Genetics

Judging from research results in agriculture, horticulture, livestock and fish so far attained, it is anticipated that the most far-reaching developments in aquaculture for raising yields per hectare and per unit of time lie basically in stock improvements through genetics research. It is necessary that carp genetic resources of the world be properly recorded and conserved to serve as sources of valuable material for stock improvements. The wild types available in different river systems are all potentially important. Also important is knowledge of the culture performance in respect of disease resistance, growth rates, conversion ratios, dressing weight ratios, size and age at first maturity and fecundity with different feeds under culture conditions for wild and cultured strains.

A. STUDIES ON RIVERINE STOCKS OF FISH

1. Ratios and correlations of morphometric measurements between the body parts of fish (as usually done in racial studies based on morphometry)
2. Comparative meristic studies, e.g., fin ray, vertebral and gill-raker counts
3. Electrophoretic marker studies
4. Growth rate
5. Length-weight relationships for both sexes
6. Dressing weight ratio
7. Size and age at first maturity
8. Fecundity at different ages/sizes

B. STUDIES ON FARM GROWN FISH

1. Conversion ratios with different feeds
2. Growth rates with different feeds
3. Length-weight relationships for both sexes
4. Size and age at first maturity
5. Fecundity at different ages/sizes
6. Total fecundity during entire lifespan and scope for multiple maturation and spawning in a year
7. Thermal and salinity tolerances
8. Studies on digestive physiology
9. Studies on reproductive biology and physiology

Studies A and B will generate a reference data bank for each species upon which further development-oriented research (genetic selection and hybridization) can be built.

C. GENETIC SELECTION AND HYBRIDIZATION

The objective of genetic selection and hybridization is to develop domesticated strains exhibiting desirable culture performance traits including:

1. Fast growth rate
2. Hardiness, tolerance to adverse environments
3. Disease resistance
4. High dressing weight ratio

Good nutritional value

6. Good palatability (flavor, quality and texture)
7. Good feed conversion ratio
8. Good reproductive performance (for broodfish)

For research approaches, see Chapter 7. It may be possible to produce sexually sterile fish for growout with high culture performance.

II. Hatchery Engineering

- A. Most efficient designs and use of materials for a carp hatchery proper and its various components such as breeding, hatching and rearing tanks, their capacities, etc.
- B. Most effective bottom configuration, shape, area, volume, space distribution and location of the field components of a hatchery such as nursery, rearing, stock, broodfish holding and recovery ponds
- C. Most effective embankment slopes and width bearing in mind eventual mechanization of operations, transport of men and material for maintenance needs of ponds
- D. Designing the most effective air and water supply system to serve the needs of breeding, hatching and other tanks
- E. Most effective method of swamp reclamation, raising bunds and embankments for a fish farm
- F. Most effective method of rectifying soil porosity without losing the soil base for aquaculture, e.g., replacing top soil on pond beds after excavation
- G. Economics of hatchery engineering correlated with production capacity and manpower requirements

III. Broodfish Husbandry

- A. Formulating good broodfish diets based on nutritional studies which quantify protein, carbohydrate lipid, mineral and vitamin requirements and improvements in feed presentation
- B. Maximizing fecundity among sexed female brooder carps and milt yield among male brooder carps based on nutritional improvements
- C. Determining the possibility of multiple maturation and spawning during a year and the factors affecting periodicity
- D. Determining optimum stocking densities and combinations of broodfish in mono- or polyculture with or without sex segregation
- E. Improving methods for ascertaining readiness for spawning. This is a most important topic, since no induced spawning agent, however powerful, can act on fish which are not ready for stimulation to complete the first stages of oogenesis and spawning
- F. Further work on purification and characterization of fish gonadotropins and other induced spawning agents to avoid injecting crude whole pituitary extract
- G. Evolving methods of controlled breeding to ensure optimum ovulation, spermiation and fertilization, hatching and production of postlarvae with minimum of exogenous hormonal or other chemical treatments
- H. Finding effective synthetic chemical agents for the control of maturation and spawning which are easy and inexpensive to obtain and have a long shelf life

IV. Larval Rearing

A. WATER QUALITY

1. Quantitative determination of ideal water quality criteria for a carp hatchery (e.g., in regard to acidity, alkalinity, calcium, carbon dioxide, chloride, hardness, hydrogen, nitrate, oxygen, phosphorous, potassium, iron, turbidity and dissolved solids contents)
2. Determining the effects of variations of water quality parameters singly and interactively on water hardening of carp eggs, embryonic development, hatching and larval development
3. Determining methods of rectification of abnormal water quality conditions in respect of criteria listed above, e.g., inexpensive methods of remedying water turbidity
4. Determination of aeration needs and design of cost effective systems

B. SOIL QUALITY

1. Quantitative determination of ideal soil quality criteria for fish farm ponds in terms of physical and chemical parameters
2. Determining effects of growing and incorporating leguminous plants in pond soil on the nutritional status of soil and water of nursery and rearing ponds
3. Determining appropriate levels of fertilization with organic manures from different sources (such as livestock and poultry excreta), inorganic fertilizers and trace elements to optimize pond production having regard to cost/benefits
4. Developing inexpensive methods of minimizing seepage through porous soils without loss of soil-water interface relationships

C. POSTLARVAL NURSING

1. Developing improved mass culture techniques and delivery systems for live postlarval food organisms (rotifers, *Paramecium*, *Artemia* nauplii)
2. Developing more effective methods of eradicating predatory insects, unwanted biota, predatory and weed fishes in nursery ponds
3. Studies on the digestive physiology and nutrition of postlarvae, developing complete or supplementary feeds with adequate protein, carbohydrate, lipids, minerals and vitamins contents and improvement of feed presentation (particle size, methods and frequency of feeding) to give optimal conversion ratios
4. Studies of postlarval diseases caused by viruses, bacteria, fungi, protozoans and helminths; their prophylaxis and treatment methods
5. Developing methods of water quality control and maintenance of water quality at optimal physicochemical conditions (especially dissolved oxygen and ammonia content) for maximization of stocking, survival and growth rates
6. Studies of methods of control of algal blooms without adversely affecting fish populations
7. Studies of methods of predator control, especially frogs, insects and crustaceans
8. Studies of the economics of postlarval nursing as an industry
9. Studies of methods for long distance transport of postlarvae

D. FRY REARING

1. Developing techniques for mass culture of live fry food organisms (cladocerans, copepods and other crustaceans) and for live food delivery systems to optimize stocking, survival and growth rates in fry rearing
2. Studies of the digestive physiology and nutrition of fry, developing complete or supplementary feeds with adequate protein, carbohydrate, lipids, minerals and vitamin contents of and improvement of feed presentation methods as described for postlarvae above
3. Studies of fry diseases caused by viruses, bacteria, fungi, protozoans and helminths, their prophylaxis, and treatment methods
4. Studies of methods to control algal blooms and to prevent excessive growth of macrovegetation without affecting fish populations
5. Developing methods of water quality control and maintenance of water quality at optimal physicochemical conditions (especially dissolved oxygen content) for maximization of stocking, survival and growth rates
6. Studies of the economics of fry rearing as an industry
7. Studies of methods for long distance transport of fry
8. Studies of methods for predator control

V. Hatchery Management

Under hatchery management is covered the coordination of various hatchery activities and the determination of methods of obtaining the highest possible economic yields. Such an approach should be applied to hatchery work with common carp, monoculture of any one carp and polyculture of two or more species. It requires not only the application of the best and latest materials and techniques from improvements sought in the sections above on genetic improvement, hatchery engineering, controlled breeding and larval rearing but also a harmonious blending of these. The main areas of study for improvements in hatchery management are:

1. Physicochemical constraints of the environment
2. Occurrence and utilization of macro- and microecological niches in aquatic systems
3. Deleterious effects of accumulating metabolites such as ammonia and methods of eliminating them
4. Sizes and stocking densities of different species in diverse combinations so that they not only complement each other but even act synergistically (e.g., the fertilizing effect of fish feces in ponds)
5. Integration of fish culture with crops, livestock (poultry, piggery, duck raising), dairy, horticulture, sericulture and forestry
6. Studies of methods of elimination of pests, predators diseases and parasitic infestations
7. Development of better hatchery sanitation and hygiene
8. Studies of the economics of integrated systems

Personnel Requirements

The personnel requirements of a hatchery depend on the magnitude of the facilities to be manned. A hatchery is not an establishment where unskilled laborers can routinely work for a fixed number of hours per day and earn their wages. Most tasks in a hatchery require special skills. All require diligence and dedication. The workers should have keen interest in progress of science, emotional involvement and a will to succeed in each task. Hatchery work occupies irregular hours, quite often a

whole night's vigil, especially in the fish breeding season and occasionally, even over 24 hours of work at a stretch. Three levels of trained personnel are required,¹ semi-technical, technical and scientific.

No studies are available, as in a factory or engineering plant working on assembly line principle, linking manpower required per unit area of land or product. The proprietor of the hatchery has to learn by advice and experience how many trained persons are required.

The approach followed here is to indicate how many workers at a time are required for each operation. The same persons can repeat identical tasks and carry out additional tasks at a different time. The various tasks covered here and the category of staff required for each are as shown in Table 11.1.

Task	Unit	Category of staff required	Number of persons/unit of operation
1. Seine net operation	One pond (0.2 to 1.0 ha) area	Semi-technical (fishermen – seine operator)	6
2. Within hatchery transport of broodfish	Live broodfish weighing 1 kg to 15 kg each	Semi-technical	2
3. Induced breeding operations including sorting, holding, injecting and transporting fish	Live broodfish weighing 1 kg to 15 kg each	Technical	3
4. Stripping operations including causing ova release and milt emission simultaneously	Live spawners weighing 1 kg to 15 kg	Technical	3
5. Transporting carp eggs from breeding tanks to hatching jars	Hammock-like canvas sacs	Technical	2
6. Maintenance of hatchery proper	—	Technical	6
7. Packing for transport	Medium sized plastic bags one oxygen cylinder	Technical	3
8. Water and soil analysis and research in soil and water chemistry	—	Scientific (Chemist)	1 with 2 technical assistants
9. Research in induced breeding	—	Scientific (Endocrinology)	1 with 2 technical assistants
10. Hatchery engineering: contour survey, etc.	—	Civil Engineer (Irrigation Engineer)	1 with 2 technical assistants
11. Larval rearing	—	Scientific (Diologist)	1 with 3 technical assistants
12. Farm management	—	Scientific (Biologist)	1 with 3 technical assistants
13. Cost benefit studies in various operations	—	Scientific (Economist)	1 with 2 data collectors

¹The levels do not include untrained staff, e.g., laborers for making roads, cutting grass, etc.; watchers; watch and ward staff; orderlies; messengers and others.

Special Research Requirements

The following are the requirements of technically qualified staff for conducting research on selected disciplines.

Discipline	Personnel	Facilities
1. Genetics	A geneticist (Scientist)	<ul style="list-style-type: none"> -- Special laboratory equipment appropriate to the discipline e.g., electrophoretic equipment, data analysis (microcomputer with statistical software) — A large number of small ponds, tanks and aquaria for isolating families and individual fish; some large mutually isolated ponds for propagation of selected strains
2. Nutrition	A nutritionist (Scientist)	<ul style="list-style-type: none"> — Special laboratory equipment for feed formulation appropriate to discipline e.g., equipment for analytical chemistry and biochemistry — A large number of tanks and aquaria for feeding trials
3. Fish pathology	A fish pathologist/ parasitologist (Scientist)	<ul style="list-style-type: none"> — Special laboratory equipment appropriate to discipline e.g., histological equipment and good microscopes — A large number of tanks and aquaria for treatment trials with at least some well isolated from the main facility for quarantine and treatment purposes

Chapter 12

Routine Upkeep and Maintenance Tasks

In this Chapter are listed routine year-round tasks which should be performed by the scientific and technical personnel of the hatchery in order to keep the hatchery at peak efficiency. The methodologies for various tasks are given in the Manual. The tasks to be performed are on the following subjects and are in accordance with present day scientific knowledge of each subject.

Chinese and Indian Major Carps

BROODFISH AND SPENT FISH CARE

These activities are tuned to the performance of breeding operations in association with southwest monsoon (May-August) as is the case in majority of the countries of South and Southeast Asia.¹

Frequency	Task
October-December	Stock maturing fish which are would-be spawners in broodfish ponds.
<i>Daily</i> (Morning and Evening) (Day of stocking to July end)	Feed at 3% of body weight/day with feeds as mentioned in the Manual. Raise rate of feeding to 5% of body weight from February onwards. (Also for special dietetic requirements of selected species, see Chapter 8 under "Feeds".)
<i>Once a week</i> (March-July)	Flush to the extent of changing about 50% of the broodfish pond water with fresh cold water (25°C to 26°C) for about 1 hour each time.

¹In countries or regions where bulk of the breeding of Chinese and Indian major carps occurs in association with northeast monsoon (e.g., Sri Lanka), the timings of tasks would have to be appropriately changed; so also in countries and regions where these fish breed in association with southwest as well as northeast monsoons or throughout the year.

Once in two weeks
(February-August)

Take Secchi Disc readings in every broodfish pond. Collect zooplankton and maintain the same at densities of 30-50 ml organisms/1,000 ml especially in catla and bighead ponds and rectify if necessary with additional fertilization.

Once a month
(January-July)

Fertilize with organic and inorganic fertilizers at recommended doses. Add additional fertilizer as indicated in observations on plankton.

Once in two months

Check for ectoparasitic infestation and external microbial infections; take prophylactic measures and rectify by medication as necessary (see Chapter 9).

Day of Stocking

Check dissolved oxygen (DO) level² in pond water which should not be less than 6 ppm before stocking.

As and when spawning is done
(March-September)

Tag each broodfish both male and female after spawning. Stock spent fish in separate broodfish ponds. Record observations on health, survival, maturation, rematuration in log books.

Once in two weeks after breeding
(April-September)

Examine spent fish for rematuration.

Continue the regular tasks described above in spent fish ponds.

INDUCED BREEDING

The only task to be done besides breeding operations is timely collection and preservation of pituitary glands. It should be borne in mind that the task of pituitary gland collection is to be done strictly in the breeding season. The glands collected in other seasons are not expected to have sufficient amounts of gonadotropic hormone and injection with such material may not cause ovulation. Other ovulating agents, as described in the Manual and listed in Chapter 10, are to be procured and kept handy for use during the breeding operations.

Frequency	Task
<i>Daily</i> From mature fish exclusively during April-June	Collect pituitary glands (preferably homoplastic) from female donors.

Continued

²Check also periodically if fish show signs of respiratory distress. Check especially early morning DO just before dawn.

Daily

From mature fish exclusively during March and October or thereabouts in all countries of South and Southeast Asia where common carp breeds during spring (March-April) and autumn (October-November).

Collect heteroplastic pituitary glands from common carp donors for breeding Chinese and Indian major carps.

Daily during season of collection of pituitary glands

Store glands contained in stoppered vials in alcohol or after acetone-drying as described in the Manual.

POSTLARVAL NURSING IN NURSERY PONDS
AND FRY REARING IN REARING PONDS

In these operations, the day of reference for their timing is the approximate date of stocking postlarvae in nursery ponds, which has been taken as Day 0. In rearing ponds, Day 0 is taken as the date of stocking of fry for raising them to fingerling stage. Some of the important tasks in the preparation of nursery ponds and rearing ponds are to be performed during the pre-stocking phase. The number of days ahead of the stocking date (Day 0), in which the task in question is to be done or commenced, is indicated by a minus sign (–) preceding the day when the tasks are to be done.

Running total of days	Number of days that may be required	Number of days before the anticipated date of stocking	Task
Pre-stocking operations			
	5	–96	Drain nursery ponds unless already dry.
9	4	–91	Expose pond bottom and dry it.
11	2	–87	Plough pond bottom.
71	60	–85	Grow leguminous crop, e.g., peas, beans, etc., accompanied with mild watering if necessary. ^a
73	2	–25	Replough pond bottom and incorporate leguminous crop in pond bottom soil and mend pond slopes.
74	1	–23	Fill the nursery pond with water.
80	6	–22	Eradicate unwanted fish if any, with toxicants or piscicides, e.g., derris powder, teaseed cake, <i>Bassia latifolia</i> etc. ^b
82	2	–16	Lime the pond. ^c Check pH after liming.

Continued

Table 12.1. (continued)

Running total of days	Number of days that may be required	Number of days before the anticipated date of stocking	Task
88	6	-14	Apply organic manure ^c and inorganic fertilizer. Use land vegetation as pond fertilizer.
95	7	-8	Eradicate predatory insects and other harmful biota.
		(If an organophosphate formulation is used, otherwise, -4)	
96	1	-1	Collect zooplankton and check on rotifer abundance under a microscope immediately before stocking. ^d
Day of stocking		0	Check pH and oxygen level just before actual stocking: the former should be 7.8 and latter ≥ 6 ppm. Stocking operations.
		Post-stocking Operations	
		+1	Maintain dense zooplankton population with further manuring and fertilization at maintenance dose rates.
		+1	Feeding operations as described in manual. Check zooplankton, pH and dissolved oxygen.
		Twice a week	Health check (check for external infection).

^aAlthough in principle it is a sound practice to sow a leguminous crop, few fish farmers actually practice it. The worker should try it experimentally before making it a regular practice in an aquacultural operation.

^bSince a wide choice of substances is available for adopting different steps—for example, rotenone, tea-seed cake or tobacco waste as fish toxicants, the worker should work out a timetable for various operations and tasks depending on substances he uses.

^cLiming as well as application of organic manure can also be done on the pond bottom before filling water. Liming is not always necessary.

^dArtificial feeds should be kept handy in case the plankton population is not dense enough.

It may be seen that the nursery pond preparation has to begin more than three months (-96 days) before the anticipated date of stocking.

For raising subsequent crops of fry in the same nursery pond, organic manure and inorganic fertilizers may be applied at maintenance doses and for sustenance of production of natural food 5-6 days before stocking the next lot of postlarvae. Organophosphate treatment can be omitted unless predatory insects have recolonized the pond. Again, artificial feeds should be kept handy in case natural feeds are insufficient.

For rearing pond preparation, dense populations of zooplankton larger than rotifers, are required. Treatment with an organophosphate is still required for effecting insect control but after its toxicity has waned (which should take not more than 4-7 days at the low dose in which it is to be used), an inoculum of suitable cladocerans (e.g., *Moina* sp.) should be made to the ponds. A dense population should then build up in the course of one or two weeks. Rearing ponds in which cladocerans abound are ideal for stocking carp fry. It is advisable to keep some dense stock cultures of cladocerans in tanks, plastic pools or small ponds for this purpose.

HATCHERY RECORDS AND MAINTENANCE

A hatchery manager should maintain a daily diary of tasks performed and keep log books on different subjects. A stock book for recording stocks of fish and their movements, sales, etc., is needed. On induced breeding operations, it is necessary to keep records in log books on every fish, the sex, weight, weather conditions, water temperature, injections given, injection route, timings of injections, egg or sperm production, extent of fertilization, hatching and survival up to hatching stage. These data should be analyzed at the end of the season.

Hatchery maintenance requires the following tasks to be performed for which there is no periodicity. The various tasks are, however, best performed twice in a year at the end and beginning of the breeding season. The tasks are:

1. Clean sand and gravel and reverse flow filters. (Changing the direction of water flow helps to clean them effectively.)
2. Mend pond embankment slopes.
3. Mend rat and crab holes on embankment sides and top.
4. Mend diggings in common carp pond sides.
5. Maintain turf on embankment tops and sides.
6. Oil and grease pumps and joints in lever handles of various machines.
7. Oil and grease sluice gate control structures.
8. Remove mud and silt from manholes; drain channels, sedimentation and settling tanks.
9. Repair or replace planks in sluices and monks.
10. Make compost in specially prepared pits at an isolated spot in the fish farm.³
11. Keep log books for all major items of equipment such as generators, pumps, compressors, blowers and electric motors. Record the number of hours of service and follow the manufacturers instructions regarding routine service and maintenance.
12. Maintain a complete inventory of all equipment and chemicals together with location of poisons—(locked poison cabinet), fertilizers, feeds, etc.

LABORATORY UPKEEP

The following tasks need to be carried out daily in the hatchery laboratory:

1. Clean and put away all glassware and instruments.
2. Remove dry battery cells from instruments.
3. Put away hormones and perishables in a refrigerator or deep freezer.
4. Clean microscope lenses with lens tissue.
5. Cover the microscopes.
6. Cover all analytical, data processing and measuring equipment.

³Water hyacinth, which abounds in most countries of South and Southeast Asia, may be used for making compost (see Chapter 5). A fish farm may be made self-sufficient in its annual requirement of organic manure if total requirement of manure is computed and compost made. The period from October to January is the best time for filling compost pits in countries where carps breed in Southwest monsoon months.

Two patterns of breeding of the common carp occur in South and Southeast Asia: (1) twice-a-year breeding in spring (March-April) and autumn (September-October) and (2) breeding throughout the year (e.g., in Indonesia).

In common carp broodfish care, the two sexes must be stocked in separate ponds to prevent uncontrolled breeding, the other aspects of broodfish care remaining the same as those for the Chinese and Indian major carps described above.

Common carp ordinarily needs no induction to breed (unless for special reasons gonadotropic hormone is desired to be injected). It deposits adhesive eggs and the task of timely preparing framed *kakabans* for installation in the breeding ponds or in hatching tanks inside a hatchery is an additional requirement for common carp breeding.

The tasks of postlarval nursing and fry rearing of common carp young are identical to those of Chinese and Indian major carps and are not given separately in the Manual.

References

- Alikunhi, K.H. 1956. Fish culture techniques in India, p. 63-73. *In* Progress of fisheries development in India. Central Inland Fisheries Research Institute and Department of Fisheries, Orissa, India.
- Alikunhi, K.H. 1957. Fish culture in India. Farming Bull. Indian Council Agric. Res. 20. 144 p.
- Alikunhi, K.H. 1966. Synopsis of biological data on common carp *Cyprinus carpio* (Linnaeus, 1758). (Asia and Far East). FAO Fish. Synop. 31(1). 73 p.
- Alikunhi, K.H. and S. Parameswaran. 1963. Induced spawning of Chinese carps *Ctenopharyngodon idella* (C. & V.) and *Hypophthalmichthys molitrix* (C. & V.) in ponds at Cuttack India. Proc.—Indo-Pac. Fish. Council. 10(2): 181-204.
- Alikunhi, K.H. and K.K. Sukumaran. 1965. Observations on growth, maturity and feeding of induced-bred, pond-reared silver carp, *Hypophthalmichthys molitrix* and grass carp, *Ctenopharyngodon idella* in India during July 1962 to August 1963. Bull. Cent. Inst. Fish. Educ., Bombay 2. 19 p.
- Alikunhi, K.H., H. Chaudhuri and V. Ramchandran. 1952. Response to transplantation of fishes in India, with special reference to conditions of existence of carp fry. J. Asiat. Soc. (Sci.) 18(1): 35-53.
- Appelbaum, S. 1977. A possible substitute for live food of carp fry. Arch. Fischereiwiss. 28(1): 31-44.
- Appelbaum, S. and U. Dor. 1978. Ten-day experimental nursing of carp (*Cyprinus carpio* L.) larvae with dry feed. Bamidgah 30(3): 85-88.
- Appelbaum, S. and B. Uland. 1979. Intensive rearing of grass carp larvae *Ctenopharyngodon idella* (Valenciennes 1844) under controlled conditions. Aquaculture 17: 175-179.
- Bardach, J.B., J.H. Ryther and W.O. McLarney, editors. 1972. Aquaculture: the farming and husbandry of freshwater and marine organisms. Wiley-Interscience, New York.
- Berg, L.S. 1940. Classification of fishes, both recent and fossil. Reprint 1947. Trav. Inst. Zool. Acad. Sci. USSR 5(2). 517 p.
- Bhowmick, R.M. 1978. Glassjar hatchery for Indian major carps and Chinese carps. *In* Indian J. Fish. 25(1/2): 171-179.
- Bryant, P.L. and A.J. Matty. 1980. Optimisation of *Artemia* feeding rate for carp larvae (*Cyprinus carpio* L.). Aquaculture 21: 203-212.
- Chacko, P.I. and G.K. Kuriyan. 1948. On the bionomics of *Catla catla* (Cuv. and Val.) in south Indian waters. Curr. Sci. 17: 191.
- Chacko, P.I. and G.K. Kuriyan. 1950. The bionomics of the carp, *Catla catla* (Cuv. and Val.) in south Indian waters. Proc. Zool. Soc. Lond. 120: 39-42.
- Chacko, P.I. and S.V. Ganapati. 1951. Bionomics of the Mrigal, *Cirrhina mrigala* (Hamilton) in south Indian waters. J. Bombay Nat. Hist. Soc. 50(1): 13-19.
- Chakrabarty, R.D. and S.B. Singh. 1963. Observations on some aspects of the fishery and biology of the Mrigal, *Cirrhina mrigala* (Hamilton) from Allahabad. Indian J. Fish. 10A(1): 209-232.
- Chang, W.Y.B., J.S. Diana and W. Chuapohetz. 1983. Workshop report to agency for international development, 19-29 April 1983. Strengthening of South-east Asian Aquaculture Institutions (Grant No. DAN 5543-G-SS-2103-00). 30 p. Mimeo.
- Chaudhuri, H. 1963. Induced breeding of Indian carps. Proc. Natl. Inst. Sci. India, Part B 29(4): 478-487.
- Chaudhuri, H. 1973. Fertility of hybrids of Indian carps and preliminary studies of the F₂ generation of carp hybrids. J. Inland Fish. Soc. India: 195-200.
- Chow, K.W. 1980. Microencapsulated egg diets for fish larvae, p. 355-361. *In* Fish feed technology. ADCP/REP/8011. Aquaculture Development and Coordination Programme, FAO, Rome.

- CIFE. 1979-1980. Technology Transfer in Rural Areas, Education Research and Training Programme. Central Institute of Fisheries Education, Versova, Bombay.
- CIFE. 1983. Aquaculture and Hatchery Engineering Training Programme, Madhya Pradesh, 5-18 May 1983. Central Institute of Fisheries Education, Versova, Bombay.
- Falconer, D.S. 1981. Introduction to quantitative genetics. 2nd ed. Longmans, London.
- Gohl, B. 1975. Tropical feeds. FAO, Rome.
- Gunther, A. 1868. Cat fish. Bull. Brit. Mus. Lond. 7: 25.
- Hamsa, N. 1971. Preliminary account of an intergeneric, fertile hybrid between *Cirrhina mrigala* and *Labeo rohita*, p. 10-15. In Central Institute of Fisheries Education Recreation Club Souvenir.
- Hanumantharao, L. 1971. Studies on the Biology of *Cirrhinus mrigala* (Ham.) of the River Godavari. Indian J. Fish. 21(2): 303-322
- Harvey, B.J. and W.S. Hoar. 1979. Theory and practice of induced breeding in fish. International Development Research Centre, Ottawa, Canada.
- Hepher, B. and S. Sandbank. 1984. The effect of phosphorous supplementation to common carp diets on growth. Aquaculture 36: 323-332.
- Hickling, C.F. 1968. Fish hybridization. FAO Fish. Rep. 44(4): 1-11.
- Hora, S.L. and T.V.R. Pillay. 1962. Handbook on fish culture in the Indo-Pacific Region. FAO Fish. Tech. Pap. 14. 204 p.
- Horwitz, W. 1980. Official methods of analysis of the Association of Official Analytical Chemists (A.O.A.C.). A.O.A.C., Washington.
- Houssay, B.A. 1931. Action sexuelle de l'hypophyse sur les poissons et les reptiles. C.R. Soc. Biol. 106: 377-378.
- Huet, M. 1972. Textbook of fish culture: breeding and cultivation of fish. Fishing News Books Ltd., Farnham, Surrey, England.
- Inaba, D., M. Nomura and M. Nakamura. 1957. Preliminary report on the spawning of grass carp and silver carp in the Tone river Japan and the development of their eggs. J. Tokyo Univ. Fish. 43(1): 81-96.
- International Development Research Centre. 1983. Fish quarantine and fish diseases in Southeast Asia: report of a workshop held in Jakarta, Indonesia, 7-10 December 1982. 79 p. IDRC, Ottawa, Canada.
- Jauncey, K. 1982. Carp (*Cyprinus carpio* L.) nutrition: a review, p. 216-263. in J.F. Muir and R.J. Roberts (eds.) Recent advances in aquaculture. Croom Helm, London.
- Jauncey, K. and B. Ross. 1982. A guide to tilapia feeds and feeding. Institute of Aquaculture, University of Stirling, Stirling, Scotland.
- Jhingran, V.G. 1968. Synopsis of biological data on catla, *Catla catla* (Hamilton, 1822). FAO Fish. Synop. 32, Rev. 1. 78 p.
- Jhingran, V.G. 1983. Fish and fisheries of India. 2nd ed. Hindustan Publishing Corporation, Delhi.
- Jhingran, V.G. and H.A. Khan. 1979. Synopsis of biological data on the mrigal *Cirrhinus mrigala* (Hamilton, 1822). FAO Fish. Synop. 120. 78 p.
- Khan, H. 1924. Observations on the breeding habits of some freshwater fishes in the Punjab. J. Bombay Nat. Hist. Soc. 29 (4): 958-962.
- Khan, H. 1934. Habits and habitats of food fishes of the Punjab. J. Bombay Nat. Hist. Soc. 37(3): 655-668.
- Khan, H.A. and V.G. Jhingran. 1975. Synopsis of biological data on rohu, *Labeo rohita* (Hamilton, 1822). FAO Fish. Synop. 111. 100 p.
- Khan, R.A. 1972. Studies on the biology of some important major carps. Aligarh Muslim University, Aligarh. 185 p. M.S. thesis.
- Kirpichnikov, V.S. 1967. Efficiency of mass selection and selection of relatives in fish culture. FAO Fish. Rep. (44)4: 179-194.
- Kuronuma, K. 1968. New systems and new fishes for culture in the Far East. FAO Fish. Rep. (44)5: 123-142.
- Lin, S.Y. 1935. Life history of Woon je, *Ctenopharyngodon idellus* (C and V). Lingnan. Sci. J. 14(1): 129-132; 14(2): 271-274.
- Lubzens, E., G. Sagie, G. Minkoff, E. Meragelman and A. Schneller. 1984. Rotifers (*Brachionus plicatilis*) improve growth rate of carp (*Cyprinus carpio*) larvae. Barnidgeh 36(2): 41-46.

- MAFF. n.d. Test requirements for health certification of fish egg imports. Ministry of Agriculture, Fisheries and Foods, London.
- Mammen, T.A. 1962. Live fish transport using modified splashless carrier with compressed air aeration—In: Training Course on Live Fish Transport, 19-21 November, Hyderabad Fisheries Extension Unit, Govt. of India.
- McDaniel, D., editor. 1979. Procedures for the detection and identification of certain fish pathogens. Rev. ed. American Fisheries Society, Bethesda, Maryland.
- Menon, M.D., S. Srinivasan and B. Krishnamurthi. 1959. Report to the Indian Council of Agricultural Research on the Madras rural piscicultural scheme worked from 1 July 1942 to 31 March 1952. Govt. Press, Madras, India.
- Natarajan, A.V. and A.G. Jhingran. 1961. Index of preponderance—a method of grading the food elements in the stomach analysis of fishes. *Indian J. Fish.* 8(1): 54-59.
- Natarajan, A.V. and A.G. Jhingran. 1963. On the biology of *Catla catla* (Ham.) from the river Yamuna. *Proc. Natl. Inst. Sci. India, Part B* 29(3): 326-355.
- Nehrin, D. 1965. Die Ansnutzung verschiedener Getreidearten und Hulsfruchte durch Karpfen. *Z.F. Fish.* 13NF: 181-190.
- Nose, T. 1978. Summary report on the requirements of essential amino acids for carp. EIFAC Symp. Finfish Nutrition and Feed Technology, Hamburg, June 1978. EIFAC/78/Symp. E/8. FAO, Rome.
- NRC. (National Research Council, Subcommittee on Warmwater Fish Nutrition). 1977. Nutrient requirements of warmwater fishes. National Academy of Sciences, Washington, D.C.
- NRC. (National Research Council, Subcommittee on Warmwater Fish Nutrition). 1983. Nutrient requirements of warmwater fishes and shellfishes. National Academy of Sciences, Washington, D.C. 102 p.
- Ogino, C. 1980. Requirement of carp and rainbow trout for essential amino acids. *Bull. Jap. Soc. Sci. Fish.* 46(2): 171-174.
- Okada, Y. 1960. Studies on freshwater fishes of Japan. *J. Fac. Fish. Univ. Mie* 4(2): 257-588.
- Patro, J.C. 1968. A note on a new fishcarrier, double barrel type. Department of Fisheries, Government of Orissa, India. 6 p. Mimeo.
- Pool, D., K. Ryder and C. Andrews. 1984. The control of *Bathrioccephalus acheilognalhi* in grass carp, *Ctenopharyngodon idella*, using praziquantel. *Fish. Manage.* 15: 31-33.
- Qasim, S.Z. and A. Quyyum. 1962. Spawning frequencies and breeding seasons of some freshwater fishes with special reference to those occurring in the plains of Northern India. *Indian J. Fish.* 8(1): 29-43.
- Ramchandran, V. 1963. The method and technique of using anhydrous ammonia for aquatic weed control. *Proc. Indo-Pac. Fish. Council.* 10: 146-153.
- Rothbard, S. 1982. Induced reproduction in cultivated cyprinids—the common carp and the group of Chinese carps. II. The rearing of larvae and the primary nursing of fry. *Bamidgeh* 34(1): 20-32.
- Schäperclaus, W. 1933. Textbook of pond culture: rearing and keeping of carp, trout and allied fishes (Tr. F. Hund), Fish, Leaflet. Wash. 311.
- Schoorbee, H.J. and F. de W. Brandt. 1982. Observations on some techniques employed for the removal of egg adhesiveness of the common carp. *Water S.A.* 4: 93-103.
- Schoorbee, H.J. and J.F. Prinsloo. 1984. Techniques and hatchery procedures in induced spawning of the European common carp, *Cyprinus carpio* and the Chinese carps *Ctenopharyngodon idella*, *Hypophthalmichthys molitrix* and *Aristichthys nobilis* in Transkei. *Water. S.A.* 10: 36-39.
- Singh, B.N. 1977. Oxygen consumption and the amount of oxygen required for transport of rohu and mrigal fingerlings. *J. Inland Fish. Soc. India* 9: 98-104.
- Snell, J.R., A.Q. Chowdhury, W.M. Bailey and K.E. Sneed. 1979. Design features of a carp hatchery in Bangladesh. In L.J. Allen and E.C. Kinney (eds.) Proceedings of the bio-engineering symposium for fish culture, Michigan, 16-18 October 1979. American Fisheries Society, Bethesda, Maryland.
- Subramanian, S. 1983. Eradication of fishes by application of ammonia. *Aquaculture* 35: 273-275
- Suzuki, R. and M. Yamaguchi. 1980. Meristic and morphometric characters of five races of *Cyprinus carpio*. *Jap. J. Ichthyol.* 27: 199-206.

- Swingle, H.S. 1947. Experiment in pond fertilization. Ala. Agric. Exp. Stn. Bull. 264. 34 p.
- Toor, H.S., H.S. Sehgal and R.S. Sehder. 1983. A case study of acute fish diseases in tanks loaded with high levels of organic manures. *Aquaculture* 35: 277-282.
- Ufodike, E.B.C. and A.J. Matty. 1983. Growth responses and nutrient digestibility in mirror carp (*Cyprinus carpio*) fed different levels of cassava and rice. *Aquaculture* 31: 41-50.
- Vanhaecke, P. and P. Sorgeloos. 1983. International study on *Artemia*. XXX. Bio-economic evaluation of the nutritional value for carp (*Cyprinus carpio* L.) larvae of nine *Artemia* strains. *Aquaculture* 32: 285-293.
- Viola, S. and Y. Arieli. 1983. Evaluation of different grains as basic ingredients in complete feeds for carp and tilapia culture. *Bamidgeh* 35(2): 38-43.
- Woynarovich, E. 1968. New systems and new fishes for culture in Europe. *FAO Fish Rep.* 44(5): 162-181.
- Woynarovich, E. 1969. Techniques of hypophysation of common carp, p. 1-11. *In* FAO/UNDP Regional seminar on induced breeding of cultivated fishes.
- Woynarovich, E. 1975. Elementary guide to fish culture in Nepal. FAO, Rome.
- Woynarovich, E. and A. Woynarovich. 1980. A modified technology for elimination of stickiness of common carp (*Cyprinus carpio*) eggs. *Aquacult. Hung.* 2: 19-21.
- Woynarovich, E. and L. Horvath. 1980. Artificial propagation of warm-water finfishes—a manual for extension. *FAO Fish. Tech. Pap.* 201. 183 p.
- Wu, H.W. and L. Chung. 1964. Progress and achievements in the artificial propagation of four farm fishes in China. *Contrib. Peking Symp. Gen* 150: 203-218.
- Zeitler, M.H., M. Kirchgessner and F.J. Schwarz. 1984. Effects of different protein and energy supplies on carcass composition of carp (*Cyprinus carpio* L.). *Aquaculture* 36: 37-48.

Appendix I

Additional Reading

INTRODUCTION

The works listed here have been chosen because of their usefulness either as general sources of reference or because they enlarge upon or exemplify important points made in some of the chapters. Brief annotations are given where necessary. The lists follow chapter headings, except that there is a great deal of overlap. For example, the general aquaculture texts listed under Chapter 1 contain information relevant to Chapters 2-6. The lists for Chapters 3, 4, 5 and 6 are combined under one heading because of the considerable overlap involved.

CHAPTER 1. CULTURED SPECIES OF CARPS AND THEIR BIONOMICS

- Boyd, C.E. 1979. Water quality in warmwater fish ponds. Auburn University, Agricultural Experiment Station, Auburn, Alabama.
- Boyd, C.E. 1982. Water quality management for pond fish culture. *Developments in Aquaculture and Fisheries Science*, 9. Elsevier Scientific Publishing Co., Amsterdam.
- Chaudhuri, H., N.G.S. Rao, G.N. Saha, M. Rout and D.R. Ranauyia. 1978. Record fish production through intensive fish culture in a farmer's ponds. *J. Inland Fish. Soc. India* 10: 19-27.
- Chen, T.P. 1976. *Aquaculture practices in Taiwan*. Page Bros., Norwich.
- Das, P., D. Kumar and M.K.G. Roy. 1975. National demonstration on composite fish culture in West Bengal. *J. Inland Fish. Soc. India* 7: 112-115.
- FAO. 1981. Problems of fish culture economics with special reference to carp culture in eastern Europe. EIFAC Tech. Pap. 40. 99 p.
- Fowler, M.C. and T.O. Robson. 1978. The effects of the food preferences and stocking rates of grass carp (*Ctenopharyngodon idella* Val.) on mixed plant communities. *Aquat. Bot.* 5: 261-276.
- Ghosh, A., M.K. Banerjee and L.H. Rao. 1973. Some observations on the cultural prospects of silver carp *Hypophthalmichthys molitrix* (Valenciennes) in sewage-fed ponds. *J. Inland Fish. Soc. India* 5: 131-133.
- Hickling, C.F. 1960. *The farming of fish*. Pergamon Press, Oxford.
- Hickling, C.F. 1967. On the biology of a herbivorous fish, the white amur or grass carp, *Ctenopharyngodon idella* Val. *Proc. R. Soc. Edinburgh Sect. B* 70(4): 62-81.
- Huisman, E.A. 1979. The culture of grass carp (*Ctenopharyngodon idella*, Val.) under artificial conditions, p. 491-500. *In* J.E. Halver and K. Tiews (eds.) *Finfish nutrition and fishfeed technology*, vol. 1. Heenemann Verlaggesellschaft, Berlin.
- Huisman, E.A. and P. Valentijn. 1981. Conversion efficiencies in grass carp (*Ctenopharyngodon idella*, Val.) using a feed for commercial production. *Aquaculture* 22: 279-288.
- Lin, H.R. 1982. Polycultural system of freshwater fish in China. *Can. J. Fish. Aquat. Sci.* 39(1): 143-150.
- Payne, A.I. 1979. Physiological and ecological factors in the development of fish culture. *Symp. Zool. Soc. London* 44: 383-415. (A very useful review of factors affecting growth and production; highly relevant to carp culture in fertilized ponds.)

- Pillay, T.V.R. and Wm. A. Dill, editors. 1979. *Advances in aquaculture*. Fishing News Books Ltd., Farnham, Surrey, England.
- Rappoport, U. and S. Sarig. 1975. The results of tests in intensive growth of fish at the Genosar (Israel) Station ponds in 1974. *Bamidgeh* 27: 75-82.
- Sarig, S. 1968. Synopsis of biological data on common carp, *Cyprinus carpio* (Linnaeus, 1758). (Near East and Europe). *FAO Fish. Synop.* 31(2). 73 p.
- Sinha, V.R.P. and M.V. Gupta. 1975. On the growth of the grass carp *Ctenopharyngodon idella* in composite fish culture at Kalyani, West Bengal (India). *Aquaculture* at Kalyani, West Bengal (India). *Aquaculture* 5: 283-290.
- Srivastava, J.B. and S.K. Chowdhary. 1979. Culture of *Catla catla* in a lentic impoundment in Jammu. *Aquaculture* 18: 283-285.
- Tapiador, D., H.F. Henderson, M.N. Delmendo and H. Tsutsui. 1977. Freshwater fisheries and aquaculture in China. *FAO Fish. Tech. Pap.* 168. 84 p.
- Venkatesh, B. and H.P.C. Shetty. 1978. Studies on the growth rate of the grass carp *Ctenopharyngodon idella* (Valenciennes) fed on two aquatic weeds and a terrestrial grass. *Aquaculture* 13: 45-73.

CHAPTER 2. COMPONENTS OF A HATCHERY: AREA AND SPACE DISTRIBUTION OF ITS PONDS¹

- Alabaster, J.S. and R. Lloyd. 1980. *Water quality criteria for freshwater fish*. Butterworths, London.
- Allen, L.J. and E.C. Kinney, editors. 1979. *Proceedings of the bio-engineering symposium for fish culture*. Fish Culture Section, American Fisheries Society, Bethesda, Maryland.
- Anon. 1979. *How to identify and control water weeds and algae*. 2nd rev. ed. Applied Biochemists Inc., Mequon, Wisconsin.
- APHA/AWWA/WPCF. 1981. *Standard methods for examination of water and wastewater*. 15th ed. American Public Health Association, American Water Works Association in Water Pollution Control Federation, Washington, D.C. (The standard work of reference for all water analysis: essential for water quality assessment in fish culture. Issued with supplement.)
- Bard, J., P. de Kimpe, J. Lazard, J. Lemasson and P. Lessent. 1976. *Handbook of tropical fish culture*. Centre Technique Forestier Tropical, Nogent-sur-Marne.
- Bennett, G.W. 1970. *Management of lakes and ponds*. 2nd ed. Van Nostrand Reinhold Co., New York.
- Cains, J. Jr. and K.L. Dukson, editors. 1976. *Biological methods for the assessment of water quality*. American Society for Testing and Materials, Philadelphia, Pa.
- Cansdale, G.S. 1979. Report on second regional consultancy low-cost water filtration. SCS/79/WP/84. 17 p. South China Sea Fisheries Development and Coordinating Programme, Manila.
- Chervinski, J. 1980. Note on the adaptability of bighead (*Aristichthys nobilis*) to various saline concentrations. *Bamidgeh* 32(1): 27-29. (Contains only experimental data and cannot be used as a guide for saline culture possibility.)
- Cuzon, G. 1980. Feasibility study for establishing a small aquaculture laboratory in the United Arab Emirates. UNDP/FAO regional fishery survey and development project. FI. DP/RAB/71/278/7. 26 p. FAO, Rome. (Although concerned with an experimental marine hatchery, this report is a useful pattern for designing and equipping other culture facilities.)
- Fishelson, L. and D. Popper. 1968. Experiments on rearing fish in saltwater near the Dead Sea, Israel. *FAO Fish. Rep.* 44(5): 244-245. (*Cyprinus carpio* was successfully cultured in waters containing 2,000 to 8,000 mg/l Cl).
- Lannan, J.E., R.O. Smitherman and G. Tchiyanoglous. 1983. Principles and practices of pond aquaculture: a state of the art review. USAID, Washington, D.C.
- Leitritz, E. and R.C. Lewis. 1976. Trout and salmon culture (hatchery methods). *Fish Bulletin* 164. 197 p. State of California Department of Fish and Game, Sacramento, California. (Although written for salmonid culturists, this classic work contains a wealth of information on hatchery equipment and design which is useful for application with other species.)

¹The scientific journal *Aquacultural Engineering* published by Applied Science Publisher Ltd., Barking, England is a useful source for new developments and the journal *Progressive Fish Culturist*, published by the American Fisheries Society, Bethesda, Maryland frequently has articles on hatchery design.

CHAPTERS 3, 4, 5 and 6. BROODFISH CARE; INDUCED SPAWNING OF CHINESE AND INDIAN MAJOR CARPS AND COMMON CARP BREEDING; POST-LARVAL AND FRY REARING TRANSPORT OF LIVE FISH-SEED AND BROODFISH²

- ADCP. 1978. Fish seed production and distribution in India: report of a mission to plan the expansion of fish-seed production. ADCP/MR/78/3/E. 53 p. FAO, Rome.
- Anon. 1977. A new highly effective ovulating agent for fish reproduction—practical application of LH-RH analogue for the induction of spawning of farm fishes. *Sci. Sin.* 20(4): 469-474.
- Anon. 1981a. Induced breeding of Indian and Chinese carps. Publication No. MKG/92. 15 p. Interim Committee for Coordination of Investigation of the Lower Mekong Basin, Secretariat, Bangkok.
- Anon. 1981b. Management of nursery ponds for rearing carp fry. Publication No. MKG/93. 12 p. Interim Committee for Coordination of Investigations of the Lower Mekong Basin, Secretariat, Bangkok.
- Bell, G.R. 1967. A guide to the properties, characteristics, and uses of some general anesthetics for fish. *Bull. Fish. Res. Board Can.* 148. 4 p.
- Bhowmick, R.M., G.V. Kowtal, B.K. Jana and S.D. Gupta. 1978. Large-scale production of the seed of catla, *Catla catla* (Ham.) by hypophysation. *J. Inland Fish. Soc. India* 10: 52-55.
- BIOTROP. 1974. Checklist of literature on induced fish breeding techniques. SEAMEO Regional Center for Tropical Biology, Bogor, Indonesia. (A useful selected bibliography on all aspect of fish-seed production to 1974 including hatchery/nursery techniques and seed transportation.)
- Chakrabarty, R.D., and D.S. Murty. 1972. Life history of Indian major carps, *Cirrhinus mrigala* (HAM.), *Catla catla* (HAM.) and *Labeo rohita* (HAM.). *J. Inland Fish. Soc. India* 6: 133-161.
- Chakrabarty, R.D., P.R. Sen, D.K. Chatterjee and G.V. Kowtal. 1973. Observations on the relative usefulness of different feed for carp spawn and fry. *J. Inland Fish. Soc. India* 5: 182-188.
- CIFRI. 1976. Glass jar hatchery for carps. Central Inland Fisheries Research Institute, Barrackpore, West Bengal, India.
- Davy, F.B. and A. Chouinard, editors. 1981. Induced fish breeding in Southeast Asia: report of a workshop held in Singapore, 25-28 November 1980. IDRC-178e. International Development Research Centre, Ottawa, Canada. (A brief summary report with papers appended on microfiche.)
- Dwivedi, S.N. and V. Ravindranathan. 1982. Carp hatchery model CIFE D-81: a new system to breed fish even when rains fail. *Bull. Cent. Inst. Fish. Educ., Bombay* 3-4. 19 p.
- FAO. 1975. Workshop on controlled reproduction of cultivated fishes. EIFAC Tech. Pap. 25. 180 p.
- FAO. 1980. The artificial propagation of warmwater finfishes: a manual for extension. FAO Fish. Tech. Pap. 201. 192 p.
- FAO. 1983. Freshwater aquaculture development in China. Report of the FAO/UNDP study tour organized for French-speaking African countries, 22 April-20 May 1980. FAO Fish. Tech. Pap. 215. 125 p.
- FAO. n.d. Rearing fry and fingerlings of Chinese carps—a 114-frame filmstrip and accompanying booklet for commentary, made in the People's Republic of China at the Kwangchow Freshwater Experimental Fish Farm and Training Center, Kwangtung Province. FAO, Rome.
- Hawkins, A.D., editor. 1981. Aquarium systems. Academic Press, London.
- Hersch, G. 1984. Goldfish without water. *Tropical fish hobbyist*, January: 16-23. (Describes a new technique for fingerling shipment in wet paper media.)
- Huisman, E.A. and H. Hoogendorn, editors. 1979. EIFAC workshop on mass rearing of fry and fingerlings of freshwater fishes/papers, The Hague, 8-11 May 1979. EIFAC Tech. Pap. 35, Suppl. 1. 202 p.

²Much information relevant to these chapters is contained in the Synopses of Data and the works on polyculture systems listed for Chapter 1.

- Hulata, G., R. Moav and G.W. Wohlfarth. 1976. The effects of maternal age, relative hatching time and density of stocking on growth rate of fry in the European and Chinese races of the common carp. *J. Fish. Biol.* 9: 499-513.
- Macintosh, D.J. n.d. Techniques in aquaculture: induced breeding (hypophysation). Institute of Aquaculture, University of Stirling, Stirling, Scotland. (A set of 20 color slides with guide notes.)
- Opuszynski, K., J.V. Stireman, F.J. Aldridge and R.W. Rottman. 1984. Environmental manipulation to stimulate rotifers in fish rearing ponds. *Aquaculture* 42: 343-348.
- Rothbard, S. 1981. Induced reproduction in cultivated cyprinids—the common carp and the group of Chinese carps. I. The technique of induction, spawning and hatching. *Bamidgeh* 33(4): 103-121.
- Tsai, C-F., M.N. Islam, M.R. Karim and K.U.M. Rahman. 1981. Spawning of major carps in the lower Halda River, Bangladesh. *Estuaries* 1(2): 127-138. (Describes a typical major carp spawning season.)
- Woyanovich, E. 1962. Hatching of carp eggs in "Zuger" flasks and breeding of carp larvae until an age of 10 days. *Bamidgeh* 14(2): 38-46.

CHAPTER 7. APPLIED GENETICS OF CULTURED CARPS

- Bakos, J. 1979. Crossbreeding Hungarian races of common carp to develop more productive hybrids, p. 633-635. *In* T.V.R. Pillay and Wm. A. Dill (eds.) *Advances in aquaculture*. Fishing News Books Ltd., Farnham, Surrey, England.
- Bakos, J., Z. Krasznai and T. Marian. 1978. Crossbreeding experiments with carp, tench and Asian phytophagous cyprinids. *Aquacult. Hung. (Szarvas)* 1: 51-57.
- Bhowmick, R.M., R.K. Jana, S.D. Gupta, G.V. Kowtal and M. Rout. 1981. Studies on some aspects of biology and morphometry of the intergeneric hybrid, *Catla catla* Hamilton x *Labeo rohita* Hamilton, produced by hypophysation. *Aquaculture* 23: 367-371.
- Brody, T.D., D. Kirsh, G. Parag, G.W. Wohlfarth, G. Hulata and R. Moav. 1979. Biochemical genetic comparison of the Chinese and European races of the common carp. *Anim. Blood Groups. Biochem. Genet.* 10: 141-149.
- Rye, V.J. and A.G. Ponniah. 1983. Application of genetics in aquaculture. CMFR# Special Publication No. 13, 89 p. Central Marine Fisheries Research Institute, Cochin. (An excellent handbook on applied genetics for fish culturists.)
- Chevassus, B. 1983. Hybridization in fish. *Aquaculture* 33: 245-262.
- Doyle, R.W. 1983. An approach to the quantitative analysis of domestication selection in aquaculture. *Aquaculture* 33: 167-185.
- FAO. 1981a. Conservation of the genetic resources of fish—problems and recommendations: report of the expert consultation on genetic resources of fish, Rome, 9-13 June 1980. *FAO Fish. Tech. Pap.* 217. 51 p.
- FAO. 1981b. Register of international transfers of inland fish species. *FAO Fish. Tech. Pap.* 213. 130 p.
- Gall, G.A.E. 1983. Genetics of fish: a summary of discussion. *Aquaculture* 33: 383-394.
- Garvai, J.S. Peter, A. Nagy, L. Horvath and V. Csanyi. 1980. Induced triploidy in carp, *Cyprinus carpio* L. *J. Fish Biol.* 17: 667-671.
- Gjedrem, T. 1983. Genetic variation in quantitative traits and selective breeding in fish and shellfish. *Aquaculture* 33: 51-72.
- Hines, R.S., G.W. Wohlfarth, R. Moav and G. Hulata. 1974. Genetic differences in susceptibility to two diseases among strains of the common carp. *Aquaculture* 3: 187-197.
- Kincaid, H.L. 1983. Inbreeding in fish populations used for aquaculture. *Aquaculture* 33: 215-227.
- King, R.C. 1955. *Genetics*. 2nd ed. Oxford University Press, Oxford.
- Kinghorn, B.P. 1983. A review of quantitative genetics in fish breeding. *Aquaculture* 31: 283-304.
- Kirpichnikov, V.S. 1981. *Genetic bases of fish selection*. Springer Verlag, Berlin.
- Moav, R. 1979. Genetic improvement in aquaculture industry, p. 610-622. *In* T.V.R. Pillay and W.A. Dill (eds.) *Advances in aquaculture*. Fishing News Books Ltd., Farnham, Surrey, England.
- Moav, R. and G.W. Wohlfarth. 1967. Genetic improvement of yield in carp. *FAO Fish Rep.* 44(4): 112-129.

- Moav, R. and G.W. Wohlfarth. 1974. Magnification through competition of genetic differences in yield capacity in carp. *Heredity* 13: 181-202.
- Moav, R. and G.W. Wohlfarth. 1976. Two-way selection for growth rate in the common carp (*Cyprinus carpio* L.). *Genetics* 82: 83-101.
- Moav, R., G. Hulata and G.W. Wohlfarth. 1975. Genetic differences between the Chinese and European races of the common carp. 1. Analysis of genotype-environment interactions for growth rate. *Heredity* 34: 323-340.
- Moav, R., T. Brody, G.W. Wohlfarth and G. Hulata. 1976. Application of electrophoretic genetic markers to fish breeding I. Advantages and methods. *Aquaculture* 9: 217-228.
- Moav, R., T. Brody, G.W. Wohlfarth and G. Hulata. 1979. A proposal for the continuous production of F₁ hybrids between the European and Chinese races of the common carp in traditional fish farms of Southeast Asia, p. 635-638. *In* T.V.R. Pillay and W.A. Dill (eds.) *Advances in aquaculture*. Fishing News Books Ltd., Farnham, Surrey, England.
- Nagy, A., K. Rajki, L. Horvath and V. Csanyi. 1978. Investigation on carp, *Cyprinus carpio* L. gynogenesis. *J. Fish. Biol.* 13: 215-224.
- Nagy, A., V. Csanyi, J. Bakos and L. Horvath. 1980. Development of a short term laboratory system for the evaluation of carp growth in ponds. *Bamidgeh* 32: 6-15.
- Schroder, J.H., editor. 1973. *Genetics and mutagenesis of fish*. Springer Verlag, New York.
- Sin, A.W. 1982. Stock improvement of common carp in Hong Kong through hybridization with the introduced Israeli race 'Dor-70'. *Aquaculture* 29: 299-304.
- Suzuki, R. and M. Yamaguchi. 1980. Improvement of quality in the common carp by cross-breeding. *Bull. Jap. Soc. Sci. Fish.* 46: 1427-1434.
- Suzuki, R., M. Yamaguchi and K. Ishikawa. 1977. Differences in growth rate in two races of the common carp at various water temperatures. *Bull. Freshwater Fish. Res. Lab.* 27(1): 21-26.
- Suzuki, R., M. Yamaguchi, T. Ito and J. Toi. 1976. Differences in growth and survival in various races of the common carp. *Bull. Freshwater Fish. Res. Lab.* 26(2): 59-69.
- Wilkins, N.P. 1981. The rationale and relevance of genetics in aquaculture: an overview. *Aquaculture* 22: 209-228.
- Wilkins, N.P. and E.M. Gosling, editors. 1983. *Genetics in aquaculture: proceedings of an international symposium held in University College, Galway, Ireland, 29 March-2 April 1982*. *Developments in Aquaculture and Fisheries Science*, 12. Elsevier, Amsterdam. (These conference proceedings are also available as a special volume of *Aquaculture*, Elsevier Scientific Publishing Co. *Aquaculture* 33(1-4), 1983.)
- Wohlfarth, G.W. 1977. Shoot carp. *Bamidgeh* 29: 35-56.
- Wohlfarth, G.W. 1983. Genetics of fish: applications to warm water fishes. *Aquaculture* 33: 373-381.
- Wohlfarth, G.W. and R. Moav. 1972. The regression of weight gain on initial weight in carp. I. Methods and results. *Aquaculture* 1: 7-28.
- Wohlfarth, G.W., R. Moav and G. Hulata. 1975. Genetic differences between the Chinese and European races of the common carp. II. Multi-character variation—a response to the diverse methods of fish cultivation in Europe and China. *Heredity* 34: 341-350.
- Wohlfarth, G.W., R. Moav and G. Hulata. 1983. A genotype-environment interaction for growth rate in the common carp, growing in intensively managed ponds. *Aquaculture* 33: 187-195.
- Wohlfarth, G.W., R. Moav, G. Hulata and A. Beiles. 1975. Genetic variation in seine escapability of the common carp. *Aquaculture* 5: 375-378.
- Wohlfarth, G.W., M. Lahman, G. Hulata and R. Moav. 1980. The story of "Dor-70" a selected strain of the Israeli common carp. *Bamidgeh* 32: 3-5.
- Yamazaki, F. 1983. Sex control and manipulation in fish. *Aquaculture* 33: 329-354.
- Zonova, A.S. and V.S. Kirpichnikov. 1971. The selection of røpska carp, p. 233-247. *In* FAO seminar/study tour in the USSR on genetic selection and hybridization of cultivated fishes. Rep. FAO/UNDP (TA) 2926, Rome.

CHAPTER 8. NUTRITION OF CULTURED CARPS

Aquaculture Development and Coordination Programme. 1980. Fish feed technology. ADCP/REP/80/11. 395 p. FAO/UNDP, Rome.

- Atack, T.H., K. Jauncey and A.J. Matty. 1979. The utilization of some single cell proteins by fingerling mirror carp (*Cyprinus carpio*). *Aquaculture* 18: 337-348.
- Bondi, A., A. Spandorf and S.R. Calmi. 1957. The nutritive value of various feeds for carp. *Bamidgeh* 9(1): 13-22.
- Bryant, P.L. and A.J. Matty. 1981. Adaptation of carp (*Cyprinus carpio*) larvae to artificial diets. 1. Optimum feeding rate and adaptation age for a commercial diet. *Aquaculture* 23: 275-286.
- Burrows, R.E. 1975. Nutrition and production of fish: techniques with complete diets, p. 176-182. *In* Nutrition and production of fish, vol. 3. S. Karger, Basel.
- Castell, J.D. 1979. Review of lipid requirements of finfish, p. 59-84. *In* J.E. Halver and K. Tiews (eds.) Finfish nutrition and fishfeed technology, vol. 1. Heenemann Verlagsgesellschaft mbH, Berlin.
- Cockrell, I., B. Francis and D. Halliday. 1971. Changes and nutritive value of concentrate feed-stuffs during storage. Tropical Products Institute, London.
- Committee on Food Protection, National Research Council. 1973. Toxicants occurring naturally in foods. National Research Council, Washington, D.C.
- Cowey, C.B. and J.R. Sargent. 1972. Fish nutrition. *Adv. Mar. Biol.* 10: 383-492.
- Cowey, C.B. and J.R. Sargent. 1979. Fish nutrition, p. 1-69. *In* W.S. Hoar and D.J. Randall (eds.) Fish physiology, vol. 8 Academic Press, New York.
- Csengeri, I., F. Majoros, J. Olah and T. Farkas. 1979. Investigations on the essential fatty acid requirement of carp (*Cyprinus carpio* L.), p. 157-173. *In* J.E. Halver and K. Tiews (eds.) Finfish nutrition and fishfeed technology, vol. 1. Heenemann Verlagsgesellschaft mbH, Berlin.
- Dabrowski, K. 1977. Protein requirements of grass carp fry (*Ctenopharyngodon idella* Val.). *Aquaculture* 12: 63-73.
- Dabrowski, K., H. Dabrowska and C. Grudniewski. 1978. A study of the feeding of common carp larvae with artificial food. *Aquaculture* 13: 257-264.
- FAO. 1980. Report of the EIFAC, IUNS and ICES working group on standardization of methodology in fish nutrition research. EIFAC Tech. Pap. 36. 24 p.
- Gaudet, J.L., editor. 1969. New developments in carp and trout nutrition—papers submitted to a symposium held in conjunction with the fifth session of EIFAC, Rome, May 1968. EIFAC Tech. Pap. 9. 213 p.
- Halver, J.E. 1972. Fish nutrition. Academic Press, New York.
- Halver, J.E. 1979. Vitamin requirements of finfish, p. 45-58. *In* J.E. Halver and K. Tiews (eds.) Finfish nutrition and fishfeed technology, vol. 1. Heenemann Verlagsgesellschaft mbH, Berlin.
- Halver, J.E. and K. Tiews, editors. 1979. Finfish nutrition and fishfeed technology. Heenemann Verlagsgesellschaft mbH, Berlin.
- Hashimoto, Y. 1975. Nutritional requirements of warm water fish, p. 158-175. *In* Nutrition of production of fish, vol. 3. S. Karger, Basel.
- Hepher, B. 1975. Supplementary feeding in fish culture, p. 183-198. *In* Nutrition and production of fish, vol. 3. S. Karger, Basel.
- Hepher, B., J. Chervinski and H. Tagari. 1971. Studies on carp nutrition. 3. Experiments on the effect of fish-yields of dietary protein source and concentration. *Bamidgeh* 23(1): 11-37.
- Horvath, L. 1979. The rearing of warmwater fish larvae, p. 349-357. *In* J.E. Halver and K. Tiews (eds.) Finfish nutrition and fishfeed technology, vol. 1. Heenemann Verlagsgesellschaft mbH, Berlin.
- Horvath, L., G. Tamas and E. Szabo. 1979. Nutrition-biological questions of bred cyprinids in the first month of their life, p. 467-477. *In* J.E. Halver and K. Tiews (eds.) Finfish nutrition and fishfeed technology, vol. 1. Heenemann Verlagsgesellschaft mbH, Berlin.
- Huisman, E.A. 1976. Food conversion efficiencies at maintenance and production levels for carp (*Cyprinus carpio* L.) and rainbow trout (*Salmo gairdneri* Rich.). *Aquaculture* 9: 259-273.
- Huisman, E.A. 1979. The culture of grass carp (*Ctenopharyngodon idella* Val.) under artificial conditions, p. 491-500. *In* J.E. Halver and K. Tiews (eds.) Finfish nutrition and fishfeed technology, vol. 1. Heenemann Verlagsgesellschaft mbH, Berlin.
- Huisman, E.A. and P. Valentijn. 1981. Conversion efficiencies in grass carp (*Ctenopharyngodon idella*, Val.) using a feed for commercial production. *Aquaculture* 22: 279-288.

- Huisman, E.A., J.G.P. Klein Breteler, M.M. Vismans and E. Kanis. 1979. Retention of energy, protein, fat and ash in growing carp (*Cyprinus carpio* L.) under different feeding and temperature regimes, p. 175-188. In J.E. Halver and K. Tiews (eds.) Finfish nutrition and fishfeed technology, vol. 1. Heenemann Verlagsgesellschaft mbH, Berlin.
- Kamel, S.M. and T. Kawano. 1980. Studies on mass culture of marine yeast, *Candida* sp. for feeding zooplankton and shrimp larvae. MFD/KISR Technical Report No. 005/80. 24 p. Mariculture and Fisheries Department, Kuwait Institute for Scientific Research, Salmiya, Kuwait.
- Kawano, T. and S M. Kamel. 1980. A bibliography on rotifers. MFD/KISR Technical Report No. 002/80. 18 p. Mariculture and Fisheries Department, Kuwait Institute for Scientific Research, Salmiya, Kuwait.
- Lakshmanan, M.A.V., O.S. Murty, K.K. Pillai and S.C. Banerjee. 1966. On a new artificial feed for carp fry. FAO Fish. Rep. 44(3): 373-387.
- Lovell, R.T. 1974. Laboratory manual for fish feed analysis and fish nutrition studies. Department of Fisheries and Allied Aquacultures, International Center for Aquaculture, Auburn University, Auburn, Alabama.
- Meyers, S.P. 1979. Formulation of water-stable diets for larval fishes, p. 13-20. In J.E. Halver and K. Tiews (eds.) Finfish nutrition and fishfeed technology, vol. II. Heenemann Verlagsgesellschaft mbH, Berlin.
- Meyers, S.P. and Z.P. Zein-Eldin. 1972. Binders and pellet stability in development of crustacean diets. Proc. Annu. Workshop World Maricult. Soc. 3: 351-364.
- Nose, T. 1979a. Summary report on the requirements of essential amino acids for carp, p. 145-146. In J.E. Halver and K. Tiews (eds.) Finfish nutrition and fishfeed technology, vol. 1. Heenemann Verlagsgesellschaft mbH, Berlin.
- Nose, T. 1979b. Diet compositions and feeding techniques in fish culture with complete diets, p. 283-296. In J.E. Halver and K. Tiews (eds.) Finfish nutrition and fishfeed technology, vol. 1. Heenemann Verlagsgesellschaft mbH, Berlin.
- Post, G. 1975. Ration formulation for intensively reared fishes, p. 199-207. In Nutrition and production of fish, vol. 3. S. Karger, Basel.
- Scherbina, M.A., B.F. Mogulskaya and E.Z. Errnan. 1970. A study of the digestibility of nutrients from artificial feeds by pond fish. I. The digestibility of nutrients from peanut cake, peas, barley and mixed feed by two-year-old carp. Vopr. Ikhtiol. 10: 876-882.
- Sen, P.R., N.G.S. Rao, S.R. Ghosh and M. Rout. 1978. Observations on the protein and carbohydrate requirements of carps. Aquaculture 13: 245-255.
- Shireman, J.V., D.E. Colle and R.W. Rottmann. 1978. Growth of grass carp fed natural and prepared diets under intensive culture. J. Fish. Biol. 12: 457-463.
- Shireman, J.V., R.W. Rottmann and F.J. Aldridge. 1983. Consumption and growth of hybrid grass carp fed four vegetation diets and trout chow in circular tanks. J. Fish Biol. 22(6): 685-693.
- Sin, A.W. 1973a. The dietary protein requirements for growth of young carp (*Cyprinus carpio*). Hong Kong Fish. Bull. 3: 77-81.
- Sin, A.W. 1973b. The utilization of dietary protein for growth of young carp (*Cyprinus carpio*) in relation to variations in fat intake. Hong Kong Fish. Bull. 3: 83-88.
- Singh, B.N., V.R.P. Sinha and D.P. Chakraborty. 1979. Effects of protein quality and temperature on the growth of fingerlings of rohu, *Labeo rohita* (Hamilton), p. 303-311. In J.E. Halver and K. Tiews (eds.) Finfish nutrition and fishfeed technology, vol. II. Heenemann Verlagsgesellschaft mbH, Berlin.
- Sorgeloos, P. 1976. A bibliography on the brine shrimp *Artemia salina* L. Eur. Maricult. Soc. Spec. Pub. 1. 107 p.
- Sorgeloos, P. 1979. List of commercial harvesters-distributors of *Artemia* cysts of different geographical origin. Aquaculture 16: 87-88.
- Sorgeloos, P. 1980. The use of the brine shrimp *Artemia* in aquaculture, p. 25-46. In G. Persoone, P. Sorgeloos, O. Roels and E. Jaspers (eds.) The brine shrimp *Artemia*. Vol. 3. Ecology, culturing, use in aquaculture. Universa Press, Wetteren, Belgium.
- Sorgeloos, P. 1981. Availability of reference *Artemia* cysts. Aquaculture 23: 381-382.
- Sorgeloos, P. Live animal food for larval rearing in aquaculture: the brine shrimp *Artemia*. In M. Bilio, H. Rosenthal and C. Sindermann (eds.) Realism in aquaculture: achievements, constraints, perspectives. (In press.)

- Sorgeloos, P., E. Bossuyt, E. Lavina, M. Baeza-Mesa and G. Persoone. 1977. Decapsulation of *Artemia* cysts: a simple technique for the improvement of the use of brine shrimp in aquaculture. *Aquaculture* 12: 311-315.
- Spinelli, J., C. Mahnken and M. Steinberg. 1979. Alternate sources of proteins for fish meal in salmonid diets, p. 131-142. *In* J.E. Halver and K. Tiews (eds.) *Finfish nutrition and fishfeed technology*, vol. II. Heenemann Verlagsgesellschaft mbH, Berlin.
- Takeuchi, T., T. Watanabe and C. Ogino. 1978. Use of hydrogenated fish oil and beef tallow as a dietary energy source for carp and rainbow trout. *Bull. Jap. Soc. Sci. Fish.* 44(8): 875-881.
- Takeuchi, T., T. Watanabe and C. Ogino. 1979. Optimum ratio of dietary energy to protein for carp. *Bull. Jap. Soc. Sci. Fish.* 45(8): 983-987. (In Japanese with English abstract.)
- Takeuchi, T., T. Watanabe and C. Ogino. 1979. Digestibility of hydrogenated fish oils in carp and rainbow trout. *Bull. Jap. Soc. Sci. Fish.* 45(12): 1521.
- Tamas, G. and L. Horvath. 1979. Fry and fingerlings production under pond farm management conditions (carp and other cyprinids). EIFAC Tech. Pap. 35, Suppl. 1: 53-58.
- Vanhaeckhe, P. and P. Sorgeloos. 1980. International study on *Artemia*. IV. The biometrics of *Artemia* strains from different geographical origin, p. 393-405. *In* G. Persoone, P. Sorgeloos, O. Roels and E. Jaspers (eds.) *The brine shrimp Artemia*, Vol. 3. Ecology, culturing, use in aquaculture. Universa Press, Wetteren, Belgium.
- Van Limborgh, C.L. 1979. Industrial production of ready-to-use feeds for mass rearing of fish larvae, p. 3-11. *In* J.E. Halver and K. Tiews (eds.) *Finfish nutrition and fishfeed technology*, vol. II. Heenemann Verlagsgesellschaft mbH, Berlin.
- Viola, S. 1975. Experiments on nutrition of carp growing in cages. 2. Partial substitution of fishmeal. *Bamidgeh* 27(2): 40-48.
- Viola, S. and U. Rappaport. 1979. The 'extra-caloric' effect of oil in the nutrition of carp. *Bamidgeh* 31(3): 51-68.
- Von Lukowicz, M. 1979b. Experiences with krill (*Euphausia superba* Dana) in the diet for young carp (*Cyprinus carpio* L.), p. 293-302. *In* J.E. Halver and K. Tiews (eds.) *Finfish nutrition and fishfeed technology*, vol. II. Heenemann Verlagsgesellschaft mbH, Berlin.

CHAPTER 9. DISEASES OF CULTURED CARPS

- Amlacher, E. 1970. Textbook of fish diseases. D.A. Conroy and R.L. Herman (trans.). T.F.H. Publications, Neptune City, New Jersey.
- Bucke, D. 1972. Some histological techniques applicable to fish tissues, p. 153-189. *In* L.E. Mawdesley-Thomas (ed.) *Diseases of fish*, Proceedings of symposium no. 30, Zoological Society, London, May 1971. Academic Press and the Zoological Society, New York and London.
- Budd, J. and R.J. Roberts. 1978. Neoplasia of teleosts, p. 105-113. *In* R.J. Roberts (ed.) *Fish pathology*. Baillière Tindall, London.
- Bullock, G.L. 1971. Diseases of fishes. Book 2B. Identification of fish pathogenic bacteria. T.F.H. Publications, Neptune City, New Jersey.
- Bullock, G.L., S.F. Snieszko and D.A. Conroy. 1971a. Diseases of fishes. Book 2A. Bacterial diseases of fishes. T.F.H. Publications, Neptune City, New Jersey.
- Cheong, L., R. Chou, R. Singh and C.T. Mee. 1983. Singapore, p. 47-63. *In* *Fish quarantine and fish diseases in Southeast Asia: report of a workshop held in Jakarta, Indonesia, 7-10 December 1982*. International Development Research Centre, Ottawa, Canada.
- Cowey, C.B. and R.J. Roberts. 1978. Nutritional pathology of teleosts, p. 216-226. *In* R.J. Roberts (ed.) *Fish pathology*. Baillière Tindall, London.
- Davy, B. and M. Graham, editors. 1979. Diseases of fish cultured for food in Southeast Asia: report of a workshop held in Cisarua, Bogor, Indonesia, 28 November-1 December 1978. International Development Research Centre, Ottawa, Canada.
- Djajadiredja, R., T.H. Panjaitan, A. Rukyani, A. Sarono, D. Satyani and H. Supriyadi. 1983. Indonesia, p. 19-30. *In* *Fish quarantine and fish diseases in Southeast Asia: report of a workshop held in Jakarta, Indonesia, 7-10 December 1982*. International Development Research Centre, Ottawa, Canada.
- Dogiel, V.A., G.K. Petrushevski and Y.I. Polyanski, editors. 1970. Parasitology of fishes. Z. Kabata (trans.). T.F.H. Publications, Neptune City, New Jersey.

- Fijan, N. 1981. Vaccination of fish in European pond culture: prospects and constraints. *Fish Health News* 10(1): 70-81.
- Ghittino, P. 1979. International aspects of disease control in aquaculture, p. 92-98. *In* T.V.R. Pillay and W.A. Dill (eds.) *Advances in aquaculture*. Fishing News Books Ltd., Farnham, Surrey, England.
- Gordon, M. 1953. The genetics of fish diseases. *Trans. Amer. Fish. Soc.* 83: 229-240.
- Griffin, P.J. 1954. The nature of bacteria pathogenic to fish. *Trans. Amer. Fish. Soc.* 83: 241-253.
- Herman, R.L. 1970. Prevention and control of fish diseases in hatcheries, p. 3-15. *In* S.F. Snieszko (ed.) *A Symposium on diseases of fishes and shellfishes*. Special Publication No. 5. American Fisheries Society, Washington, D.C.
- Horvath, L., M. Lang and G. Tamas. 1978. The use of copper oxychloride during larval growth as a preventive measure against the spread of ciliate exoparasites. *Bamidgeh* 30(3): 80-84.
- Kabata, Z. 1970. *Diseases of fishes. Book 1. Crustacea as enemies of fishes*. T.F.H. Publications, Neptune City, New Jersey.
- Kabata, Z. 1985. *Parasites and diseases of fish cultured in the tropics*. Taylor and Francis Ltd., London.
- Kou, G-H., J.L. Fryer and M.L. Landoit, editors. 1981. *Proceedings of Republic of China-United States cooperative science seminar on fish diseases*. National Science Council, Taipei. (Contains useful reviews on diagnosis, chemotherapy and warmwater pathogens.)
- Liversidge, J. and A.L.S. Munro. 1978. The virology of teleosts, p. 114-143. *In* R.J. Roberts (ed.) *Fish pathology*. Baillière Tindall, London.
- Lucky, Z. 1981. An investigation of invasive diseases of the fry of herbivorous fishes and their treatment. *Fish Health News* 10(1): 259-269.
- Mawdesley-Thomas, L.E., editor. 1972. *Diseases of fish, Proceedings of symposium no. 30*. Zoological Society, London, May 1971. Academic Press and the Zoological Society, New York and London.
- McDaniel, D.W., editor. 1979. *Fish health blue book. Procedures for the detection and identification of certain fish pathogens*. Fish Health Section, American Fisheries Society, Bethesda, Maryland. (An excellent handbook for diagnostic procedures.)
- Needham, T. and R. Wootten. 1978. The parasitology of teleosts, p. 144-182. *In* R.J. Roberts (ed.) *Fish pathology*. Baillière Tindall, London.
- Olah, J., K. Molnar and Z. Jeney, editors. 1981. *Fish, pathogens and environment in European polyculture: proceedings of an international seminar, 23-27 June 1981, Szarvas, Hungary*. *Fish Health News* 10(1): 527 p.
- Post, G.W. 1983. *Textbook of fish health*. T.F.H. Publications, Neptune City, New Jersey.
- Poupard, C.J. 1978. Therapy of fish diseases, p. 268-275. *In* R.J. Roberts (ed.) *Fish pathology*. Baillière Tindall, London.
- Rabanal, H.R. 1978. International traffic of live fish and fish eggs and control of the spread of fish diseases: contribution to the workshop on tropical fishes diseases—their causes and control in Southeast Asia, Puncak, West Java, Indonesia, 28 November to 1 December 1978. FAO/UNDP, South China Sea Development and Coordinating Programme, Manila.
- Reichenbach-Klinke, H. and E. Elkan. 1965. *Diseases of fishes. Book 2. Diseases of lower vertebrates*. Academic Press, New York.
- Ribelin, W.E. and G. Migaki, editors. 1975. *The pathology of fishes*. University of Wisconsin Press, Madison, Wisconsin.
- Richards, R.H. 1978. The mycology of teleosts, p. 205-215. *In* R.J. Roberts (ed.) *Fish pathology*. Baillière Tindall, London.
- Richards, R.H. and R.J. Roberts. 1978. The bacteriology of teleosts, p. 183-204. *In* R.J. Roberts (ed.) *Fish pathology*. Baillière Tindall, London.
- Roberts, R.J., editor. 1978. *Fish pathology*. Baillière Tindall, London.
- Roberts, R.J. 1978. Miscellaneous non-infectious diseases, p. 227-234. *In* R.J. Roberts (ed.) *Fish pathology*. Baillière Tindall, London.
- Rogers, W.A. and J.L. Gaines, Jr. 1975. Lesions of protozoan diseases in fish, p. 117-141. *In* W.E. Ribelin and G. Migaki (eds.) *The pathology of fishes*. University of Wisconsin Press, Madison, Wisconsin.
- Rohovec, J. 1979. Review of international regulations concerning fish health, p. 7-9. *In* *Proceedings of a conference on disease inspection and certification of fish and fish eggs*. ORESU-W-79-001. Oregon State University Sea Grant College Program, Corvallis, Oregon.

- Sarig, S. 1961. Carp diseases, their prevention and treatment. Proc. Gen. Fish. Council. Medit. 6: 107-212.
- Sarig, S. 1966. A review of diseases and parasites of fishes in warm water ponds in the Near-East and Africa. FAO Fish. Rep. 44(5): 278-289.
- Sarig, S. 1968. Possibilities of prophylaxis and control of ectoparasites under conditions of intensive warm water pond fish culture in Israel. Bull. Off. Int. Epiz. 68(9/10): 1577-1590.
- Sarig, S. 1971. Diseases of fishes. Book 3. The prevention and treatment of diseases of warm water fishes under subtropical conditions, with special emphasis on intensive fish farming. T.F.H. Publications, Neptune City, New Jersey.
- Shepherd, C.J. 1978. Husbandry and management in relation to disease, p. 276-282. In R.J. Roberts (ed.) Fish pathology. Baillière Tindall, London.
- Shotts, E.B. and G.L. Bullock. 1975. Bacterial diseases of fishes: diagnostic procedures for gram-negative pathogens. J. Fish. Res. Board Can. 32: 1243-1247.
- Sindermann, C.J. 1970. Principal diseases of marine fish and shellfish. Academic Press, New York.
- Snieszko, S.F. 1970. Immunization of fishes: a review. J. Wildl. Dis. 6: 24.
- Snieszko, S.F. 1972. Nutritional fish diseases, p. 404-437. In J.E. Halver (ed.) Fish nutrition. Academic Press, New York.
- Snieszko, S.F. 1974. The effects of environmental stress on outbreaks of infectious diseases in fishes. J. Fish. Biol. 6: 197-208.
- Thompson, P.E., W.A. Dill and G. Moore. 1973. Major communicable fish diseases of Europe and North America: a review of national and international measures for their control. EIFAC Tech. Pap. 17, Suppl. 1, 48 p.
- Van Duijn, C. 1956. Diseases of fishes. Water Life, London.
- Vaughan, G.E. and D.W. Coble. 1975. Sublethal effects of ectoparasites on fish. J. Fish Biol. 7: 283-294.
- Williams, H.H. 1967. Helminth diseases of fish. Helminthol. Abstr. 36: 261-295.
- Wolf, K. 1964. Characteristics of viruses found in fishes. Dev. Ind. Microbiol. 5: 140-148.
- Wolf, L. 1954. Development of disease-resistant strains of fish. Trans. Amer. Fish. Soc. 83: 342-349.

Appendix

II

Useful Technical Periodicals

Title and Publishers	Issues	Annual Subscription
<p>Aquacultural Engineering Elsevier Applied Science Publishers Ltd. Crown House, Linton Road Barking, Essex IG11 8JU England</p>	<p>Quarterly issues; making one volume per year</p>	<p>£58.00, overseas £72.00 (unit postage and packing)</p>
<p>Aquaculture Elsevier Science Publishers B.V. Journal Division P.O. Box 211 1000 AE Amsterdam The Netherlands</p>	<p>Four issues per volume</p>	<p>Dfl. 1,448.00 (Approx US\$589.00) varies each year</p>
<p>Aquaculture and Fisheries Management (Formerly Fisheries Management) Blackwell Scientific Publications Ltd., P.O. Box 88 Oxford, England</p>	<p>Begins with Vol. 16, no. 1 (January 1985); Quarterly</p>	<p>£60.00 (UK), £72.00 (Overseas); (USA and Canada) post free</p>
<p>Aquaculture Magazine (Formerly the Commercial Fish Farmer and Aquaculture News) Subscription Dept. P.O. Box 2329 Asheville, North Carolina 28802 U.S.A.</p>	<p>Bimonthly; with extra issue in November</p>	<p>US rate, US\$15.00 per year; other countries US\$19 per year</p>
<p>Bamidgeh. Quarterly on Aquaculture in Israel Israel Ministry of Agriculture Fisheries Department Hakiriah, Tel-Aviv Israel</p>	<p>Quarterly</p>	<p>US\$4.00</p>
<p>Fish Farmer Subscription Manager Oakfield House Perrymount Road, Haywards Heath Sussex RH 15 3DH, England</p>	<p>Six times a year</p>	<p>UK, £25.00; other countries £30.00 (all inclusive of postage and packing)</p>

Title and Publishers	Issues	Annual Subscription
Fish Farming International AGB Heighway Ltd. Heighway House 87 Blackfriars Road London SE1 8HB United Kingdom	Monthly	UK and surface mail to other countries, £12.00
ICLARM Newsletter International Center for Living Aquatic Resources Management MCC P.O. Box 1501 Makati, Metro Manila, Philippines	Quarterly	Free to individuals and institutions in developing countries by surface mail
Progressive Fish-Culturist American Fisheries Society 5410 Grosvenor Lane Suite 110, Bethesda Maryland 20014 U.S.A.	Quarterly	\$12.50 (U.S.A.) \$15.00 (all other countries)

Appendix III

Some Asian Units and Their Metric Equivalents

BANGLADESH AND PAKISTAN

Weight		Metric equivalent (grams)
1 Maund	=	37,324
1 Seer	=	933
1 Chhatak	=	58
1 Tola	=	11.66
Area		(square meters)
1 Bigha	=	1,338
1 Katha	=	66.87

BURMA

Weight		(grams)
1 Viss	=	1,633
1 Tical	=	16.33
1 Ywegyi	=	0.272
1 Ywelay	=	0.136
Volume		(liters)
1 Tin	=	40.914
1 Kiwe	=	2.046
1 Sate	=	1.023
1 Pyis	=	0.256
1 Khwet	=	0.128
1 Sale	=	0.064
1 Lahme	=	0.032
1 Lamyet	=	0.016
1 Lamyu	=	0.008
Length		(meters)
1 Yuzan	=	20,482.56
1 Ghaweot	=	5,120.24
1 Kawtha	=	1,280.16
1 Ohtethapha	=	64.008
1 Tar	=	3.200
1 Lav	=	1.829
1 Taung	=	0.457
1 Htwa	=	0.223
1 Mike	=	0.152
1 Letthit	=	0.019
1 Muyaw	=	0.005
1 Nham	=	0.001
1 Sanchi	=	0.00008

CHINESE UNITS (USED THROUGHOUT ASIA)

Weight		(grams)
1 Picul (Tam)	=	60,479
1 Old Catty (Kan)	=	604.79
1 New Catty*	=	500
1 Leung (Tael)	=	37.799
Area		(square meters)
1 DauChung	=	674.476 (nominally 1/6 of an acre)
1 Mu	=	670
Length		(meters)
1 Chek (Chinese foot)	=	0.3715
1 Tsun (Chinese inch)	=	0.03715

NEPAL

Weight		(grams)
1 Maund (equivalent to 40 seers)	=	37,324
1 Doko	=	15,000
1 Seer	=	933
1 Dharni	=	2,500
1 Pav	=	233
1 Chhatak	=	58
1 Tola	=	11.66
Area		(square meters)
1 Ropni	=	500
1 Katha	=	333
1 Bigha	=	6,667
1 Dhur	=	16.5
Volume		(liters)
1 Moori	=	90.9
Length		(meters)
1 Gaj	=	0.9144

THAILAND

Weight		(grams)
1 Kiit	=	100
Area		(square meters)
1 Rai	=	1,600
1 Square Wah (talangwah)	=	4

*People's Republic of China

Geographical Index

The index includes continents, countries, rivers and lakes in alphabetical order.

- Africa, export of rohu 13
Amur R., U.S.S.R., silver carp 3
Asia, breeding seasons of cultured carps 41
 carp rearing, current feeding practices, tabulated 106
 hypophysation, only chance for fish farmers 50
 Majalayan strain of common carp for genetic selection 88
 mid-region, to find *Cyprinus carpio aralensis* 7
 units and metric equivalents 167-68
- Bangladesh, contents of supplementary feed at Raipur Hatchery 91
 hatching jars, figured 31
 losses of catla from myxosporidian parasites 123
 Raipur Carp Hatchery, details of arrangements, figured 34
 jar hatchery, figured 34
 plastic jars, figured 34
 units and metric equivalents 167
- Belgium, Artemia Reference Centre 103
 European Aquaculture Trade Directory 133
- Black Sea, distribution of common carp 7
- Bombay, Central Institute of Fisheries Education 33
- Burma, rivers of habitat of rohu 13
 units and metric equivalents 167
- Caspian Sea, distribution of common carp 7
- Cauvery R., India, transplantations of catla 10
- Chaplin Bay, Canada, source of Artemia cysts 102
- China, Amur-Chinese region, habitat of *Cyprinus carpio haematopterus* 1
 first maturity of common carp 9
 grass carp, in flatland rivers 1
 size and age at first maturity 4
 growth rate of common carp 9
 growth rate of grass carp 3
 stunting of bighead, grass and silver carps 73
 training Chinese carp broodfish 41
 use of HCG for breeding bighead, silver and grass carps 50
- Cuttack, India, glass jar hatchery 32
- England, breeding period of common carp 55
 growth rate of common carp 9
- Europe, diversity of high performance strains and hybrids 88
 first maturity and growth of common carp 9
- European-Transcaucasian, area to find *Cyprinus carpio carpio* 7
- Ganga R., India, growth of mrigal 17
 spawning of mrigal 19
- Germany, use of Galician mirror carp 88
- Godavari R., India, spawning of mrigal 19
- Great Salt L., U.S.A., source of Artemia cysts 102
- Greece, distribution of common carp 8
- Halda R., India, spawning of mrigal 19
- Hong Kong, ratio of weights of donor and recipient fish equated for bighead, silver and grass carps 54
- Hungary, derivation of cultured carps 88
 growth rate of grass carp 3
 heavy losses of fingerlings caused by myxosporidians 126
 mass production of gynogenetic carp ova 89
 occurrence of hemorrhagic septicaemia 121
- India, *Bati* used for measurement 69
 Central Inland Fisheries Research Institute, Cuttack Pond Culture Division 5
 classification of ponds in contents of available phosphorus and nitrogen, listed 66
 control of phytoplankton blooms 66
 Cuttack, glass jar hatchery, figured 32
 fecundity of common carp 10
 first maturity of common carp 9
 first maturity, size and age of grass carp 4
 growth rate of grass carp 3
 hapa, for breeding 57
 Khutela Bhata Fish Seed Farm, "Dwivedi" hatchery, figured 33
 spawning of mrigal, tabulated 19
 use of baked clay hatchery jars 31
 use of *Hydrilla* and *Najas* vegetation in breeding 57
- Indonesia, *Anodonta* glochidia infect fish gills 125
 breeding period of common carp 55
 development of mass culture of rotifers 59
 first maturity and growth rate of common carp 9

- semi-controlled breeding system 55
- serious diseases introduced because of lack of quarantine measures 127
- serious loss in hatchery production caused by *Lernaea cyprinacea* 126
- severe outbreak of bacterias carp disease in 1980 120
- training courses in fish diseases 127
- Israel, first maturity of common carp 9
- growth rate of common carp 3
- occurrence of fish pox 119
- Japan, export of rohu 13
- exports of Indian major carp seed 11
- first maturity of common carp 9
- German mirror carp out-performing local strain 89
- Kali R., India, spawning of mrigal 19
- Karnafuli R., India, spawning of mrigal 19
- Kossi Khanua Dhar R., India, spawning of mrigal 19
- Krishna R., India, spawning of mrigal 19
- Kwangsi R., China, "big-belly carp" 8
- bighead carp 6
- silver carp 3
- Kwangtung R., China, "big-belly carp" 8
- bighead carp 6
- silver carp 3
- Lavakluc, France, source of Artemia cysts 102
- Macau, Brazil, source of Artemia cysts 102
- Mahanadi R., India, natural source of rohu 13
- Malacca, growth rate of grass carp 3
- Malaysia, effect of bioassayed salmon gonadotropin on carps 54
- export of rohu 13
- exports of Indian major carp seed 11
- first maturity and growth of common carp 9
- first maturity, size and age of grass carp 4
- use of HCG in induced breeding of silver and bighead carps 50
- Margherita di Savoia, Italy, source of Artemia cysts 102
- Mauritius, transplantations of rohu 13
- Narmadi R., India, natural source of rohu 13
- Nepal, export of rohu 13
- exports of Indian major carp seed 11
- rivers, distribution of rohu 13
- units and metric equivalents 168
- Pakistan, units and metric equivalents 167
- Panchet reservoir, spawning of mrigal 19
- Philippines, exports of Indian major carp seeds 11
- export of rohu 13
- Poland, use of Galician mirror carp 88
- Powai L., Bombay, transplantations of rohu 13
- Raipur, Fish Hatchery and Training Centre 27
- Rantjapaku, method of semi-controlled breeding 55
- Rome, distribution of common carp 8
- Rumania, growth rate of grass carp 3
- San Francisco Bay, U.S.A., source of Artemia cysts 102
- Scotland, Institute of Aquaculture 118
- Shark Bay, Australia, source of Artemia cysts 102
- Siberia, growth rate of grass carp 3
- Southern Rhodesia, exports of Indian major carp seeds 11
- Sri Lanka, transplantation of rohu 13
- transplantations of common carp 10
- Taiwan, sieves for grading Chinese carp 71
- first maturity, size and age of grass carp 4
- Tapti, R., India, natural habitat of rohu 13
- Thailand, first maturity and growth rate of common carp 9
- ratio of weights of donor and recipient fish equated for bighead, silver and grass carp 54
- units and metric equivalents 168
- use of pituitary gland from *Tachysurus* sp. and *Trichogaster pectoralis* 50
- Tientsin, China, source of Artemia cysts 102
- Tilaiya reservoir, spawning of mrigal 19
- Tone R., India, fecundity of silver carp 5-6
- Turkmenia, growth rate of grass carp 3
- U.S.A., fertilizer mixture for ponds in Alabama 66
- first maturity of common carp 9
- U.S.S.R., development of carp for colder conditions and short growing seasons 88
- export of rohu 13
- exports of Indian major carp seeds 11
- first maturity of common carp 9
- first maturity, size and age of grass carp 4
- Vietnam, north region to find *Cyprinus carpio viridiviolaceus* 7
- West R., China, bighead carp 6
- growth of grass carp 3
- silver carp 3
- Yamuna R., India, age of catla at first maturity 11
- growth of mrigal 17
- spawning of mrigal 19
- Yangtze R., China, bighead carp 6
- "long bodied carp" 8
- silver carp 3
- Yugoslavia, derivation of carps cultured 88

Subject Index

Includes the carp genera and species. For continents, countries, rivers and lakes, see the Geographical Index.

- Abnormal conditions, and diseases 126
- Acanthocephalans 124-25
- Acclimatization, of Chinese carp 82
 - of Indian major carp 82
- Acetone-dried pituitary extract, use of 50
- Acetone-drying, of pituitary glands 46
- Achlya*, and diseases of eggs 126
 - examination and treatment, summarized 126
- Acriflavin, use in ante-tanks 36
 - used as a prophylactic 118
- Additive genetic variance, in selective breeding programs 84
- Adult carps, stages of maturity 43
- Aeromonas*, examination and treatment, summarized 129
 - and infectious dropsy 120
 - and ulcerative skin conditions 120
- Aeromonas punctata*, cause of hemorrhagic septicaemias 120
- Aeromonas salmonicida*, causes furunculosis in salmonids 120
- Aeschnidae*, predators on spawn 67
- Aflatoxins 126
- Age at first maturity, in Chinese carp 3
 - in silver carp 4-5
- Agrionidae*, predators on spawn 67
- Aischgrunder carp, hybridization of 88
 - suitability to ponds and climate 88
 - variety of common carp 8
- Alcohol, preservation of pituitary gland 45-46
- Algae, blue-green, cell wall digestion by tilapias 92-93
 - causing oxygen depletion in ponds 71
 - Dunaliella tertiolecta*, as poor culture for rotifers 101
 - Isochrysis galbana*, as good culture for rotifers 101
- Algal blooms, to control weeds in rearing ponds 71
- Algal mats, to control weeds in rearing ponds 71
- Alimentary canal, in bighead carp 7
- Ammonia gas, anhydrous, as a means of weed control in rearing ponds 71
- Ammonium sulphate, in fertilizer mix 66
- Analysis, of feed 109-14
- Anesthetics, use of, during injections 48
 - use of, during live fish transport 78-80
 - use of MS222 in hypophysectomy of common carp 57
- Anesthetizing chemicals, for collection, preservation and storage of pituitary glands 134
 - for collection and transport of broodstock 134
- Anodonta woodiana*, glochidia infect fish gills in Indonesia 126
- Ante-tanks 27-26
 - use 28
 - use of antiseptics 36
- Anthelmintics 124-25
- Antibiotics, and bacterial diseases 120
 - use of terramycin 121
 - use in treatment of diseases, summarized 129
 - used in virus testing procedures 132
- Antiseptics, use in ante-tanks 36
- Apparatus, laboratory, needed for hatchery 136-37
- Applicators, needed in hatchery 137
- Aquaculture, careful choice of stock 83
 - consult the Buyer's Guide for use of drugs 118
 - economics of 82
 - growth of mrigal 17
 - growth rate of bighead carp 7
 - importance of pond chemistry 21
 - management practice, "indirect selection" 81
 - specialist companies related to disease prevention, named 117
 - see also hatchery
- Aquatic weeds, preferred by grass carp 2
- Aquavet (chelated copper), and trichodinosis 122
- Arenga pinnata*. See *Indjuk* plant
- Arenga saccharifera*. See *Indjuk* plant
- Argent (copper control) and trichodinosis 122
- Argentine, an iodophor disinfectant 117
- Argulus*, life cycle 125
 - mortality of fry 126
 - parasitic copepod 125
 - treatment 125
- Aristichthys nobilis* 1. See also bighead carp
- Artemia cysts, bioeconomical evaluation of, tabulated 102
 - catch characteristics used to rear postlarvae of common carp 102
 - introduction into seawater 103
 - method of decapsulation 103

- Artemia nauplii*, as starter feeds 101-3
 Artemia Reference Centre in Belgium 103
 Artificial feeds, for common, Chinese and Indian major carps 69
 for common carp hatchlings 59-60
 for fingerlings 71, 107-9
 for fry 107-9
 for postlarvae 107-9
 Artificial food, analyses of food-yeast and fish meal, compared 106
 Artificial insemination. *See* stripping
 Asagi, Japanese race of common carp 8
 information, summarized 89
 Asia, breeding seasons of cultured carps 41
 carp rearing, current feeding practice, tabulated 106
 hypophysation, only hope for farmers 50
 Malayan strain of common carp, for genetic selection 86
 Asphalt liners, used in hatchery ponds 20
 Avitaminoses, in carps 96
- Bacillariophyceae, food for bighead carp 6
 food for silver carp 5
 Bacteria, role in digestion 91
 Methanophilic, as feed for fingerlings 109
 Bacterial diseases, *Aeromonas* spp. 120
 columnaris disease 121
 erythrodermatitis 120-21
 in fish, most pathogens gram-negative 120
 hemorrhagic septicaemia 121
 identification and treatment, summarized 128
 use of kanamycin sulphate 120
 Bacterial infections, during injection and stripping 47
 Bamboo poles, to remove weeds in rearing ponds 71
Barringtonia accutata, as fish toxicant in ponds 64
 Basic requirements for a selective breeding program 85
Bassia mahua. *See* mahua
 Baths, term, defined 117
Bati, measurement cup in India 69
 Baytex, selective action on rotifers and crustaceans 59
 used to control insect predators in ponds 68
Belostomatidae, predators on spawn 67
 Benthic organisms, food of common carp 8
 Benzalkonium chloride, used as a disinfectant 117
 Benzene hexachloride, an isomer of, used to control insect parasites in ponds 67
 treatment for *Argulus* 125
 "Big belly carp", in Kwantung river 8
 race of Chinese carp, showing hybrid vigor 84
 summary information 89
 Bighead carp 6-7
 age at first maturity 7
 alimentary canal 7
 dietary care of broodfish 41
 dilution of drugs used for transport 79
 distribution 6
 figured 6
 food of adults 6
 food of fry 6
 food of larvae 6
 growth rate in aquaculture 7
 hemorrhagic septicaemia 121
 Lernaea piscinae can kill fish 126
 limited information on crosses with Chinese, silver, grass, black and common carp 90
 little known of growth rate in rivers, of natural occurrence 7
 ratio of weight of donor and recipient fish equated, in Hong Kong and Thailand 54
 size at first maturity 7
 spawning 7
 stunting of, in China 73
 use in polyculture systems 82
 use of HCG in induced breeding in China and Malaysia 50
 zooplankton feeder 6, 40
 Biochemical oxygen demand. *See* B.O.D.
 Biological control, of weeds in rearing ponds 71
 Biology and genetics, research problems, listed 139-40
 Biology research problems, studies on farming grown fish 139
 studies on riverine stocks of fish 139
 Birds, control of, in ponds 68
 destructive to postlarvae 68
 Black carp, limited information on crosses with Chinese, silver, bighead, grass and common carp 90
 Blood flukes 123-24
 life cycle, summarized 124
 Blooms, undesirable consequences of, in tanks 99
 Blue-green algae, cause oxygen depletion in ponds 71
 B.O.D., rise of, in fertilization methods 66
 Bohemian carp, hybridization of 88
Bosmina. *See* cladocerans
Bothriocephalus acheilognathi (= *gawkongensis*), life cycle described 124
 Bottom dwelling organisms, food of common carp 8
Brachionus calyciflorus. *See* rotifer
Brachionus plicatilis. *See* rotifer
Branchiomyces, a serious pathogen 119
 examination and treatment, summarized 129
Branchiomyces demigrans, and gill rot 119
Branchiomyces sanguinis, in gill blood vessels 119
 Branchiomycosis, or gill rot 119
 Breeding, use of *Hydrilla* and *Najas* vegetation 57
 common carp 39, 55-58
 semi-controlled in common carp 55
 uncontrolled, of common carp 55
 uncontrolled, drawbacks, in common carp 55
 Breeding periods, of common carp, in Europe 55
 peaks of in common carp 54
 Breeding programs, selection of desired traits 84
 selective 84
 Breeding seasonality, of broodfish 42

- Breeding season(s), collection of pituitary gland 146
of cultured carps in Asia 4 i
- Breeding tanks 27-30
advantages of circular design 29
circular tank has some disadvantages 30
common features 28
figured 29-30
shape 28
size of circular tank 30
use of 28
use of *hapas* 28
- Bromex, and *Lernaea* infestations 125
safe dosage, discussed 124-25
treatment for *Argulus* 125
treatment for gill flukes 123
- Broodfish, breeding seasonality 42
care of 38-42
cloth bag for transport, figured 80
containers for transport 75, 77-78
dietary care of 41
equipment for collection, stripping and transport
133-34
feeding rate 41
feeds 41
husbandry 140
procedure to tranquilize 79
release of injected fish into tanks 48
requirements assumed in hatchery 24
should be anesthetized during transport 79
special care needed for catla brood 39-40
sources 38
training Chinese carp in China 41
- Broodfish care, maintenance tasks in Chinese carp and
Indian major carp 145-46
- Broodfish husbandry, research problems, listed 140
- Broodfish ponds 24-25
acceptable combinations of species in 39
characteristics of 38-40
essential component of a hatchery 22
fertilization and manuring 40
functions of 38
organic manures 40
ratios of different species in community pond,
listed 40
segregation of Chinese and Indian major brood-
stock 39
segregation of species 39
size and types of, in hatchery 38
structural features 25
use of Secchi disc to assess plankton production 40
- Broodstock, conditions when being held for certifica-
tion 130
feeds 114
health certification 130-32
husbandry and nutrition 115-16
information on supplemental feeds, tabulated 115
supplemental feeds 114
- BSS, Earle's Balanced Salt Solution 132
- Buffodine, an iodophor disinfectant 117
- Burning, as a means for weed control in rearing ponds 71
- "Buyer's Guide", Aquaculture magazine 133
- Calcium, requirements for carp 97-98
requirements for pond soils, listed 63
- Calcium carbonate (ground limestone), for liming 63-64
- Calcium hydroxide (slaked lime), for liming 64
- Calcium nitrate, in fertilizer mix 66
- Calcium oxide (quicklime), for liming 63-64. *See also*
quicklime
- Calophyllum inophyllum*, plant extract used to control
predatory insects in ponds 67
- Candida lipolytica*. *See* Alkan yeast
- Cannibalism, among young carp 61
- Carbohydrates, requirements of adult common carp and
cultured carp 96
diet of Dor 80 race, 96
- Care, of broodfish 38-42
of fish during induced breeding 47
- Carp hatchery. *See* Hatchery
- Carps, avitaminoses 96
cannibalism among young fish 61
classification and nomenclature 1
diseases 117-32
external features of sexes, listed 44
genetics of cultured fish 81-90
leeches, affect on 126
optimum temperature for growth 93
pituitary gland homogenized, figured 47
requirements of calcium 97-98
stages of gonadal maturity, listed 44
stocking of 71
vitamin deficiency symptoms 96
- Carp species, acceptable combinations of species in
broodfish ponds 39
ratios of, in community broodfish ponds 40
segregation of, in broodfish ponds 39
- Caryophyllaeus fimbriceps*, parasitic cestode 124
- Catchability, as a basic requirement for selective breed-
ing 85
- Catfish, as predators in ponds 61
- Catla 10-13
age at first maturity 11
age at first maturity in ponds 11
dietary care of broodfish 41
dissected to show pituitary gland, figured 45
distribution 10
fecundity 11-12
feed for hatchlings 70
figured 10
food of juveniles and adults 11
growth rate 11-12
hybridization trials 90

- length at first maturity 11
- myxosporidian parasites 123
- packing density, for ad and fingerlings 77
- phenomenon of golden . . . 90
- protocol for pituitary injections to induce spawning 54
- recipient female being weighed, figured 47
- spawning season 12
- special care needed for broodstock 39-40
- transplantations 10
- zooplankton feeders 7, 40
- Catla catla* 1. *See also* Catla
- Catlocarpio siamensis*, often confused with catla 10
- Cattle manure, doses for manuring ponds 65
- CE, *see* erythrodermatitis and carp erythrodermatitis
- Cell cultures, use in virus testing procedures 132
- Central Institute of Fisheries Education, Bombay, Dr. Dwivedi's portable hatchery 33
- Central Sumatra method of breeding common carp 56
- Ceratophyllum*, used in Chinese system of breeding 57
 - control of, in rearing ponds 71
 - food of grass carp 2
- Ceriodaphnia*, food of common carp 8
- Cestode infestations, quarantine measures essential 124
- Cestodes, life cycle, described 124
 - symptoms of infestations 124
 - treatment for infestations 124-25
- Cestodes and acanthocephalans 124-25
- Chondrococcus*, examination and treatment, summarized 129
- Channa* spp. *See* Murrels
- Chara*, food of grass carp 2
- Chelated copper (Aquavet) and trichodinosis 122
- Chemicals, needed in hatchery 127
- Chemotherapy, few procedures standardized 117
 - general ground rules 118
- Chicken egg, as artificial food for common carp hatchling 59-60
 - nutrient composition, tabulated 104
- Chilodonella*, and trichodinosis 122-23
- Chinese and Indian major carps, hatchery maintenance tasks, listed 149
 - laboratory upkeep tasks, listed 149
 - post-stocking operations in nursery ponds 148
 - preparation of rearing ponds 149
 - pre-stocking operations in nursery ponds 147-49
 - segregation of, in broodfish ponds 39
- Chinese big belly, figured 87
- Chinese carp acclimatization of 82
 - anesthetizing drugs for transport 79
 - artificial feeds for postlarvae 69
 - breeding seasons in Asia 42
 - feeds and feeding rates for fry and fingerlings, listed 73
 - fertilized eggs, figured 49
 - food organisms preferences, tabulated 99
 - genetics of 89-90
 - hatching jars in use, figured 32
 - induced breeding techniques, listed 51-53
 - induced spawning 43-60
 - limited information on crosses with other carp 90
 - maintenance tasks 145-49
 - maintenance tasks for care of broodfish 145-46
 - maintenance tasks for care of spent fish 145-46
 - maintenance tasks for induced breeding 146-47
 - microzooplankton diet 98
 - no data of commercial traits 90
 - protocol for induced spawning 51-53
 - receiving little attention from geneticists 81
 - sieves used for grading, in Taiwan 71
 - training broodfish, in China 41
 - see also* silver, bighead, grass carps
- Chinese common carp, hybridizes with Japanese and European races 84
- Chinese system of breeding 57
 - use of weeds 57
- Chinese units, and metric equivalents 168
- Chironomid larvae, food of common carp 8
- Chloramine T, used as a disinfectant 117
- Chloromycetin, and columnaris disease 121
- Chromosome manipulation 85-86
- Chydorus*, food of common carp 8
- Ciliate protozoan, infestations 122-23
- Circular breeding tanks 28-30
 - figured 30
- Circular cement tanks, merits and demerits for hatching 35
- Circular tanks 28-30
 - advantages 29
 - convenient size for breeding 30
 - disadvantages for breeding 30
 - modular design, figured 29
 - waterflow 30
- Cirrhinus mrigala* 1. *See also* mrigal
- Cladocera, culture for feed 105-6
 - feed for carp fry beyond starter diet 105-6
 - feed for fry 101
 - food of grass carp 2
 - food of silver carp 5
 - genera, cultured for feed 105
- Clarias* spp. *See* catfish
- Classification of carps 1
- Clay jars for hatching, figured 31
- Climate, suitability of Aischgrunder mirror carp 88
- Clomiphene citrate, as an ovulatory agent 54
- Closed system, for transporting live fish 74
- Closterium*, food of common carp 8
- Coconut, in artificial feed for fingerlings 71
 - oil, to control predatory insects in ponds 67
- Coenagrionidae*, predators on spawn 67
- Cold shocking, during gynogenesis 86
- Collection, equipment for broodfish 133-34
 - equipment for collection of pituitary glands 134
- Coiocasia*, control of, in rearing ponds 70

- Color, as a basic requirement for selective breeding 85
- Columnaris, examination and treatment, summarized 129
- Columnaris disease 121
 - caused by *Flexibacter columnaris* 121
 - symptoms and treatment 21
- Common carp, acetone-dried pituitary extract, use of 50
 - anesthetizing drugs, for transport 79
 - artificial feeds for postlarvae 69
 - availability of phosphorus in feed, tabulated 97
 - behavior of hatchlings 59
 - as benthic omnivore 93
 - blood fluke 123
 - breeding 39, 55-58
 - breeding peaks 54
 - breeding period in Europe and Indonesia 55
 - breeding season in Asia 42
 - carbohydrate requirement of adult 96
 - care of eggs during controlled breeding 57-58
 - cestode infestations 124
 - Chinese race, response to environment 89
 - controlled breeding 57-58
 - criteria for choice of "big belly" variety for semi-controlled breeding 55
 - dietary care of broodfish 41
 - dig into pond embankments 8
 - distribution 7-8
 - diversity of strains reflecting long history of culture 87
 - domestication of 86
 - domestication of cultured stock 81
 - drawbacks of uncontrolled breeding 55
 - Dubisch method of breeding 57
 - essential amino acid requirements, summarized 194
 - European race response to environment 89
 - European system of semi-controlled breeding 57
 - expected yield of fry of female spawners 56
 - famous strains in Europe, summary of information 88
 - fecundity in India 10
 - feeding of hatchlings 59
 - figured 8
 - fish pox 119
 - food of fry and postlarvae 8
 - food organisms for fry, tabulated 99
 - four sub-species 7
 - fry 8
 - genetics 86-89
 - growth in different countries 9
 - growth of postlarvae/fry on various diets, figured 108
 - growth rate 9
 - gulp mud 8
 - hatchlings 59
 - hemorrhagic septicaemias 120
 - hybridization with Indian major carps 90
 - hypophysation 57
 - introduction to Southeast Asia 82
 - Japanese races 8
 - krill, as a protein source in meal 109
 - large size of testes 9
 - length at first maturity 9
 - limited information on crosses with other carps 90
 - lipid requirements of adult 95
 - live and artificial food for hatchlings 59-60
 - maintenance tasks 150
 - Majalayan strain for genetic selection 88
 - method to remove adhesiveness in eggs 57-58
 - mineral requirements of adults 97-98
 - nematode parasite 124
 - now a global fish 8
 - nutritional requirements of adult 93-98
 - parasitized by *Piscicola geometra* 126
 - powdered crude extract of pituitary 50
 - problems of nomenclature in selective breeding 87
 - production of triploids 89
 - Rantjapaku method of breeding 56
 - resistance and susceptibility to disease 119
 - SBI 118, 119
 - semi-controlled breeding 55
 - size and age at first maturity 9
 - some strains in Asia, summarized 89
 - spawning season 9
 - spring viraemia 117
 - Sundanese method of breeding 56
 - Sundanese method of semi-controlled breeding 55
 - Tjimindi method of breeding 56
 - trace elements, requirements of adults 97-98
 - ulcerative skin conditions 120
 - uncontrolled breeding 55
 - use of MS222 in controlled breeding 57
 - varieties, figured 87
 - varieties recognized by scale patterns 86
 - varieties and strains 8
 - vitamin requirements, of adult 94, 96
 - wild carp as a genetic resource 86
 - wild strains, information 88-89
- Community tanks or ponds 28
- Complete feed formulation 112-113
- Compost, doses for manuring ponds 65
 - use of water hyacinth 65
- Compost production, in hatchery 65
 - use of nitrate of soda and superphosphate of lime 55
- Conditioning, for fry before transfer 37
- Conditioning of fish for transport, containers for 74
 - period of 74-75
 - principle 74
 - site of 74
- Containers, for conditioning of fish for transport 75, 77
 - for transport of fingerlings and broodfish 75, 77-78
 - for transport of fish fry and fingerlings 75-76
- Contour survey, must precede hatchery construction 26
- Control, of predatory birds in ponds 68
- Controlled breeding, care of eggs in common carp 57-58

- Conversion ratios, grass carp feeds 3
- Copepod nauplii, food for silver carp 3
- Copepods, food of grass carp 2
 food of silver carp 5
 hosts in cestode life cycle 124-25
see also parasitic copepods
- Copper Control (Argent), and trichodinosis 122
- Copper oxychloride, and trichodinosis 123
- Copper sulphate, and columnaris disease 121
 use of in treatment of diseases, summarized 129
- Corrixidae*, predators on spawn 67
- Costia* (= *Ichthyobodo*), examination and treatment, summarized 128
- Costia necatrix*, and costiasis 122
- Costiasis, symptoms 122
 treatment 122
- Costs, worksheet for diet formulation 113
- C.P.E., cytopathic effect 132
- Craft, needed for hatchery 133-137
- Crossbreeding programs, in Hungary using inbred strains
 with sex inversion 89
- Croton tiglium*, as a fish toxicant in ponds 63
- Crustacean diseases, identification and treatment, summarized 128
- Crustaceans, action of organophosphates 59
- Cryptobia cyprini*, a blood parasite 126
- Ctenopharyngodon idella*, induced breeding techniques 52
see also grass carp
- Culture, of cladocerans for feed 105-6
 research problems 138-144
 tropical, of Majalayan strain 88
- Culture conditions, growth of catla 11
 growth of grass carp 3
 growth of rohu 14
- Cultured carps, breeding seasons in Asia, figured 42
 carbohydrate requirements 96
 genetics 81-90
 lipid requirements 95
 mineral requirements 97-98
 nutrition 91-114
 nutritional requirements 93-98
 trace elements requirements 97-98
 vitamin requirements of adult 96
- Cyclops, domestication of cultured stock 81
 food of common carp 8
- Cyprinids, as hosts in cestode life cycles 125
- Cyprinus carpio* 1, 39
aralensis, subspecies 7
carpio, subspecies 7
haematopterus, subspecies 7
 races showing hybrid vigor 83-84
 var. *communis*. *See* scale carp 8
 var. *flavipinnis* c.v. *See* Indonesian orange-colored carp 8
 var. *nudus*. *See* leather carp 89
 var. *specularis*. *See* mirror carp 8
- viridivio-laceus*, subspecies 7
see also common carp
- 2, 4-D, used to control weeds in rearing ponds 70-71
- Dactylogyrus*, examination and treatment, summarized 128
 and mortality of fry 126
- Dactylogyrus vasator*, gill fluke 123
- Daphnia. *See* cladocera
- Decapsulation, method for artemia cysts 103
- Degree days, and age at first maturity 3
- Deoxycorticosterone. *See* D.O.C.
- Derris powder, as a pond toxicant 62
- Description, grass carp 1-3
- Detritus, eaten by mrigal 16
- Diaphanosoma*, food of common carp 8
- Diatoms, food of common carp 8
- Diesel oil, used to control insect predators in ponds 68
- Diet, care of broodfish 41
 for common carp hatchlings 60
 composition of carp grower 92
 polyunsaturated fatty acids as essential dietary requirements 95
- Diet formulation. *See* feed formulation
- Digenetic trematodes 123-24
 metacercariae cysts 124
- Digestion, in grass carp 2
 role of in bacteria 91
- Dinnyés, Hungarian race of common carp 8
 high performance strain 88
- Dinoflagellata, food of bighead carp 6
 food for silver carp 5
- Dips, term, defined 117
- Dipterex, and *Lernaea* infestations 125
 used to kill copepod host in cestode infestations 125
- Dipterex, selective action on rotifers and crustaceans 59
 used to control insect predators in ponds 68
- Disease prevention in aquaculture, specialist companies, named 118
- Disease resistance, as a basic requirement for selective breeding 85
- Diseases of carps 117-38
 and acanthocephalans 124
 bacterial diseases 120-21
 a centre for advice, named 118
 and cestodes 124
 costiasis 122
 disinfectants 117-18
 of eggs 126
 fungal diseases 119-20
 gas bubble disease 127
 health certification 130-32
 infectious dropsy 118
 legislation and use of drugs 118

- methods for examination and treatment, summarized 131-32
- myxoboliasis 123
- myxosporidian parasites 123
- nematode parasites 124
- parasitic copepods 124-26
and parasitic helminths 123-25
- prevention, prophylaxis and treatment 117-18
- protozoan infections 121-23
- quarantine arrangements 127-30
- sanguinicoliasis 124
- spring viraemia of common carp 117
- training courses 127
- trichodinosis 122-23
of various sorts 126
viral diseases 118-19
- Disinfectants, used to prevent diseases 117-18
- Distribution of catla 10
of grass carp 1, 2
of mrigal 15
of rohu 13
of silver carp 3
- DOC, as an ovulatory agent 54
- Domestication of common carp 86
of common carp cultured fish 81
of cultured aquatic animals 81
to produce races, strains and varieties 86
of terrestrial livestock 81
- Donor fish, choice of, for pituitary gland collection 46
required weight of extract from pituitary gland 46
- Dor 70. *See* Israeli mirror carp
- Dor 80. *See* Israeli carp
- Dose recommended, for anaesthetics during transport 79
- "Double barrel" live-fish carrier 78
- Drag chains, to remove weeds in rearing ponds 71
- Draining, of nursery and rearing ponds 25
- Dressing weight, as a basic requirement for selective breeding 85
- Drugs, specialist companies, named 118
use, often controlled by legislation 118
used for anesthetizing during transport 79
- Drying, of feedstuffs for processing 114
- Dubisch method of breeding 57
- Duckweed, to control algal bloom 66
as food for grass carp fingerlings 109
- Dunaliella tertiolecta*. *See* algae
- Dwivedi, Dr. S.N., portable hatchery, described 33-34
portable hatchery, figured 33
- Dwivedi hatching system, merits and demerits 36
- Dytiscidae*, predators on spawn 67
- Earle's Balanced salt solution, and virus tests 132
- Economics of aquaculture 82
- Eggs, adhesive, in common carp 9
diseases 126
problems with naturally spawned and fertilized 58
of silver carp 5-6
stage, defined ii
- Eichhornia*, used in Chinese system of breeding 57
control of, in rearing ponds 70
- Eichhornia crassipes*. *See* water hyacinth
- Environment, judging suitability of, before stocking 68
- Environmental conditions, necessary for hypohysation 48
- Environmental stress, and columnaris disease 121
- Enzymes, lack of phytase in fish 97
- Epidermal epithelioma, symptoms 119
a viral disease in common carp 119
- Equipment needed, for fry rearing 135
for collection of broodfish 133
for collection of pituitary glands 134
for fertilization 134-35
for incubation 135
for postlarval rearing 135
for preservation and storage of pituitary glands 34
for transport of broodfish 133
for transport of fingerlings, fry and postlarvae 135-36
in the field 136-37
- Erythrodermatitis, caused by a bacterium 120
detected visually 131
treated with sulphonamide drugs 120
- Essential amino acids, worksheet for diet formulation 113
- Euglena*, food of common carp 8
- Euphausia superba*. *See* krill
- European Aquaculture Trade Directory 133
- European carps, hybrid vigor 84
- European common carp hybrid between Japanese and Chinese races 84
- European system, of semi-controlled breeding of common carp 57
- Exophthalmos, and sanguinicoliasis 124
- Exotic species of carp, sources of, for broodfish 38
- Fairy shrimps, eliminated by lime in ponds 68
- F.A.O., establishment of pituitary bank 50
- Farm grown fish, biology research problems 139
- Farm implements, needed for a hatchery 133-37
- Farming practices, genetic deterioration 81-82
- Featherbacks, *Notopterus chitala* as a predator in ponds 61
- Fecundity, as a basic requirement for selective breeding 85
of catla 11-12
figure assumed in hatchery design 24
of grass carp 3
in mrigal 18
of rohu 14-15
of silver carp 4-6
- Feed, for carp fry, beyond starter diets 105-6
cladoceran genera cultured 105
- Feed analysis 109-14

- Feed development, for fingerlings 109
- Feed formulation 109-14
- best-buy calculations 110-11
 - complete 112-13
 - crude protein levels 111-12
 - least-cost calculations 110-11
 - linear programming 113-14
 - selection of raw materials 110
- Feeding, advanced fingerlings in nursery ponds 106-7
- advanced fry in nursery ponds 106-7
 - of catla 11
 - of mrigal 16
 - nutritional overkill as a current practice 98
 - of postlarvae in ponds 69
 - rate of, for fingerlings 71
 - ratios in hatchery ponds 23
 - recommended size/length of live food organisms in starter feeds, tabulated 101
- Feeding habits, of fingerlings, fry and postlarvae 98-107
- Feeding practice, current, in Asia, tabulated 106
- Feeding rate, of broodfish 41
- Feeding regimes, of fry and postlarvae 99-100
- Feeding schedule, for fry and postlarvae 69
- Feeds, best for monoculture of rohu 70
- for broodfish 40-41
 - for broodstock 114
 - methanophilic bacteria as feeds for fingerlings 109
 - petroyeasts for fingerlings 109
 - procedure for formulation 112
 - single cell protein 109
 - worksheet for diet formulation, essential amino acids 113
 - major nutrients and costs 113
- Feedstuffs, drying of, for processing 114
- heat treatment of 114
 - milling of 114
 - processing 114
 - sizes of pellets 114
- Fertilization, of broodfish 40
- during induced breeding 48
 - equipment needed for 134-35
 - of nursery ponds for zooplankton production 64-65
 - of ponds 64-67
- Fertilizer mixture, for ponds in Alabama, U.S.A. 66
- Fertilizers, use of land vegetation 67
- bamboo frame forming enclosure, figured 67
- FHM cell cultures 132
- Field, equipment needed for 136-37
- Filters, in nursery ponds 26
- reverse flow filter, figured 26
- Fingerlings, artificial feeds for 71
- artificial feeds, trends in 107-9
 - best food for 64
 - containers for transport 75-76
 - equipment for transport 135-36
 - feed development 109
 - feeding habits 98-107
 - feeding of advanced fingerlings in nursery ponds 106-7
 - feeds and feeding rates for Chinese carps, listed 73
 - food in rohu 13
 - of grass carp, duckweed as food for 109
 - length of 71
 - losses caused by *Myxobolus* 126
 - myxosporidian infections can cause heavy losses 126
 - numbers of different species to produce a harvest of 100 t/year 23
 - numbers required in hatchery ponds 23
 - nutritional requirements 98-107
 - oxygen consumption of mrigal and rohu 75
 - packing density for catla 77
 - stage, defined ii
 - supplementary feeding 71-73
- First maturity, in bighead 7
- of catla 11-12
 - length in common carp 9
 - in mrigal 18
 - in rohu 14
 - size and age in silver carp 4
 - size in common carp 9
- Fish diseases 118-30. *See also* diseases
- Fishmeal, addition to supplemental feeds 70
- analysis of, compared with food yeast 108
- Fish pox 119. *See also* epidermal epithelioma
- in common carp 119
 - symptoms 119
- Flagellata*, food for bighead carp 6
- food for silver carp 5
- Flagellate protozoan infestation 122
- Flexibacter*, examination and treatment, summarized 129
- Flexibacter columnaris*, and columnaris disease 121
- Flukes. *See* blood flukes, gill flukes, skin flukes
- Flushes, term, defined 117
- Food, artificial, for common carp hatchlings 59-60
- best for postlarvae fry and fingerlings 64
 - fry of silver carp 3-4
 - grass carp 2 - live, for common carp hatchlings 59
 - silver carp 5
- Food and Agriculture Organization. *See* F.A.O.
- Forks, to remove weeds in rearing ponds 71
- Formalin, and ciliate infestations 122
- and costiasis 122
 - use, summarized 128
 - use as a disinfectant 118
 - used in quarantine procedures 128
 - treatment for gill flukes 123
 - and white spot disease 122
- Formulation of feeds 109-14
- Fry, artificial feeds, trends in 107-9
- best food for 64
 - cladocerans as feed beyond starter diets 105-6
 - of common carp 8

- of common carp, survival and weight, tabulated 102
- containers for transport 75-76
- equipment for transport 135-36
- expected yield of common carp 56
- feeding habits of 98-107
- feeding of advanced fry in nursery ponds 106-7
- feeding regimes 99-100
- feeds and feeding rates for Chinese carp, listed 73
- need for conditioning before transfer 37
- nutritional requirements 98-107
- organisms causing serious mortality, listed 125
- rearing 61-73
- rotifer cultures as food for 70
- size grading 71-72
- supplemental feeding 71-73
- in tanks, starter feeds 100-105
- transport in Europe and N. America 78
- use of plastic tanks 100
- Fry rearing, equipment needed for 135
- research problems on larval rearing 142
- stage, defined ii
- transport vehicle, figured 78
- Fumadol, used to control insect predators in ponds 68
- Fungal diseases 119-20
 - Branchiomyces*, a serious pathogen 119
 - identification and treatment, summarized 128
 - Saprolegnia* 119
- Fungal infections, of eggs 126
- Funnel shaped devices for hatching 31
- merits and demerits 35
- Furacin, use as a prophylactic 117

- Galician mirror carp, height/length ratio preference 88
- use of in Germany and Poland 88
- Gas bubble disease 127
- cause 127
- ways of preventing 127
- Genetic improvement, accidental, of cultured and ornamental fish 21
- hybridization 83
- Genetics, Chinese carp 90
- common carp 86-89
- cultured carp 81-90
- deterioration during farming practices 81-82
- existence of common carp resources 89
- Indian major carp 90
- reduction of scope of improvement 89
- Genetics research problems, selection and hybridization 139-40
- German mirror carp, outperforming Japanese strain 89
- Gill flukes, serious helminth parasites 123
- treatment for infestations 123
- Gill rakers, in silver carp 5
- Gill rot, a fungal disease 119
- Glass hatching jars 31
- figured 32

- Gold brown Katjera Domas, subvariety of common carp 8
- Gomphidae*, predators on spawn 67
- Gonadotrophins, effects of bioassayed extracts 54
- Gonads, irradiation of products 86
- stages of maturation, listed 44
- Gram negative bacteria, broad spectrum treatment recommended 120
- Grass carps, age at first maturity 3
- as biological controllers of weed in rearing ponds 71
- change of diet during growth 98
- control of, in rearing ponds 71
- conversion ratios 3
- diet of fry 2
- dietary care of broodfish 41
- dilution of drugs used for transport 79
- distribution 1-2
- fecundity 3-4
- figured 2
- food 2, 40
- general description 1-3
- growth 2-3
- growth of postlarvae fed of various diets, figured 108
- induced breeding techniques 51
- limited information on crosses with other carps 90
- preferred weeds 2
- production of monosex or sterile progeny during selective breeding 86
- ratio of weights of donor and recipient fish equated in Hong Kong and Thailand 54
- in River Amur 1
- size 4
- spawning 3
- spread across warm temperate and tropical zones 82
- stunting of, in China 73
- supplementary foods 2
- teeth 2
- use of HCG in induced breeding in China 50
- weight of hatchling and ova 3
- weights of large fish 3
- in Yangtze and West River 3
- Grasses, to fertilize ponds 67
- Grazing as a means of weed control in rearing ponds 71
- Green manuring, in preparation of ponds 62
- Groundnut, in artificial feed for fingerlings 71
- Groundnut cake, in feeds for rohu monoculture 70
- Growth, as a basic requirement for a selective breeding program 85
- Growth, change of diet in grass carp 98
- in grass carp 2-3
- of grass carp in culture conditions 3
- optimum temperature ranges for carp 93
- poor, factors, in nursery and rearing ponds 61-62
- of silver carp 5
- Growth rate, of bighead carp 7
- of catla 11
- of common carp 9

- depression as a result of sib-mating 89
- heterosis in crossbred carp 89
- of mrigal 17
- of rohu 14
- Gynogenesis, cold shocking ova 86
 - mass production of ova in Hungary 89
 - selective breeding programs 85-86
- Gyrinidae*, predators on spawn 67
- Gyrodactylus, examination and treatment, summarized 128
 - genera of gill flukes 123
- Hanks saline and virus tests 132
- Hapas*, breeding *hapa*, figured 27
 - for breeding in India 57
 - cloth, for common carp hatchlings 59
 - floating 58
 - hatching 57
 - construction of 58
 - control of bacterial and fungal infections 58
 - control of temperature, water and oxygen 58
 - figured 27
 - to protect against predation 58
 - merits and demerits 35
 - used as a container for conditioning 74
 - used in breeding tank 28
- Harvesting, of nursery and rearing ponds 73
- Hatchery, airt-tanks 27-28
 - applicators needed in 137
 - assumptions to derive pond areas and numbers, tabulated 22
 - broodfish requirements assumed 24
 - chemicals needed 137
 - cloth enclosures or *hapas* 27
 - components described 26-37
 - components that are essential 22
 - construction planning 21
 - control of, for common carp 58
 - contour survey of site essential 21
 - defined i
 - Dr. Dwivedi's portable hatchery 33-34
 - fecundity assumed 24
 - the hatchery proper 27-28
 - implements needed for 133-37
 - list of personnel needs for operation and maintenance 143
 - list of tasks for operation and maintenance 143
 - location of ponds 26-27
 - maintenance tasks by scientific and technical personnel 145-50
 - miscellaneous laboratory apparatus needed 136-37
 - oxygen requirement in water 21
 - personnel requirements 138-44
 - pituitary hormone requirements assumed 24
 - pond requirements, summarized 25
 - production of compost 65
 - at Raipur, Noakhali, Bangladesh 27
 - ratios of carp species 23
 - rearing and nursery ponds required 24
 - requirements of ponds 20
 - research problems 138-44
 - satisfactory site characteristics, tabulated 22
 - silt causes problems 21
 - site requirements 20
 - soil quality 20-21
 - soil quality of ponds 20
 - sources of water 21
 - specialized scientific equipment needed 133-37
 - structural features of ponds 25-26
 - types of apparatus used for common carp 58-59
 - types of broodfish ponds in 38
 - water table requirements 21
 - water quality 21
- Hatchery engineering, research problems, listed 140
- Hatchery maintenance, tasks listed, for Chinese and Indian major carp 149
- Hatchery management, research problems, listed 142
- Hatchery operators, advice needed on planning new introductions 89
 - summary of recommendations 90
- Hatchery procedures, set out clearly 36-37
- Hatchery proper, operational procedures, summarized 36-37
- Hatching, of common carp 58-60
 - use of *hapas* 57
- Hatching devices, funnel-shaped 31
 - funnel-shaped devices, figured 32
- Hatching jars 30-31
 - clear glass and plastic 31
 - figured 31-32
 - jars used 30
 - merits and demerits of water supply 35
 - volume 31
 - water supply arrangements 31
- Hatching methods, merits and demerits, tabulated 35-36
- Hatchlings, behavior of in common carp 59
 - care of common carp 58-60
 - cleanliness of tanks 99
 - of common carp 59
 - feed for catla, rohu, mrigal and silver 70
 - feeding of, in common carp 59
 - figured 59
 - first artificial food for common carp 59-60
 - use of plastic tanks 100
 - stage, defined ii
 - starter feeds in tanks 100-105
 - survival and weight of common carp, tabulated 102
- HCG, used for breeding bighead, silver and grass carps in China 50
 - use of in induced spawning 50
 - used in Malaysia for induced breeding in silver and bighead carps 50
- Health certification 130-32

- diagnostic procedures 131-32
 needs, discussed 130
 test requirements, tabulated 131
 Heat treatment, of feedstuffs for processing 114
 Helminths, and diseases 123-25
 Hemorrhagic enteritis, and cestode infestations 124
 Hemorrhagic septicaemias 120
 caused by *Aeromonas punctata* 120
 caused by *Pseudomonas fluorescens* 121
 symptoms 121
 treatment very difficult 121
Henneguya, examination and treatment, summarized 128
 and myxoboliasis 123
 Hertex W.P., control of predatory insects in ponds 67
 Heteroplastic, defined 46
 Heterosis, *see* hybrid vigor
 Holding pen(s), cleaning, figured 72
 cleaning out 71
 figured 72
 types of 71
 Homoplastic, defined 46
 Hong Kong carp, hybridizes with Dor 70 84
 Hormones, administration of steroids to effect sex
 inversion 86
 methyltestosterone, to effect sex inversion 86
 supply of pituitary-based gonadotropins 50
 synthetic LH-RHA, as ovulatory agents 54
 use of HCG in induced breeding 50
 HS, Hanks saline 132
 Human chorionic gonadotropic hormone. *See* HCG
 Hungarian carp, Dinnyés strain, figured 87
 hybridization of 88
 Hungarian common carp, hybrids of "land races" 84
 Hungarian stock, high performance strain 88
 Husbandry, nutrition of broodstock, tabulated 115-16
 Hyamine 3500, used as a disinfectant 117
 Hybrid crosses, between common carp strains 88
 Hybridization, between Indian major carps and common
 carps nonviable 90
 genetic improvement 83
 genetic research problems 139-40
 trials with catla, Indian major carps, kalbasu and
 rohu 90
 Hybrids, between races of Japanese, Chinese and Euro-
 pean carp 84
 of catla produced artificially 10
 of Hungarian common carp 84
 of mrigal 15-16
 of rohu 13
 Hybrid vigor, of "big belly" race of Chinese carp 84
 of European carp 84
 growth rate and disease resistance in crossbred carp 89
 seen in races of *Cyprinus carpio* 83-84
Hydrilla, used in breeding in India 57
 control of in rearing ponds 71
 food of grass carp 2
Hydrophilidae, predators on spawn 67
Hypophthalmichthys molitrix 1
 induced breeding techniques 51
 see also silver carps
 Hypophysation, only choice of Asian fish-farmers 50
 in controlled breeding of common carp 57
 development of, in supply of pituitary-based gonado-
 tropic hormones 50
 environmental conditions necessary 48
 operation of 44
 problems of 50
 see also pituitary gland
 Hypophyysis. *See* pituitary gland

Ich (white spot disease) 121
 and mortality of fry 126
Ichthyobodo, examination and treatment, summarized
 128
 and mortality of fry 126
 treatment with copper oxychloride 123
Ichthyobodo necatrix, and costiasis 122
 Ichthyophthiriasis (white spot disease) 121
 examination and treatment, summarized 128
Ichthyophthirius multifiliis, and white spot disease 121
 Identification of disease agents, summarized 128-29
 Ill health, factors of, in nursery and rearing ponds 61-62
 Incubating jars 27. *See also* hatching jars
 Incubation, equipment needed for 135
 India, stunting of Indian major carp 73
 Indian Council of Agricultural Research, assistance in
 establishing pituitary bank 50
 Indian designs of live-fish carriers 76-77
 Indian major carps, acclimation of 82
 anesthetizing drugs for transport 79
 artificial feeds for postlarvae 69
 breeding season in Asia 42
 export of seed 11
 genetics 90
 genetics information limited 90
 hatching jars in use, figured 32
 heavy losses from myxosporidian parasites 123
 hybridization with common carps 90
 hybridization trials 90
 induced spawning 43-60
 infectious dypsis 120
 maintenance tasks 145-49
 maintenance tasks for broodfish care 145-46
 maintenance tasks for care of spent fish 145-46
 maintenance tasks for induced breeding 146-47
 meristic counts of mrigal stocks 90
 microzooplankton diet 98
 packing density for fry and fingerlings 75-76
 protocol for pituitary induction of spawning 54
 receiving little attention from geneticists 81
 stunted in West Bengal 73
 see also catla, mrigal, rohu

- "Indirect selection", in aquaculture management practices 81
- Indjuk* fibers, figured 56
- Indjuk* plant, used for making kakabans 56
- Indonesia, quarantine procedures for fish 127-29
Regional Centre for Tropical Biology 127
- Indonesian orange-colored carp, subvarieties 8
- Induced breeding, anesthetics used during injections 47
bacterial infections during injection and stripping 47
and care of fish 47
environmental conditions necessary for hypophysiation 48
and fertilization 48
injection routes 47-49
intramuscular injections 47-48
intraperitoneal injections 47
preparation of injection material 46
release of injected fish into tanks 48
spawning 48
stripping 48-49
techniques used in Chinese carps, listed 51-53
use of HCG in bighead, silver and grass carps in China 50
use of pituitary glands from *Tachysurus* sp. and *Trichogaster pectoralis* 50
weight of pituitary gland required from donor fish 46
- Induced spawning, Chinese carps 43-60
Indian major carps 43-60
ovulating substances other than pituitary extract 50-55
use of HCG 50
- Infectious carp dropsy syndrome 120
- Infectious dropsy, a complex of diseases 118
examination and treatment, summarized 129
in Indian major carps 120
- Injection material, preparation of for induced breeding 46
- Injection routes, for induced breeding 47-49
- Injections, intramuscular, for induced breeding 47-48
figured 47
intraperitoneal, for induced breeding 47
- Inorganic fertilization of ponds 65-66
- Inorganic fertilizers, combinations available 66
mixture used in Alabama, U.S.A. 66
- Insect control, list of insect families harmful in nursery ponds 67
treatment in nursery ponds 67-68
- Insect families, predators on spawn 67
- Insecticides, used to control predators in ponds 67-68
- Insects, as food of common carp 8
- Iodophor disinfectants 117
- IPN virus testing 132
- Ipomoea*, control of, in rearing ponds 71
- Iron, requirements of rohu 97
- Irradiation, effects on fish gonads and pituitary gland 86
of spermatozoa for gynogenesis 86
techniques for selective breeding programs 86
- Isochrysis galbana*. See algae
- Israeli carp, carbohydrate diet of Dor 80 race 96
- Israeli carp stocks, and high performance strains 88
- Israeli mirror carp, Dor 70 race hybridizes with Taiwanese big belly 84
- Japanese common carp, hybrids, between Chinese and European races 84
- Japanese races of common carp 8
- Jar hatchery, figured 34
- Jars used for hatching 30
- Jussiaea*, control of, in rearing ponds 71
- Kakaban(s)* 55-56
of coconut fibres 57
construction of 56
figured 56
position of, during spawning 56
- Kalbasu, hybridization trials 90
- Kanamycin, and hemorrhagic septicaemia 121
- Kanamycin sulphate, effective against bacterial pathogens 120
- Khawia sinensis*, parasitic cestode 124
- Krill, as protein source for advanced common carp 109
- Labeo calbasu*. See kalbasu
- Labeo rohita* 1. See also rohu
- Laboratory, apparatus needed for hatchery 136-37
- Laboratory tests, for viruses 131-32
- Laboratory upkeep, tasks listed for Chinese and Indian major carp 149
- Larval rearing, fry rearing research problems 142
phase of 61
postlarval nursing research problems 141
research problems, listed 141-42
soil quality research problems 141
water quality research problems 141
- Larval rearing tanks 27-28
- Lausitzer carp, hybridization of 88
- Leather carp, inferiority of growth, performance and survival 89
variety of common carp 8
- Leeches, affect carps 126
- Lemna*, as feed for grass carp fingerlings 73
food of grass carp 2
see also duckweed
- Lemna minina*. See duckweed
- Lemon-colored Sinyonya, subvariety of common carp 8
- Lentils, in dried food for hatchlings 70
- Lernaea*, examination and treatment, summarized 128
parasitic copepod 125
- Lernaea cyprinaceae*, and mortality of fry 126
symptoms of infestation 125
treatment 125
- Lernaea piscinae*, and serious mortality of fry 126
- LH-RHA, synthetic, as ovulatory agents 54
- Life history stages, defined ii

- Ligula*, cestode genus 125
- Limes, forms used for liming 64
- Liming, forms of lime used 64
in ponds, advantages of 64
- Limnanthemum*, control of in rearing ponds 71
- Lindane, treatment for *Argulus* 125
- Linear programming, feed formulation 113-14
- Line carp, inferiority of growth performance and survival 89
- Liners, used in fish ponds 20
- Lipids, requirements of adult common carp 95
requirements of cultured carp 95
as sparing compounds 95
- Live-fish carriers, Indian designs 77-78
- Live-fish transport, open canvas bags 78
- Live food diet, microencapsulated eggs as a supplemental food 105
- Log weeders, removal of weeds in rearing ponds 71
- "Long bodied" carp in Yangtze R. 8
- Loss of condition, in sanguinicoliasis 124
- Luteinizing hormone-releasing hormone analogues.
See LH-RHA
- MacDonald jars, for hatching 30
- Macrovegetation, preferred by grass carp 2
- Mahua, dose of, for toxicity in ponds 63
as a toxicant in ponds 63
- Maintenance of hatchery, list of operational tasks 143
- Maintenance tasks, Chinese carp 145-49
Chinese carp broodfish and spent fish 145-46
common carp 150
Indian major carp 145-49
Indian major carp broodfish and spent fish 145-46
induced breeding in Chinese carp 146-47
induced breeding in Indian major carp 146-47
to be performed by scientific and technical personnel 145-50
- Majalayan strain, good candidate for genetic selection 88
summary information 89
variety of common carp 8
- Malachite green, to control fungal infections of eggs 126
details of treatment 119-20
use, summarized 128-29
used to control *Saprolegnia* infections 119
used in quarantine procedures 128
and white spot disease 122
- Mammen's live-fish carrier 77
- Management of nursery ponds, necessary measures 61
- Mansonil, an anthelmintic 124
- Manure(s) enriching nursery ponds 69
of broodfish ponds 40
organic, for broodfish ponds 40
- Manuring, doses of cattle manure, for ponds 65
doses of commercial compost, for ponds 65
doses of poultry droppings for ponds 65
- Masoten, used to kill copepod host in cestode infestations 125
treatment for gill flukes 123
- "Mass selection", unplanned programs of selection 81
- Maturity, age at in grass carp 3
in degree days 3
- Measurement, using *bati* cup 69
- Melanosis 126
- Meristic counts, of Indian major carps and mirgal stocks 90
- Metacercariae cysts, described 124
- Metal spikes, to remove weeds in rearing ponds 71
- Methyltestosterone, administration of in feeds to effect sex inversion 86
- Microcystis*, causing oxygen depletion in ponds 71
food of common carp 8
- Microencapsulated egg, as food for common carp 59-60
method of modification of, for supplemental food 105
procedure to make feed 104
as supplemental food to live food diet 105
- Microencapsulated egg diet, as starter feeds 104-5
- Microzooplankton, as diet for Chinese carp 98
as diet for Indian major carp 98
- "Militsch" carps, derivation of, as a result of hybridization 88
- Milletia pachycarpa*, as a fish toxicant in ponds 63-64
- Milling, of feedstuffs for processing 114
- Milt collection syringe in use, figured 49
- Minerals, requirements of adult common carp, and cultured carp 97-98
- Mirror carp, Aischgrunder race, suitability to ponds and climate 88
effect of different carbohydrate diets on fingerlings, figured 109
European 89
Galician, height/length ratio preference 88
Galician, use of in Germany and Poland 88
German, outperforming Japanese strains 89
Hungarian Dányés strain carp, figured 87
preference for scale-reduced varieties in Europe 86
preference for scaled-fish in Asia 86
superiority of growth performance and survival 89
variety of common carp 8
- Modular designs, in a hatchery 37
- Moina*, food of common carps 8, 101. *See also* cladocera
- Moina macrocopa*. *See* cladocera
- Moina micrura*. *See* cladocera
- Monogenetic trematodes and diseases 123
- Mortalities, among carp fry, organisms, listed 126
- Mortality, caused by unwanted fish 26
factors of, in nursery and rearing ponds 61-62
- Mirgal 15-19
age at first maturity 18
detritus eater 16, 40
dietary care of broodfish 41
distribution 15
essential vitamins in diet 96

- factors affecting growth 17
 - fecundity 18
 - feed for hatchlings 70
 - figured 16
 - first maturity 18
 - growth rates 17
 - hybrids 15-16
 - length at first maturity 18
 - meristic counts of moar and river stocks 90
 - oxygen consumption of fingerlings 75, 77
 - protocol for pituitary injections to induce spawning 54
 - spawning 18-19
 - transplantations 15
- MS 222 (tricaine methansulphonate), as an anesthetic 48
 - dose of, for injections 48
 - dose rates 79
 - used in controlled breeding of common carp 57
- Multitrait selection index 85
 - device for selective breeding program 85
- Murrels, *Channa* spp. as predators in ponds 61
- Mustard, in artificial feed for fingerlings 71
- Mustard oil, to control predatory insects in ponds 67
- Mustard oilcake, in feeds for rohu monoculture 70
- Mycobacteria, examination and treatment, summarized 129
- Myriophyllum*, used in Chinese system of breeding 57
 - control of, in rearing ponds 71
 - food of grass carp 2
- Myxobacteria, examination and treatment, summarized 129
- Myxobacterial diseases, identification and treatment, summarized 129
- Myxoboliasis, caused by myxosporidian parasites 123
 - no known treatment 123
 - symptoms 123
- Myxobolus*, examination and treatment, summarized 128
 - and mortality of fry 126
 - and myxoboliasis 123
- Myxophyceae, food of bighead carp 6
 - food for silver carp 5
- Myxosporidian parasites can cause heavy losses 123
- Myxosporidians, and heavy losses in fingerlings 126

- Najas*, used in breeding, in India 57
 - control of, in rearing ponds 71
 - food of grass carp 2
- Nasice, Yugoslavian race of common carp 8
- Nauplii, food of common carp 8
 - food of grass carp 2
- N-chloramines, used as disinfectants 117
- Neascus cuticola*, metacercariae infestations 124
- Nechandra*, control of in rearing ponds 71
- Neguvon, treatment for gill flukes 123
- Nelumbo*, control of in rearing ponds 70-71
- Nematodes, *Philometra lusiana* 124
- Neoplasia 126
- Nephritis, and sanguinocoliasis 124
- Nifurpirinol, treatment for vibrio infections 120
- Nitrate of soda, for use in production of compost 65
- Nitrofurans, use in treatment of diseases, summarized 129
- Nitrogen, as an inorganic fertilizer 66
- Nomenclature of carps 1
- Nononectids, in dried food for hatchlings 70
- Notonectidae*, predators on spawn 67
- Notopterus chilata*. See featherbacks
- N:P:K fertilizers, to create blooms to control weeds in rearing ponds 71
- Nursery pond management, measures necessary for 61
- Nursery ponds, enrichment by manure 69
 - eradication of predator insects 67-68
 - essential component of a hatchery 22
 - feeding of advanced carp fingerlings 106-7
 - feeding of advanced carp fry 106-7
 - fertilization of, for zooplankton production 64-65
 - gradual substitution of water, for postlarvae stocking 68-69
 - harvesting of 73
 - mortality caused by unwanted fish 26
 - need for filters 26
 - post-stocking operations, for Chinese and Indian major carps 148
 - pre-stocking operations, for Chinese and Indian major carps 147-49
 - rate of stocking for postlarvae 69
 - stocking of postlarvae 68-69
 - structural features 25
 - treatment for insect control 67-68
- Nursery and rearing ponds, factors causing mortality, ill health and poor growth 61-62
 - preparation. See pond preparation
- Nutrients, of whole chicken egg, tabulated 104
 - worksheet for diet formulation 113
- Nutrition, carp grower diet, composition 92
 - complete feed 91
 - of cultured carp 91-114
 - information on supplemental feed for broodstock, tabulated 115
 - plant protein digestibility as percentages by common carp and others 93
 - supplemental feed 91
 - table on broodstock and husbandry 115-16
- Nutritional, deficiency syndromes 126
- Nutritional overkill, in current feeding practice 98
- Nutritional requirements, adult common carp 93-98
 - of carp fingerlings, fry and postlarvae 98-107
 - of cultured carp 93-98
- Nymphaea*, control of, in rearing ponds 70-71
- Nystatin, used in virus tests 132

- O-group fish, stage, defined ii
- Oilcake, in artificial feeds for fingerlings 71
- Ompok bimaculatus*. See catfish 61
- Oodinium*, flagellate protozoan parasite of carps 122

- Open canvas bags, for live-fish transport, figured 78
- Open containers, galvanized iron steel boxes, figured 75
 latex foam galvanized iron boxes, figured 75
- Open system, for transplanting live fish 74
- Operational procedures of a hatchery proper 36-37
- Organic manure, as fertilizers for broodfish ponds 40
- Organic manuring 65
- Organic matter, food of common carp 8
- Organophosphates, used in mass culture of rotifers 59
 use of Sumithion 50 EC³, Baytex³, Dipterex⁵ in
 mass culture of rotifers 59
 use in treatment of diseases, summarized 128
- Oscillatoria*, food of common carp 8
- Ottelia*, control of, in rearing ponds 71
- Ova, details for silver carp 6
- Ovarian eggs or ova, stage, defined ii
- Ovulation, indications of, prior to stripping 49
- Ovulatory agents, synthetic LH-RHA 54
- Ovulatory substances, for induced spawning 50-55
- Oxygen, in hatchery water 21
- Oxygen consumption, mrigal fingerlings 75
 rohu fingerlings 75, 77
- Oxytetracycline, and columnaris disease 121
 and hemorrhagic septicemia 121
- Packing density, of catla adults and fingerlings during
 transport 77
 of fry and fingerlings during transport 75
- Paraformaldehyde, extremely toxic to fish 122
- Parasitic copepods 125-26
Argulus 125
Lernaea 125
- Parasitic helminths 123-25
 anthelmintics 124-25
 cestodes and acanthocephalans 124-25
 digenetic trematodes 123-24
 and diseases 123-25
 monogenetic trematodes 123
 most infestations do little damage to the fish 123
 nematodes 124
- Patro's live-fish carrier 77-78
- Peanut cake, in stunting diet 73
- Pellets, size for feedstuffs 114
- Penicillin, used in virus tests 132
- Periodicals, useful ones, listed 165-66
- Personnel needs listed, for operation and maintenance
 of hatchery 143-44
- Pesticides, used in mass culture of rotifers 59
- Petroyeasts, in fingerling feeds 109
- 2-Phenoxy-ethanol, dose recommended 79
- Philometra lusiana*, nematode parasite 124
- Phosphorus, availability in feed for common carp and
 rainbow trout 97
 as an inorganic fertilizer 66
- Phytoplankton, food for silver carp 5
 as a water conditioner 99
- Phytoplankton blooms, undesirable consequences in
 tanks 99
- Phytase, a digestive enzyme fish lack 97
- Pistia*, control in rearing ponds 70
 shade plant in rearing ponds 71
- Pituitary bank, established by F.A.O. 50
- Pituitary gland, acetone-dried extract from common
 carp 50
 ampoules containing extract, figured 50
 ampouling of crude extract 50
 choice of donor fish for collection 46
 collection during breeding season 146
 equipment needed for collection, preservation and
 storage 134
 hetero and homoplastic extracts, defined 46
 homogenized, figured 47
 homoplastic extracts injected into common carp 57
 irradiation effects not clear 86
 location 44
 potency maintained after acetone-drying 46
 powdered crude extract from common carp 50
 preservation in absolute alcohol or by acetone-
 drying 45-46
 removal 44-45
 weight required from donor fish 46
- Pituitary hormone, dose estimate 22, 24
- Pituitary injections, preparation of material 46
 procedures tabulated for Chinese carps 51-53
 procedures to induce spawning in Chinese and Indian
 major carps 54-55
- Plankton, abundance estimates in ponds 68
- Plastic bags, containers for transporting fry and finger-
 lings 75-77
 knotting and sealing, figured 75
 making of containers, figured 76
 simple method of protection, figured 77
 unsuitable to transport broodfish 76
- Plastic film liners, in hatchery ponds 20
- Plastic hatching jars 31, 33 (figured), 34
- Plenidae*, predators on spawn
- Ploughing, weed control in rearing ponds 71
- Polyculture, for bighead carp 82
 competition between bighead and catla 7
 for silver carp 82
- Polyethylene material, used in Dr. Dwivedi's portable
 hatchery 33
- Polyploidy, cold shock to produce 86
 and selective breeding programs 86
 triploid common carp 89
- Polyunsaturated fatty acids, an essential part of diet 95
- Ponds, advantages of liming 64
 assumptions made to design and run a hatchery,
 tabulated 22
 for broodfish 24-25
 and classification of soils in relation to N and P 66
 and Dubisch's breeding method 57
 fertilization 64-67

- Hofer's variation 57
 importance of chemistry 20
 location in a hatchery 26-27
 mahua as a toxicant for predatory and weed fishes 63
 mixed organic and inorganic fertilizers 66
 number of fingerlings needed to produce 100 t fish/year 23
 predator control 67-68
 preparation and application of toxicants 62-64
 preparation and green manuring 82
 preparation for rearing 70
 quicklime as a toxicant 63
 ratios of carp species to produce 100 t fish/year 23
 requirements in a hatchery 5, 20, 25
 seepage problems 20
 silt causes problems 21
 soil qualities required 20
 source of minerals and nutrients 21
 structural features required 25-26
 suitability of Aischgrunder mirror carp 88
 tea-seed cake as a toxicant 63
 and use of liners 20
see also broodfish, nursery, rearing and stock pond
- Pond soils, calcium requirements listed 63
 importance of 20-21
- Pop-eye, and gas bubble disease 127
- Portable hatchery, figured 32
- Posthodiplostomum cuticola*, metacercariae infestations 124
- Postlarvae of carp, artificial feeds 107-9
 basis of feeding in ponds
 best food for 64
 equipment for transport 135-36
 feeding habits 98-107
 feeds causing maximum growth 70
 food in common carp 8
 nutritional requirements 98-107
 rate of stocking in nursery pond 69
 rearing 61-73
 recommended maximum density in tanks 99
 stages, defined ii
 stocking in nursery ponds 68-69
 supplemental feeding in ponds 69
 survival rates 70
 volumes of different feeds given 69
- Postlarvae of common carp, characteristics of *Artemia*
 cysts used in rearing, tabulated 102
 food organisms, tabulated 99
- Postlarvae and fry, feeding schedule, tabulated 69
- Postlarval nursing, equipment needed 135
 research problems 141
- Post-stocking practices 69-70, 148
- Potamogeton*, food of grass carp 2
- Potassium, in fertilizers 66
- Potassium permanganate, in ante-tanks 36
 and columnaris disease 121
 a disinfectant 118
 and *Lernaea* infestations 125
 in quarantine procedures 128
 in treatment of diseases, summarized 129
- Poultry droppings, for manuring ponds 65
- Powdered milk, used to remove adhesiveness of common carp eggs 58
- Prawns, in dried food for hatchlings 70
- Praziquantel, an anthelmintic 125
- Predator control, in ponds 61, 63, 67-68
- Predators on spawn 67
- Preservation of pituitary glands 45-46, 134
- Pre-stocking operations 62-68, 147-49
- Prevention of diseases 117-19
- Processing of feedstuffs 114
- Proflavine hemisulphate, treatment of external lesions 120
- Progesterone, an ovulatory agent 54
- Prophylaxis of diseases, ground rules 117-18
- Proteins, crude levels in feeds 111-12
 digestibility of plants by common carps and other animals 93
 essential amino acids for common carps, summarized 94
- Protozoa, ciliate infestations 121-23
 flagellate infestations 122
 food of grass carp 2
- Protozoan blood parasite, *Cryptobia cyprini* 126
- Protozoan diseases, costiasis 122
ich (white spot) 121
 identification and treatment, summarized 128
 trichodinosis 122-23
- Protozoan infection, 121-23
 white spot disease 121
- Pseudomonas*, examination and treatment, summarized 129
 and hemorrhagic septicaemia 121
 and ulcerative skin conditions 120
- PUFA. *See* polyunsaturated fatty acids
- Pulses, in dried food for hatchlings 70
- Punten carp, Indonesian variety of common carp 8, 89
 summary information 89
- Puntius javanicus*, a carp used for weed control 71
- QAC compounds, used as disinfectants 117
- Quarantine, activities, summarized 129
 and cestode infestations 124
 need for 127
- Quarantine measures 127-30
 current methods in Indonesia 127-29
 for new fish 129-30
 size of tanks 129
- Quaternary ammonium compounds, used as disinfectants 117
- Quicklime, as a toxicant in ponds 63
- Quinaldine, anesthetic, used during injections 47
 dose of, during injections 47
 to be handled with care 79

- RAC, Reference Artemia Cysts 103
- Races, produced as a result of domestication of common carp 86
- strains and varieties, discussed 86
- Rainbow trout, availability of phosphorus in feed, tabulated 97
- realized responses to selection 85
- Rakes, to remove weeds in rearing ponds 70
- Randa dumetorum*, as a fish toxicant in ponds 64
- Rantjapaku method of breeding common carp 56
- Raw materials, selection for feed formulation 110
- Realized heritability, determination of during breeding program: 84-85
- Rearing, fry 61-73
- of fry to fingerlings 71
- of fry, practice methods 71
- postlarvae 61-73
- preparation of ponds for 70
- pre-stocking practices 62-68
- Rearing ponds, control of weeds 70-71
- essential features of a hatchery 22
- management of 70
- mortality caused by unwanted fish 26
- preparation of, for Chinese and Indian major carp 148-49
- structural features 25
- weed control 70-71
- Rectangular cement tanks, merits and demerits for hatching 36
- Rectangular tanks, being replaced by circular tanks 28 <
- Reference Artemia Cysts (RAC) 103
- Research, requirements of technically qualified staff, on selected disciplines 144
- Research on fry rearing, larval rearing 142
- Research on postlarval nursing, larval rearing 141-42
- Research problems, in a hatchery 138-44
- Research problems listed, biology and genetics 139-40
- hatchery engineering 140
- hatchery management 142
- larval rearing 141-42
- Research on soil quality, larval rearing 141
- Research on water quality, larval rearing 141
- Rhabdovirus carpio*, causes spring viraemia 118
- Rice bran, in artificial feed for fingerlings 71
- in feeds for rohu monoculture 70
- in stunting diet 73
- Riverine stocks of fish, biology research problems 139
- Rivers. *See* named rivers in geographical index
- Roccal, used as a disinfectant 117
- Rohu, 13-15
- age at first maturity 14
- dietary care of broodfish 41
- dietary requirement of iron 97
- distribution 13
- exported to different countries 13
- fecundity 15
- feed for hatchlings 70
- figured 13
- food 13
- food of fingerlings 13
- genital aperture of mature female, figured 45
- growth rates 14
- hemorrhagic septicaemias 120
- hybridization trials 90
- hybrids 13
- monoculture of spawn, food 70
- oxygen consumption of fingerlings 75
- prefers to feed on plants 13
- protocol for pituitary injections to induce spawning 54
- size at first maturity 14
- spawning season 14-15
- transplantations 13
- ulcerative skin conditions 120
- Popsha, USSR race of common carp 8
- Rotifers, food of common carp 8
- food of grass carp 2
- food of silver carp 3
- immune to Sumithion 68
- installation of airlift system in a rotifer pond, figured 60
- intensive culture, for feed for fry 70
- mass culture in Indonesia 59
- organophosphates used in pesticides in culture 59
- as starter feeds 101
- Royale variety, of common carp 8
- RTG2 cells 132
- Rushes, control of, in rearing ponds 71
- Russian mirror carp 8
- Sagittaria*, control of, in rearing ponds 71
- Salmon, effect of bioassayed gonadotropin on carps in Malaysia 54
- Salmonids, costiasis outbreaks 122
- range of heritability for growth trait values 85
- Salvinia*, shade plant to control weeds in rearing ponds 71
- Sand and pebble filters, advisable in ponds 26
- reverse flow filter, figured 26
- Sandox. *See* MS222
- Sanguinicola*, blood fluke 123-24
- Sanguinicoliasis, no known treatment 124
- symptoms 124
- Saprolegnia*, a cause of fungal disease 119
- controlled by malachite green 119
- and diseases of eggs 126
- examination and treatment, summarized 129
- SBI, swim-bladder inflammation 118
- symptoms 119
- Scale carp, an Asian "wild" race, figured 87
- Chinese "big belly", figured 87
- Malayan strain broodfish, figured 87
- superior growth and survival 89
- variety of common carp 8

- Scale patterns, and races, strains and varieties of common carp 86
- Schistocephalus*, a cestode genus 125
- Scientific personnel, hatchery requirements 138-44
 maintenance tasks in a hatchery 145-50
 research requirements by disciplines 144
- Secchi disc, used to judge plankton production in broodfish ponds 40
- Sedges, control of, in rearing ponds 71
- Seepage, ways to reduce in ponds 20
- Selection, for fast growth unlikely to yield significant benefits 89
 realized response in rainbow trout 85
- Selection and hybridization, genetic research problems 139-40
- Selective breeding, nomenclature problems with common carp 87
- Selective breeding programs 84-96
 additive genetic variance 84
 basic requirements 85
 determination of realized heritability 84-85
 determination of variance of commercially desirable traits 84
 gynogenesis 85-86
 improvements of single desirable traits 84
 individual selection 85
 irradiation techniques 86
 multitrait selection index 85
 polyploidy 86
 sex inversion 86
- Semi-controlled breeding, common carp 55
 criteria for choice of fat-bellied variety of common carp 55
 European method 57
 Indonesian method for common carp 55-56
 Sundanese method 55
- Sex, external distinguishing features in carps 43-44
- Sex inversion, and production of males in Hungary 89
 selective breeding programs 86
- Sexual maturity, a basic requirement for selective breeding 85
see also Age at first maturity
- Shrimps, in dried food for hatchlings 70
- Sib-mating, and a depression of growth rate 89
- Sieves, figured 72
- Silkworm pupae, added to supplemental feeds 70
 in feeds for rohu monoculture 70
- Silt, a hatchery problem 21
- Silver carp, age at first maturity 4-5
 anesthetics for transport 79
 dietary care of broodfish 41
 distribution 3
 egg weight and size 5-6
 fecundity 5-6
 feed for hatchlings 70
 figured 4
 food 5
 food of fry 3-4
 general description 3-6
 gill rakers 5
 use of HCG to induce breeding 50
 hemorrhagic septicaemia 121
 limited information on crosses 90
 natural growth rate 5
 phytoplankton feeder 6, 40
 in polyculture systems 82
 pituitary dose to induce spawning 54
 size and age at first maturity 4
 spawning 5
 stunting in China 73
- Simazine, used to control algae and weeds in ponds 70-71
- Single cell proteins, in feeds for fingerlings 109
- Sintex, low density polyethylene material 33
- Sinyona, summary information 89
- Size-grading fry, figured 72
- Skin flukes 123
- Sodium chloride, and *Lernaea* infestations 125
- Sodium nitrate, in fertilizer mixture 66
- Soil classification based on available P and N 66
- Soil quality, needs of a hatchery pond 20
 and research problems on larval rearing 141
- Southeast Asia, introduction of common carp 82
- Soybean milk, used in stunting diet 73
- Sparing, defined 95
- Sparing compounds 95
 importance of lipids 95
 other compounds 95
- Spawn collectors. *See kakabans*
- Spawning, and induced breeding 48
 determining readiness for 43-44
- Spawning seasons in the wild, bighead carps 7
 catla 12
 common carp 9
 grass carp 3
 mrigal 19
 rohu 14
 silver carp 5
- Specialized scientific equipment need in a hatchery 133-37
- Spent fish care, maintenance tasks 145-46
- Spermatozoa, irradiation and gynogenesis 86
- Spirodela*, feed for grass carp fingerlings 73
 a preferred weed for grass carp 2
- Spring viraemia of common carp 118
 examination and treatment, summarized 129
 symptoms 119
see also SV or SVC
- Stages of gonad maturation 43-44
- Starter feeds, *Artemia* nauplii 101-3
 for carp fry and hatchlings 100-105
 microencapsulated egg diet 104-5
 recommended sizes and densities of live organisms, tabulated 101

- Steroid hormones, and sex inversion 86
- Stock, careful choice of, for aquaculture 83
 Hungarian, Israeli, and Yugoslavian high performance strains 88
 imports have advantages 83
- Stock improvement, choosing a founder stock 82
- Stocking densities, of fry 71
 in nursery ponds 69
 of postlarvae, fry, and fingerlings to give 100 t fish/year 24
- Stocking procedures, relevant factors 61-73
- Stock ponds, community 28
 functions of 38
 structural features 25-26
see also broodfish, nursery and rearing ponds
- Storage of pituitary glands 134
- Storage tanks 27. *See also* ante-tanks
- Strains, of common carp 8, 86-88
 Majalayan and genetic selection 88
- Strains, races and varieties, discussed 86
- Streptomycin, used in virus tests 132
- Stripping, of broodfish and equipment needed 134-35
 figured 49
 method 49
 number of persons required 49
 timing of, when ovulation is induced 51-55
- Stunting diet, for fry and fingerlings 73
- Subspecies of common carp 7
- Sundanese method of semi-controlled breeding 55
- Sulphonamides, treatment of diseases, summarized 129
 treatment of erythrodermatitis 120
- Sumithion 50 EC, selective action on rotifers and crustaceans 59
 toxicity to insect predators in ponds 68
- Superphosphate, in compost production 65
 in fertilizer mix 66
- Supplemental feeding, of postlarvae in ponds 69
- Supplemental feeds, broodstock information, tabulated 115
 composition at Raipur Hatchery, Bangladesh 91
 fishmeal added 70
 formulation 91
 silkworm larvae added 70
- Supplemental food, microencapsulated egg 105
- Supplementary feeding, of fry and fingerlings 71-73
- Supplementary feeds, necessary for broodstock 114
- Supplementary foods, for grass carp 2
- SV or SVC, spring viraemia of common carp 118-19, 129
- Sweden, Ewos C10 "Larvstart", a carp starter feed 101
- Swim-bladder inflammation, examination and treatment, summarized 129
 a viral disease 118
see also SBI
- Symptoms, *Argulus* infestations 125
 cestode infestations 124
 columnaris disease 121
 digenetic trematode infestations 123
 epidermal epithelioma 119
 erythrodermatitis 120, 131
 hemorrhagic septicaemias 120-21
Ich (white spot disease) 121
 infectious dropsy 119
Lernaea cyprinacea infestations 125
 myxoboliasis 123
 sanguinicoliasis 124
 spring viraemia 119
 swim-bladder inflammation 119
- Tachysurus* sp., use of pituitary gland in Thailand 50
- Taficide-80⁹, a weedicide in rearing ponds 70
- Taiwanese big belly carp, hybridizes with *Dor* 70 84
- Tamoxiphen, as ovulatory agents 54
- Tanks, circular 28-30
 different types in a modern hatchery 27
 dimensions for cylindrical tanks, figured 100
 fouling of by yeasts 108
 for hatchlings 100
 outflow filter for cylindrical tank, figured 100
 plastic, for hatchlings 100
 plastic, for fry 100
 recommended maximum density of postlarvae 99
 use of plastic tanks for rearing food organisms 100
- Tannin, to remove adhesiveness of common carp eggs 57-58
 toxicity to common carp eggs 58
- Tasks, listed for operation and maintenance of hatchery 143
- Tea-seed cake, as a toxicant in ponds 63
- Technical periodicals, useful ones, listed 165-66
- Technical requirements, of hatchery 138-44
- Teepol, to control predatory insects in ponds 67
- Teeth, in grass carp 2
- Temperature, and maturity in grass carp 3
 and maturity in silver carp 5
 optimum ranges for growth of carp 93
 for transporting fish in tropics 79
 of water for transporting fish 79
- Terramycin, used to treat erythrodermatitis 120
 used as a prophylactic 118
 used in quarantine procedures 128
- Terrestrial livestock, domestication of 81
- Testes, large sizes in common carp 9
- Thelohanellus*, a myxosporidian which kills carp fingerlings 126
- Tilapias, blue-green algal cell wall digestion 92-93
 sex inversion 86
- Tjimindi method, breeding in common carp 56
 semi-controlled breeding 55
- Toxicants, Derris powder application 62
 of plant origin 63-64
 in pond preparation 62-64
- Toxicosis 126
- Trace elements, requirements of adult common carp 97, 98
 requirements of cultured carp 97-98

- Transplantations, of mrigal 15
of rohu 13
- Transport, of broodfish, equipment for 80, 133-34
of fingerling, equipment for 135-36
of fry, equipment for 135-36
of live broodfish 74-79
of live fish seed 74-79
of postlarvae, equipment for 135-36
- Transport containers, galvanized sheet iron boxes, figured 75
cloth bag for transporting broodfish, figured 80
open canvas bag, figured 78
plastic bags, figured 76
- Transporting broodfish, plastic bags unsuitable 76
- Transport of fingerlings and broodfish, containers 75-78
Indian designs of carriers 76-77
- Transport of fish fry and fingerlings, containers for 75-76
- Transport of fry, in Europe and N. America 78
- Transport of live fish, use of anesthetic drugs 78-80
conditioning for 74-75
temperature of water 79
- Transport vehicle for fry, figured 78
- Trapa*, control of, in rearing ponds 71
- Treatment, *Argulus* infestations 125
care when dealing with young stages 126
cestode infestations 124-25
columnaris disease 121
costiasis 122
of diseases 117-18
erythrodermatitis 120
of fungal infections of eggs 126
of gill flukes 123
hemorrhagic septicaemia 121
Lernaea infestations 125
none for myxoboliasis 123
none for sanguinicoliasis 124
summarized for fish diseases 128-29
trichodinosis 122-23
white spot disease 122
- Trematodes, and diseases 123-24
see also monogenetic trematodes, digenetic trematodes
- Trichlorphon, treatment for gill flukes 123
- Trichodina*, examination and treatment summarized 128
and mortality of fry 126
and trichodinosis 123
- Trichodinosis 122-23
complete diagnosis may be difficult 122
treatment 122-23
- Trichogaster pectoralis*, use of pituitary gland, in Thailand 50
- Tubificid worms, hosts in cestode life cycles 124
- Tumors 126
- Typha*, control of, in rearing ponds 71
- Ulcerative skin conditions 120
- Uncontrolled breeding of common carp 55
- Urea/NaCl, to remove adhesiveness of common carp eggs 58
- Utricularia*, control of, in rearing ponds 71
- Vallisneria*, control of, in rearing ponds 71
food of grass carp 2
- Varieties, of common carp 86
scale patterns of common carp 86
- Varieties and strains, of common carp 8
- Varieties, races and strains, discussed 86
- Vegetable wastes, to fertilize ponds 67
- Vibrio* spp. and ulcerative skin conditions 120
- Viral diseases 118-19
infectious dropsy 118-19
epidermal epithelioma 119
no effective treatments 119
spring viraemia of common carp 118
tests for 131-32
- Vitamins, deficiency symptoms in carps 96
essential for diet of mrigal 96
requirements of adult common carp 96
requirements of cultured carp 96
summary of requirements, of common carp 94
- Wallago attu*. *See* catfish 61
- Walsura piscidia*, as a fish toxicant in ponds 64
- Ward tanks. *See also* breeding tanks 27
- Water, "cold" water used for flushing 25
- Water conditioner, phytoplankton 99
- Water fleas. *See also* cladocera 2, 5, 105-6
- Water hyacinth, as a compost 65
- Water quality, most important requirement of a hatchery 21
research problems on larval rearing 141
- Water table, requirements in a hatchery 21
- Weed control, of rearing ponds 70-71
- Weedicides, in rearing ponds 70-71
- Weights, of large grass carp 3
- Wells, source of water for a hatchery 21
- Wescodyne, an iodophor disinfectant 117
- Wheat bran, in feeds for rohu monoculture 70
- White spot disease 121-22
caused by *Ichthyophthirius multifiliis* 121
symptoms 121
treatment 122
- Wild strains of common carp, information 88-89
- Wolffia*, control of, in rearing ponds 71
as feed for grass carp fingerlings 73
food of grass carp 2
- Yamato, Japanese race of common carp 8
- Yamato strain, out-performed by German mirror carp 89

Yeast, analysis of artificial food 108
 fouling of tanks 108
Young stages, take care when treating diseases 126
Yugoslavian stock, high performance strain 88

Zestocarp, an anthelmintic 124
Zooplankton, fertilization of nursery ponds for production 64-65

 food for silver carp 3
Zoug jars, for hatching, figured 30
Zug-Weiss jars, for hatching 30