



## Effect of pH on the transport and adsorption of organic micropollutants in ion-exchange membranes in electro dialysis-based desalination



Malgorzata Roman<sup>a,b,\*</sup>, Leonardo Gutierrez<sup>b,c</sup>, Laurens H. Van Dijk<sup>a</sup>, Marjolein Vanoppen<sup>b</sup>, Jan W. Post<sup>a</sup>, Bas A. Wols<sup>a,d</sup>, Emile R. Cornelissen<sup>b,d</sup>, Arne R.D. Verliefde<sup>b</sup>

<sup>a</sup> Wetsus, the Netherlands

<sup>b</sup> Particle and Interfacial Technology Group, Ghent University, Belgium

<sup>c</sup> Facultad del Mar y Medio Ambiente, Universidad del Pacifico - Ecuador

<sup>d</sup> KWR Water, the Netherlands

### ARTICLE INFO

#### Keywords:

Organic micropollutants  
Electrodialysis  
Ion-exchange membranes  
Adsorption  
Transport

### ABSTRACT

In energy-efficient electro dialysis desalination processes, salt ions are transported from seawater (high salinity) to wastewater (low salinity) through ion-exchange membranes. Besides salt ions, also organic micropollutants can be transported from wastewater (high in organics) to seawater (low in organics). The transport mechanisms of organic micropollutants through ion-exchange membranes are complex phenomena, and pH has a tremendous impact on them. Since pH variations in electro dialysis operation are common, it is of crucial importance to investigate its influence on these mechanisms. Therefore, a large pool of nineteen organic micropollutants of various physicochemical characteristics was selected and added to artificial wastewater, at environmentally relevant concentrations. Approximately twenty of these physicochemical properties were statistically analyzed to elucidate the dominant mechanisms affecting adsorption and transport of organic micropollutants as a function of pH. Additionally, the influence of different current densities on the transport of organic micropollutants at different pH conditions was studied. This pH effect has now been investigated for the very first time, leading to essential conclusions on the practical applicability of electro dialysis for seawater desalination. The presented findings advance our understanding of the type of interactions between organic micropollutants and ion-exchange membranes.

### 1. Introduction

Organic micropollutants (OMP) comprise a broad spectrum of chemicals of anthropogenic origin, e.g., pharmaceuticals, pesticides, personal care products, or plasticizers. Due to structural diversity and a large variety of physicochemical properties of OMPs, an efficient wastewater treatment solution to remove all OMPs has not yet been developed. As treated wastewaters are mostly discarded into surface waters, OMPs are continuously being introduced to aquatic environments. As a result, OMPs have been frequently detected in surface waters above natural background levels ( $\text{ng L}^{-1}$  up to  $\mu\text{g L}^{-1}$ ) [1–9].

Due to the pressing global water scarcity issue, treated wastewater is increasingly becoming a valuable resource stream. Current water management strategies in many regions (e.g., Singapore, California, and Australia) have highlighted the importance of wastewater reuse [10–13]. Unfortunately, the direct production of drinking water from wastewater is currently beyond reach due to the presence of OMPs,

legal regulations, and social acceptance. In the past years, developments in ion-exchange membrane (IEM) technology have allowed electro dialysis (ED) to reach better performance and competitiveness towards other seawater desalination techniques [14]. However, in a stand-alone operation mode, ED remains energy- and cost-intensive [15]. Hybrid seawater desalination systems have gained increasing attention as cost-effective processes to produce drinking water from seawater. For this reason, the reuse of treated wastewater as a low-salinity stream in electro dialysis (ED)-based processes constitutes a promising approach for the pre-desalination of seawater and subsequent production of drinking water [14,15]. However, the potential transport of OMPs from wastewater to seawater channels through ion exchange membranes (IEM) is not yet fully understood and requires additional research efforts.

Previous investigations on IEMs-based separation processes mainly focused on parameters directly influencing process performance in terms of ion transfer (e.g., membrane properties such as electrical

\* Corresponding author at: Wetsus, the Netherlands.

E-mail address: [malgorzata.roman@wetsus.nl](mailto:malgorzata.roman@wetsus.nl) (M. Roman).

<https://doi.org/10.1016/j.seppur.2020.117487>

Received 10 May 2020; Received in revised form 29 June 2020; Accepted 28 July 2020

Available online 01 August 2020

1383-5866/© 2020 The Authors. Published by Elsevier B.V. This is an open access article under the CC BY license (<http://creativecommons.org/licenses/by/4.0/>).

resistance) and overall energy consumption; specifically, flowrates and conductivities of diluate and concentrate [16–18]. While pH has usually been monitored in those systems, its impact on the process itself or the transport of OMPs has never been analyzed as a critical variable. Large pH variations in electro dialysis operation are typical for this process, e.g., in the treatment of industrial streams, and in the field of nutrients (resource) recovery [19,20]. It was shown that pH variations have an impact on the partition of OMPs in IEMs [21]. The nano-scale interactions between OMPs and IEMs are fundamental in governing the behavior of OMPs in IEMs separation processes [22]. These interactions change according to pH variations; thus, impacting the transport and adsorption of OMPs in IEMs.

Despite its importance, the effect of pH on the transport of OMPs in ED-based desalination systems is lacking in the literature and must be addressed for the successful industrial implementation of this technology. The objective of this study is to investigate the effect of pH on the transport of OMPs in IEMs in ED. A large pool of nineteen organic micropollutants (including pharmaceuticals, pesticides, and herbicides) of various physicochemical characteristics were selected and dosed to artificial wastewater at environmentally relevant concentrations. Approximately twenty physicochemical properties of OMPs were statistically analyzed to elucidate the dominant mechanisms affecting their adsorption and transport as a function of pH. Additionally, the influence of different current densities on the transport of OMPs at different pH conditions was studied. The current manuscript is an original work, where the effect of pH variations in ED on the adsorption and transport of OMPs in IEMs is studied in detail, leading to essential conclusions on the practical applicability of electro dialysis for seawater desalination. Furthermore, the presented results will highly assist in improving next-generation IEMs targeting OMP removal (i.e., controlling transport).

## 2. Materials and methods

### 2.1. Organic micropollutants and chemical analysis

Nineteen OMPs were selected based on their varied physicochemical properties and reported presence in treated wastewater (Appendix A). A mixture of OMPs (analytical grade, Sigma-Aldrich, > 98%) was prepared as a 2 mg L<sup>-1</sup> stock solution per solute and stored at 4 °C. The stock solution was further diluted to obtain a final concentration of 100 µg L<sup>-1</sup> of each OMPs for experiments. A liquid chromatograph-mass spectrometer (Agilent 6420 LC-MS/MS) with a selective electro-spray triple quad LC-MS/MS multiple reaction monitoring (MRM) transitions was used to determine the concentrations of OMPs. A Phenomenex phenyl-hexyl column (150 mm × 3 mm, 3 µm pore size) equipped with a guard column was used for chromatographic analysis. The inorganic neutral mobile phase consisted of 2.5 L Milli-Q water, 5 mL Ammonia 5 M, 1 mL Formic acid 99%, and 0.1 mL oxalic acid 1 M. Acetonitrile was used as an organic mobile phase. Prior analysis, all samples (1 mL) were spiked with a matrix modifier (50 µL), and an internal standard (50 µL). Agilent Mass Hunter Quant software was used to integrate and quantitate the peaks in the data files.

### 2.2. Experimental setup

A cross-flow IEM system (REDstack BV, the Netherlands) with five cell pairs of alternating anion-exchange membranes (AEM) and cation-exchange membranes (CEM) was used in the experiments (Fig. 1). The inner stack membranes were AEMs and CEMs (type 10, Fujifilm, the Netherlands), with a total membrane area of 0.1 m<sup>2</sup>. The external CEMs were Neosepta CMX (Neosepta, Japan). Custom-made spacers of 270 µm thickness were selected (Deukum, Germany). The platinum-coated electrodes on each side of the stack were connected to a potentiostat (A85111, Ivium Technologies, the Netherlands). Three solutions were prepared for each experiment: (i) artificial seawater of 0.5 M sodium chloride, (ii) artificial wastewater of 0.017 M sodium chloride

containing 100 µg L<sup>-1</sup> of each OMP, and (iii) an electrode rinse solution (ERS) of 0.5 M sodium sulfate. The wastewater and seawater were recycled over 5 L amber glass bottles during each experiment. The water transport was measured by recording the mass of wastewater and seawater in time during each experiment (MS8001TS, Mettler Toledo, Germany). The conductivity and pH of wastewater and seawater were continuously monitored in the outlet of the stack. An automatic fraction collector (LGS B.V., Ubbena, the Netherlands) with three-way magnet valves (CS3-230AC) connected to digital timers (JP Fluid Control, the Netherlands) was used to collect samples at specified time intervals for LC-MS analysis.

### 2.3. Experimental procedure

Different experimental approaches were conducted to investigate the effect of pH on OMPs transport through IEMs. In the first experiments, wastewater and seawater were not pH-buffered. In the second series of experiments, the pH of wastewater and seawater increased with 0.01 M sodium bicarbonate (NaHCO<sub>3</sub>). ED experiments were conducted at current densities of 25, 50, and 100 Am<sup>-2</sup>, whereby conductivity, pH, water transport, and potential were continuously monitored. All streams (ERS, artificial wastewater, and seawater) were recirculated through the system under a constant flow rate of 170 mL min<sup>-1</sup> (flow velocity of 0.0105 m s<sup>-1</sup> and residence time of 9.529 s). The duration of each experiment was determined based on reaching a desalination level of approximately 90% in the artificial seawater.

Prior to experiments, the setup was equilibrated with the OMPs solution. First, wastewater and seawater channels were saturated by recirculating OMPs-containing wastewater in two steps, both lasting 48 h (i.e., after the saturation step, the solution was replaced with fresh OMPs-containing wastewater). Then, wastewater and seawater were recirculated through the stack for 96 h to equilibrate the channels with the solutions selected for the experiments. To determine the transport and adsorption, the mass balance over the system was calculated (Eq. 1–2).

$$\frac{n_{sw}(t)}{n_{ww}(t=0)} = \text{transport} \quad (1)$$

$$1 - \left( \frac{n_{ww}(t) + n_{sw}(t)}{n_{ww}(t=0)} \right) = \text{adsorption} \quad (2)$$

where  $n_{ww}(t=0)$  is the initial amount of solute [moles] in wastewater (i.e., total amount of OMPs brought into the system in the experimental phase);  $n_{ww}(t)$  and  $n_{sw}(t)$  are the amounts of OMPs in wastewater and seawater, respectively, at a defined time of the experiment.

### 2.4. Statistical analysis

A Pearson's correlation matrix was used to investigate the influence of each of the physicochemical characteristics of the OMPs on their adsorption and transport. Pearson's correlation coefficient is a measure of linear dependence between two variables, ranging between -1 and 1. Strong correlations range between -0.5 and -1, and between 0.5 and 1. The correlation coefficient of the sample was as shown in Eq. (3).

$$r = \frac{\sum_{i=1}^n (x_i - \bar{x})(y_i - \bar{y})}{\sqrt{\sum_{i=1}^n (x_i - \bar{x})^2} \sqrt{\sum_{i=1}^n (y_i - \bar{y})^2}} \quad (3)$$

where  $n$  is the size of the sample,  $x_i$  and  $y_i$  are variables (results and OMPs properties) and  $\bar{x}$  and  $\bar{y}$  are the means of the variables (results and OMPs properties). The correlations were further validated by comparing their p-values with the level of significance ( $\alpha = 0.05$ ) [23].

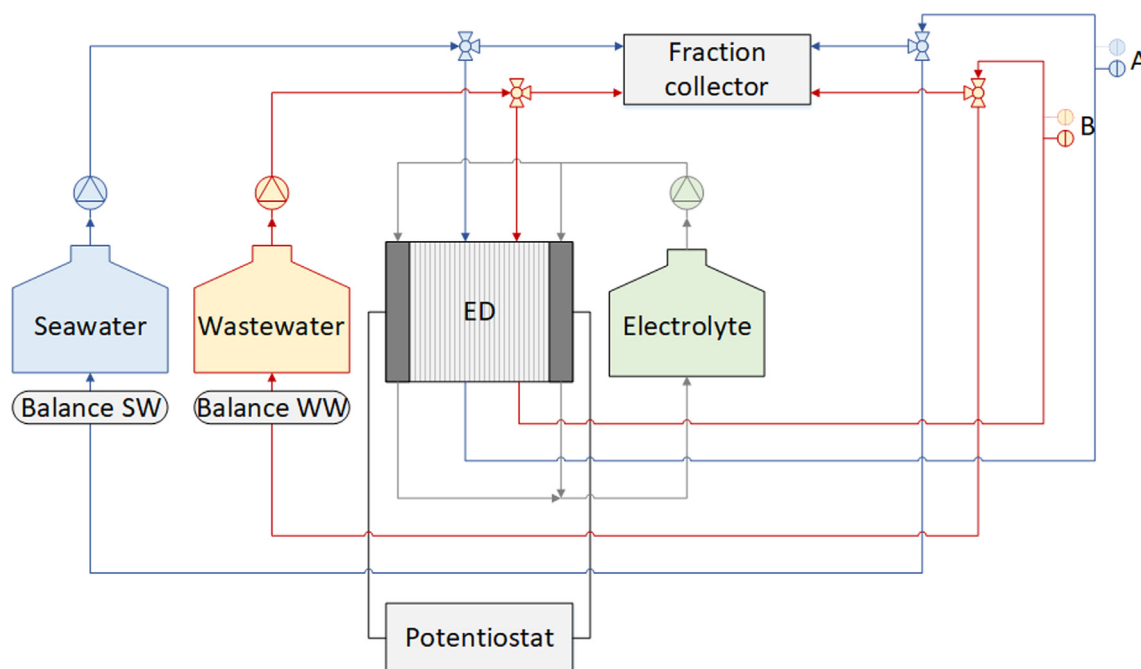

Fig. 1. Schematic representation of the experimental setup with a cross-flow membrane ED system. The platinum-coated electrodes on each side of the stack were connected to a potentiostat. Wastewater and seawater containers were placed on mass balances (Balance WW and Balance SW). Conductivity and pH were measured by the sensors located in the outlet of the cross-flow system (A and B).

### 3. Results and discussion

#### 3.1. Impact of current densities on the pH of wastewater and seawater solutions with and without NaHCO<sub>3</sub>

To study the effect of pH changes on OMPs transport through IEMs, first, we investigated pH changes in the IEM-system with and without the addition of NaHCO<sub>3</sub>. ED experiments were conducted at current

densities of 25, 50, and 100 Am<sup>-2</sup>, where the conductivity, pH, water transport, and potential were continuously monitored (Appendix B). Fig. 2 shows pH changes versus charge transfer in the artificial wastewater and seawater for all current densities in the presence and absence of NaHCO<sub>3</sub>.

In experiments without NaHCO<sub>3</sub>, the pH showed a steep decrease at the beginning of each experiment in both wastewater and seawater, for all current densities. The pH stabilized around a value of 3 for seawater

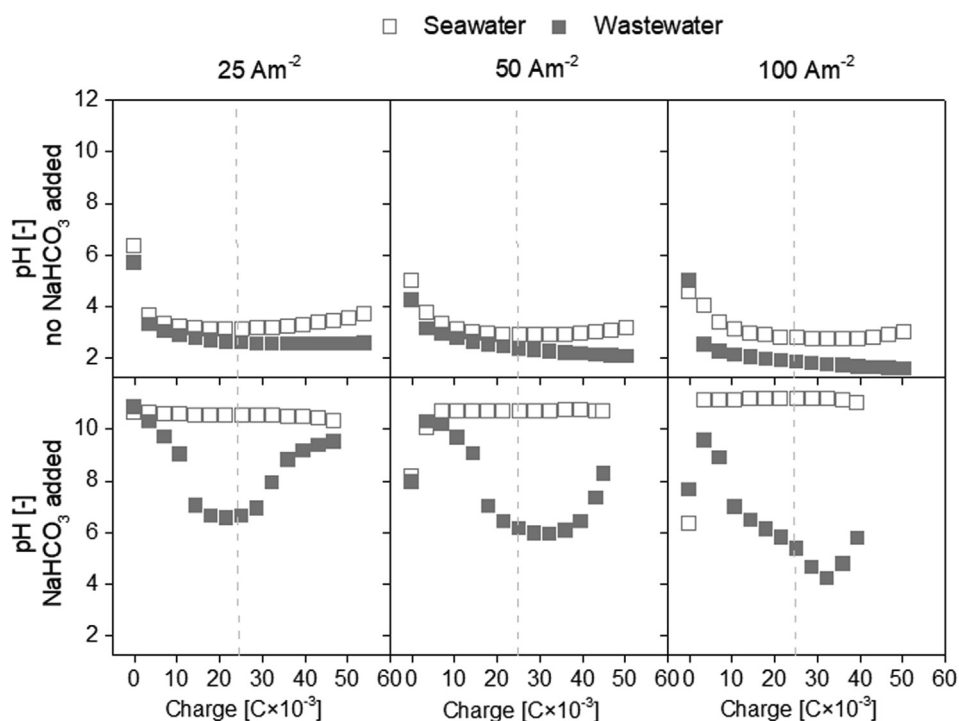
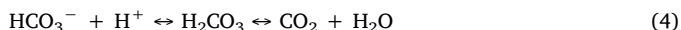

Fig. 2. pH records versus charge transfer in artificial wastewater and seawater for current densities of 25, 50, and 100 Am<sup>-2</sup> and in the presence and absence of NaHCO<sub>3</sub>. Dashed lines indicate the equalization of conductivities across the channels, all determined from the conductivity profiles (Appendix B).

and between 2.6 and 1.9 for wastewater, decreasing with increasing current density ( $R^2 = 0.997$ ). The acidification of the wastewater and seawater channels can be attributed to the production of protons during the electrolysis reaction at the anode. The protons were transported from the anode compartment through the outer CEM into the IEM stack. Hydroxide anions produced during reduction reactions at the cathode were blocked to some extent from entering the membrane stack by the outer CEMs.

Conversely, in experiments with  $\text{NaHCO}_3$ , the initial pH, approximately equal to  $\sim 8$  (which corresponds to the  $\text{NaHCO}_3$  concentration), of all solutions rapidly increased up to a value of approximately 10.8. This observation can be a result of forming  $\text{CO}_2$  under the process conditions (Eq. (4)) and removing it from the system through the recycle vessels (Section 2.2).



Next, the pH profile for seawater remained stable, while the pH of wastewater dropped and reached a minimum value of 6.54, 5.93, and 4.21 at 25, 50, and 100  $\text{Am}^{-2}$ , respectively. This decrease in pH is possibly caused by the high production of protons during the electrode reactions and their transport inside the membrane stack. As the compartment facing the anode was the wastewater and driving force to remove ions from the system was directed toward the wastewater compartment, more protons were transported to this compartment, resulting in a pH drop in wastewater. Furthermore, pH increased slowly, which can be related to developed buffer and removal of  $\text{CO}_2$  in the recycle vessels (Section 2.2).

One may wonder why in experiments without  $\text{NaHCO}_3$ , pH dropped in both wastewater and seawater, while in experiments with  $\text{NaHCO}_3$ , pH dropped only in wastewater. The calculated concentration of protons in unbuffered experiments is in the range between 1 mM (seawater) and 10 mM (wastewater), while in experiments with  $\text{NaHCO}_3$ , the concentration of protons is in the range between 1E-08 mM (seawater) and 6E-02 mM (wastewater). This indicates that the proton transfer from wastewater to seawater stream is smaller than from ERS to wastewater stream. Since the concentration of protons in wastewater stream (unbuffered experiments) was 10-fold higher compared to seawater stream, developed bicarbonate buffer (10 mM  $\text{NaHCO}_3$ ) maintained pH only in seawater stream.

### 3.2. Effect of pH on the ionization of OMPs

As presented in the previous section, experimental conditions strongly affected the pH of seawater and wastewater streams during performed experiments. Changes in pH have a significant effect on OMPs' behavior. This is because OMPs are present in aqueous solutions as a mixture of ionized and non-ionized species, and the equilibrium between them is pH dependent. Changes in ionization induce changes in the formal charge, hydrophobicity, and the water solubility of the OMPs. The dependence of the formal charge and hydrophobicity on pH, of all used OMPs, is presented in Fig. 3.

In the current study, we introduce the classification of OMPs, which is useful for the data interpretation in the following sections. The classification is based on the charge change of OMPs with reference to the initial pH conditions of performed experiments:

**Unbuffered experiments.** pH conditions in wastewater and seawater were similar (Fig. 2), that is why the properties of OMPs in both streams were consistent. For these experiments, four groups of OMPs were distinguished:

- “Positive A”: positively charged OMPs that maintained positive charge at low pH in comparison with the reference conditions. To this group belongs: lincomycin, metoprolol, atenolol, propranolol, pirimicarb, salbutamol, and terbutaline.

- “Positive B”: positively charged OMPs that changed their charge from neutral (in reference pH) to positive (as they are protonated at low

pH). To this group belongs: atrazine and simazine. Contrary to the Positive A group, atrazine and simazine were not entirely protonated at low pH. Thus, the hydrophobicity of atrazine and simazine was higher compared to the OMPs in the Positive A group.

- “Zero A”: non-charged OMPs that remained neutral at low pH in comparison with the reference conditions. To this group belongs: diuron, dimethoate, caffeine, and paracetamol. The Zero A group remained hydrophobic, showing a low water solubility in the whole experimental pH range.

- “Zero B”: non-charged OMPs that denoted as a negatively charged (in reference pH) changed their formal charge into neutral. To this group belongs: diclofenac, triclopyr, ketoprofen, fenoprofen, clofibrac acid, and ibuprofen. Hydrophobicity of the Zero B group increased with a decrease of pH.

**Buffered experiments.** In experiments where  $\text{NaHCO}_3$  was added, pH values of seawater and wastewater were different. Therefore, we distinguished OMPs groups for each wastewater (WW) and seawater (SW) stream:

**Buffered experiments - WW.** OMPs in the wastewater were characterized by a similar distribution of groups as in the reference conditions (i.e., positively-, negatively charged and non-charged).

- “Positive A”: OMPs characterized by a similar change in microspecies distribution, hydrophobicity, and water solubility, where the contribution of neutral species increased at higher pH values (i.e.,  $\text{pH} \approx 8$ ). Consequently, their hydrophobicity linearly increased between  $\text{pH} \approx 6$  to  $\text{pH} \approx 8$ . To this group belongs: lincomycin, metoprolol, atenolol, propranolol, and pirimicarb, salbutamol, and terbutaline. Salbutamol and terbutaline, due to their more complex chemical structures, were present in many different forms of microspecies in the wastewater.

- “Negative A”: In the experimental pH range, the hydrophobicity of these OMPs was in its low region, as the compounds were highly ionized. To this group belong: diclofenac, triclopyr, ketoprofen, fenoprofen, clofibrac acid, and ibuprofen.

- “Zero A”: OMPs were characterized by high stability toward pH changes in the experimental pH range. This was also reflected in the hydrophobicity profiles, where no changes were observed. To this group belong: diuron, dimethoate, atrazine, simazine, caffeine, and paracetamol. Atrazine and simazine contained partially protonated microspecies at  $\text{pH} < 6$  (i.e., wastewater at 100  $\text{Am}^{-2}$  current density), resulting in a drop of hydrophobicity. Paracetamol was mainly present in its neutral form in the wastewater, showing a stable hydrophobicity profile. Changes in ionization of paracetamol occurred at  $\text{pH} > 8$ , resulting in a hydrophobicity drop.

**Buffered experiments - SW.** in the seawater, two types of OMPs were distinguished: negatively charged and neutral OMPs.

- “Negative A”: Containing the same OMPs as Negative A in WW and following the same characteristics.

- “Negative B”: This group contains paracetamol, salbutamol, and terbutaline. Salbutamol and terbutaline were in the pH region located just above their isoelectric points. Thus, their hydrophobicity slightly dropped. Along with the dominant presence of deprotonated microspecies of paracetamol, its hydrophobicity dropped almost to its minimum level.

- “Zero A”: Beside paracetamol, this group contains the same OMPs as Negative A in WW and follows the same characteristics.

- “Zero B”: Group containing OMPs neutralized at high pH, i.e., lincomycin, metoprolol, atenolol, propranolol, and pirimicarb. At  $\text{pH} > 10$ , the microspecies distribution of these OMPs was completely dominated by non-ionized form, resulting in stable and high hydrophobicity.

### 3.3. Adsorption of OMPs in IEMs

#### 3.3.1. Adsorption of OMPs in IEMs under non-buffered conditions

Under non-buffered conditions, all OMPs in the wastewater



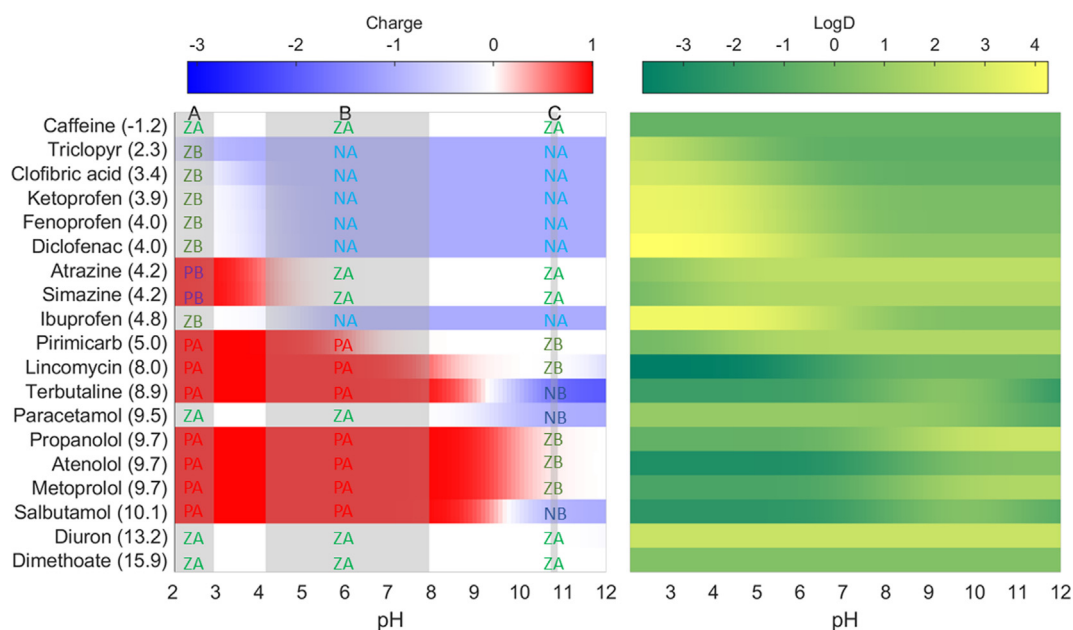

Fig. 3. Charge and hydrophobicity of organic micropollutants as a function of pH with their classification under measured pH regions in performed experiments: A - unbuffered experiment (experiment with NaHCO<sub>3</sub>); B - wastewater stream; C - seawater stream (experiment with NaHCO<sub>3</sub>). Charge, hydrophobicity, and pKa values were obtained from Chemicalize [24]

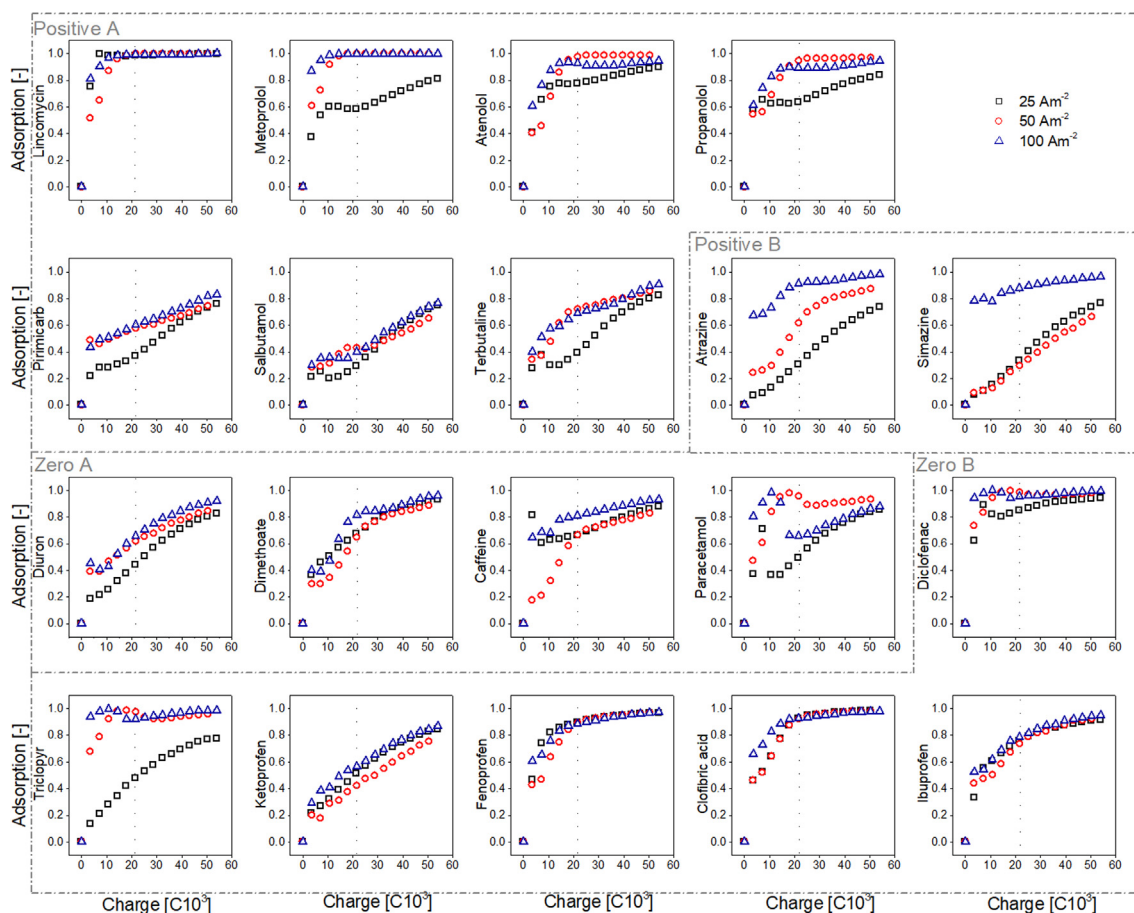

Fig. 4. Adsorption of OMPs in non-buffered experiments in all current densities. The OMPs were grouped accordingly to their charge, i.e., OMPs initially positively charged (Positive A group) and OMPs initially non-charged under neutral pH conditions, which protonated at low pH (group Positive B). Non-charged OMPs consisted of two types of compounds: OMPs initially neutral (group Zero A) and OMPs initially negative, which protonated at low pH (group Zero B). Dashed line indicates the equalization of the conductivity of wastewater and seawater.

adsorbed in IEMs independently of their charge; thus, no transport of OMPs to the seawater was observed. Fig. 4 shows the adsorption of OMPs for all current density experiments (25, 50, and 100 Am<sup>-2</sup>). The OMPs were grouped as described in Section 3.2. as positively charged (Positive A and Positive B) and neutral (Zero A and Zero B).

The final adsorption of all OMPs was similarly high (above 80%) for both protonated and deprotonated species. Consequently, low pH conditions have a positive influence on the adsorption by increasing the short-range OMPs–IEMs interactions, such as hydrophobic interactions, which became more prominent for deprotonated OMPs.

Except for lincomycin (i.e., adsorbed almost immediately in each experiment probably due to its large size), a clear trend among both Positive A and Positive B was observed. Specifically, higher current densities were more influential for the adsorption than the time frame of experiments. Briefly, the duration of experiments was 60, 28, and 14 h for 25, 50, and 100 Am<sup>-2</sup>, respectively. Thus, in the 100 Am<sup>-2</sup> experiment, the adsorption occurred not only to a higher degree but also in a shorter time and along with the highest counter transport of inorganic ions through IEMs. Currently, the literature does not contain detailed information regarding the adsorption mechanism of charged OMPs at low pH and under applied current density conditions. However, charge interactions have been reported to govern the adsorption of charged OMPs, especially evident for positively charged OMPs [22]. These charge interactions (i.e., related to the interaction between complementary charges) would occur between OMPs and functional groups of IEMs. Brusatori et al., 2003 investigated the adsorption of protein molecules under an applied electrical field. The transport-limited adsorption was not dependent on the applied voltage. However, in the moderate or high surface density regions, the adsorption considerably increased at higher voltages. Briefly, the adsorption occurred at regions of complementary charge, leading to more oriented and efficiently packed/adsorbed molecules for higher voltages and multilayer formation [25]. This could also explain the adsorption of charged OMPs in ED under low pH conditions. Increase interaction between membrane and OMPs would lead to a higher surface density of OMPs. The overall effect of the applied current density was not clearly observed in the adsorption of non-charged OMPs (Zero A and Zero B) (Fig. 4), except for triclopyr, which was not fully neutralized (Fig. 3).

### 3.3.2. Adsorption of OMPs in IEMs in buffered solutions

Fig. 5 shows the adsorption of OMPs in buffered conditions and in all current densities (25, 50, and 100 Am<sup>-2</sup>). For the analysis simplification, the wastewater conditions were assumed as more relevant for the adsorption, resulting in three groups of OMPs: Positive A(WW), Negative A(WW), and Zero A(WW). Under buffered conditions, the total adsorption of OMPs in IEMs was lower, and a difference between the adsorption of differently charged OMPs was observed. Briefly, Positive A(WW) group was characterized by the highest adsorption (above 40%) compared to Negative A(WW) and Zero A(WW) groups (maximum 40%).

Generally, the adsorption occurred gradually for all positively charged OMPs, except for terbutaline, which showed a steep adsorption profile at 25 Am<sup>-2</sup> current conditions. Also, almost no adsorption of terbutaline was observed at 100 Am<sup>-2</sup>, possibly due to the pH gradient across the IEMs and resulting in a high charge gradient of terbutaline (i.e., especially evident for 100 Am<sup>-2</sup>) (Fig. 3). Remarkably, the pH inside and at the surface of IEMs is not currently known. Thus, it is not entirely clear how this affects the ionization of OMPs, especially those which are characterized by many different microspecies forms, such as terbutaline. Possibly, terbutaline was neutralized at the membrane surface (or inside the membrane phase), which deprived charge interactions. Moreover, terbutaline was also characterized by the highest hydrophobicity drop in seawater, indicating that without an excess of protons, the adsorption does not occur at the surface of the membranes but also inside them.

Despite different properties, such as charge and hydrophobicity,

Negative A(WW) and Zero A(WW) adsorbed similarly. Compounds such as diclofenac, triclopyr, ketoprofen, fenoprofen, clofibric acid, ibuprofen, and diuron were clearly characterized by plateau regions occurring in the final hours of all experiments, confirming that membranes become saturated with those OMPs.

Fig. 5 shows that the adsorption of positively charged OMPs decreased at higher applied current density. Thus, low applied current conditions were more favorable for the adsorption, indicating that the mechanism of adsorption under neutral pH is different from that at low pH. Under non-buffered conditions, the increase in the adsorption along with current density was attributed to enhanced OMPs–IEMs interactions; thus, leading to a multilayer adsorption process. Under buffered conditions, the process was less dynamic and depended on the contact time between OMPs and IEMs. Also, the total amount of adsorbed OMPs was lower than in non-buffered conditions, indicating monolayer adsorption at more neutral pH conditions.

### 3.4. Transport of OMPs in IEMs

The transport of OMPs in IEMs was only observed under buffered conditions. Fig. 6 shows the transport profiles of OMPs in all applied current densities (25, 50, and 100 Am<sup>-2</sup>). For the analysis simplification, the seawater conditions were assumed as more relevant for the transport, resulting in four groups of OMPs: negatively charged (Negative A(SW) and Negative B(SW)), and non-charged OMPs (Zero A(SW) and Zero B(SW)).

Negatively charged OMPs were characterized by the highest transport (up to 20%), already detected in the first hours of experiments, whereas all other OMPs were recorded in the seawater after a few hours of experimentation. This intensive transport was evident for the Negative A(SW) group, following a non-linear transport profile. Negatively-charged OMPs have been reported as transported by Donnan dialysis under open-circuit conditions [22]. Donnan dialysis can also play a role in performed experiments, where three different current densities were applied. Thus, by Donnan dialysis effect, OMPs moved in a counter-direction toward the applied current and flux of salts. The driving force of the Donnan dialysis is the difference between the (electro)chemical potentials of similarly charged (positive vs. negative) species across the membrane. As OMPs are weak electrolytes and are present in a lower concentration than inorganic ions, the potential difference of chloride was considerably larger than the potential difference of negatively charged OMPs ( $\Delta E_{Cl^-}^0 \gg \Delta E_{OMP^-}^0$ ). This difference is large enough to induce the preferential transport of OMPs against the chloride concentration gradient, even under the applied current condition; thus, explaining the highest transport at the lowest current density. Interestingly, after the equilibration of the conductivity across the compartments (i.e., hence, the equalization of the electrochemical potentials across the membranes), and further increasing the potential of sodium and chloride ions in the wastewater, the reversal of the transport curve of diclofenac was observed. Specifically, the transport reversed along with the Donnan potential, constituting an important observation for understanding the mechanisms governing the transport of negatively charged OMPs. This result evidences that Donnan dialysis has a stronger impact on the transport of negatively charged OMPs than diffusion. For instance, paracetamol was initially a non-charged compound under neutral pH conditions, which gained a strong negative charge during the experiment; as a result, it also followed the Donnan dialysis transport at 25 Am<sup>-2</sup> experiment. However, this tendency was not observed in the profiles of salbutamol and terbutaline. Consequently, the charge in wastewater has an impact on the transport properties of OMPs, especially in the case of positively charged OMPs, which are characterized by a higher affinity toward IEMs than negatively and non-charged OMPs. For instance, terbutaline showed high adsorption strongly dependent on the applied current.

Non-charged OMPs were characterized by a linear transport, detected in the seawater after several hours of retardation. The transport

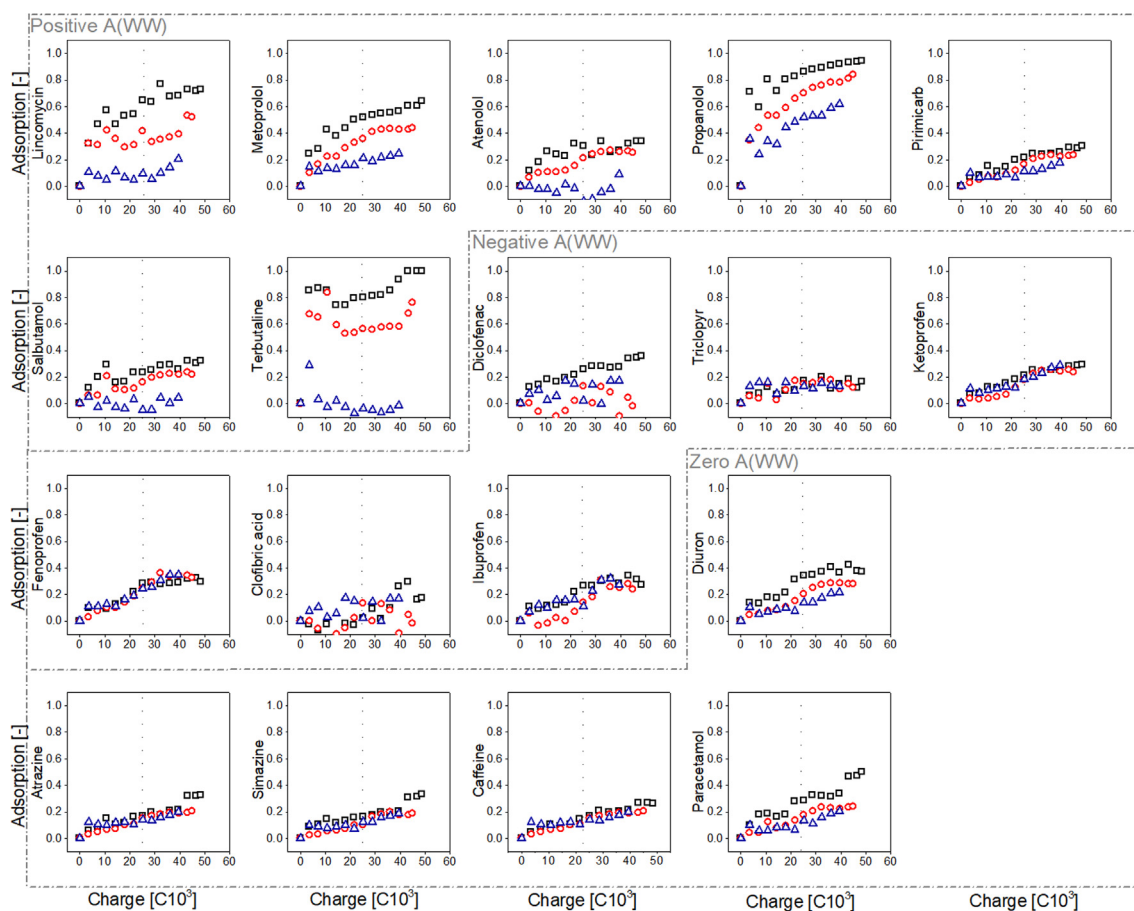

**Fig. 5.** Adsorption of OMPs in experiments under buffered conditions in all current densities. In the wastewater, where pH was at approximately neutral values, OMPs maintained their original charge. Three charge groups were identified: Positive A(WW), Negative A(WW), and Zero A(WW). Dashed line indicates the equalization of the conductivity of wastewater and seawater.

of initially neutral OMPs at neutral pH conditions (Zero A(SW)) was higher (up to 10%) than the transport of neutralized OMPs (below 5%).

### 3.5. Comparison between the mechanisms of interaction between OMPs and IEMs under different pH conditions

For a fundamental understanding of the mechanisms of interactions between OMPs and IEMs under low pH conditions, Pearson's correlation analysis was performed. Pearson's correlation coefficients ( $r$ ) were calculated for  $n-2$  degrees of freedom, at the point when the conductivity across the compartments were equal (i.e., specifically for pH 3 under non-buffered conditions, pH between 6 and 8 for wastewater), and pH 10 for seawater under buffered conditions. To calculate the correlation coefficients, OMPs were divided into charge defined groups (as described in section 3.2.). Only strong correlations ( $r \geq 0.5$  or  $r \leq -0.5$ ) were considered. Also, to validate the reported correlations, p-values were calculated and compared with the statistical level of significance ( $\alpha = 0.05$ ).

#### 3.5.1. Adsorption of OMPs in IEMs

Fig. 7 shows the correlation analysis of the adsorption of OMPs in IEMs in buffered and non-buffered experiments. Significant differences were recorded between the results corresponding to different pH (see Fig. 7).

At low pH conditions, the adsorption of positively charged OMPs was still preliminary based on electrostatic interactions with the opposite charges of the adsorbent [26]. Similar behavior was observed for all positively charged OMPs (both groups: Positive A and Positive B). Moreover, the effect of Taube's rule (i.e., a larger molecular size relates

to higher adsorption) was observed for positively charged OMPs. Large OMPs, such as lincomycin, metoprolol, propranolol, and atenolol, were almost immediately and fully adsorbed. The importance of the molecular size for adsorption was confirmed by Pearson's correlation, where the adsorption was positively correlated with the physicochemical properties of OMPs, which refer to the molecular size (e.g., Van der Waals surface and volume) for all three current densities. Since larger molecules are unlikely to penetrate the IEM polymer structure, this result might indicate that under applied current conditions and at a low pH, the adsorption of positively charged OMPs mainly occurred at the surface of the membranes. Also, this result contradicts the previous findings regarding the adsorption under zero current conditions and neutral pH [22]; thus, confirming the surface nature of the adsorption at low pH and under applied current conditions.

Only two physicochemical parameters of non-charged OMPs at low pH conditions were characterized by a significant correlation with adsorption: rotatable bond count and LogD. Considering the pH effect on the adsorption of the selected group of OMPs, where hydrophobic interactions play a key role in the process, hydrophobicity itself (i.e., which considers both ionized and unionized species) is pH-dependent [27]. Generally, the adsorption of non-charged OMPs occurred in the pH region of their high hydrophobicity (i.e., the experimental pH was below their pKa). These results are consistent with those of [28], reporting the importance of hydrophobic interactions for the adsorption at low pH.

Hydrophobic and  $\pi$ - $\pi$  interactions have been previously reported as a short-range interactions responsible for the adsorption of positively-charged OMPs at neutral pH and zero current conditions [22]. The contribution of  $\pi$ - $\pi$  interactions is questionable for positively charged

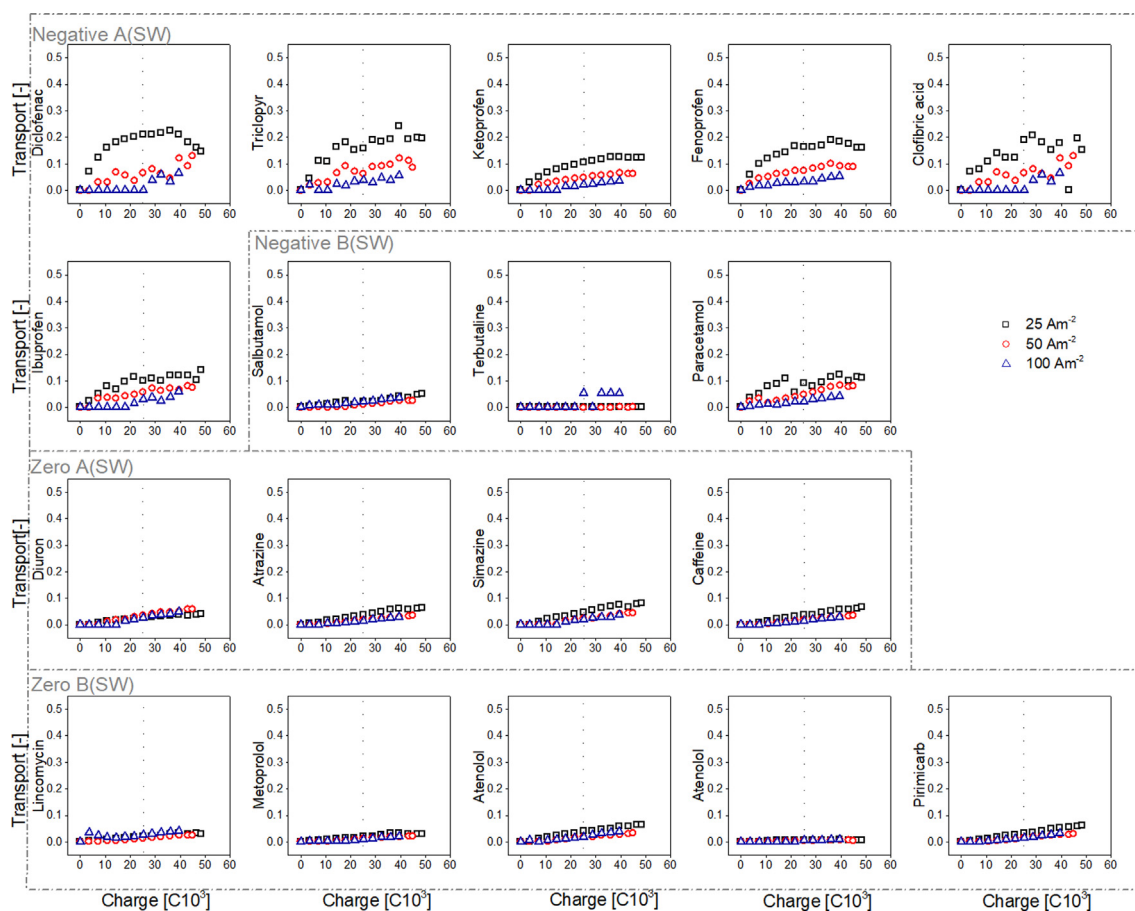

**Fig. 6.** Transport of OMPs under buffered conditions in all current densities. In seawater the following groups were observed: negatively charged OMPs (Negative A(SW) and Negative B(SW)) and non-charged OMPs (Zero A(SW) and Zero B(SW)). Dashed line indicates the equalization of the conductivity of wastewater and seawater.

OMP in the pH buffered conditions, as the correlation coefficient was not supported by the significance level (Fig. 7). However, the importance of hydrophobic interactions appears to be corroborated by the current results. The effect of hydrophobicity is clear from the strong correlation between the adsorbed amount of positively charged OMPs and their LogD. Interestingly, pirimicarb is the most hydrophobic of the positively charged OMPs (LogD = 1.76); however, it was mostly neutral at the pH values in the wastewater compartment. Pirimicarb showed low adsorption, confirming preferential adsorption of positively charged OMPs in IEMs. Furthermore, a correlation between molecular size and adsorption of positively charged OMPs was not observed, in contrast to the low pH conditions.

More statistically significant correlations were recorded for the group of negatively charged OMPs, in comparison to the positively charged OMPs, in pH buffered conditions. Also, a clear influence of  $\pi$ - $\pi$  interactions was observed by the strong positive correlation of their adsorption with ring count and aromatic ring count. The correlation analysis also showed that the adsorption of negatively charged OMPs follows Traube's rule.

The size dependence of the adsorption of non-charged OMPs was observed, however, opposed to Traube's rule. The smaller the molecule, the higher the adsorption. This result may indicate that adsorption occurred inside the membranes.

**3.5.1.1. Transport of OMPs in IEMs.** Fig. 8 shows the results of correlation analysis of transport of OMPs through IEMs in buffered experiments.

Three physicochemical properties were strongly correlated with the transport of negatively charged OMPs: polar surface area (negative

correlation), hydrogen count (negative correlation), and LogD in the wastewater compartment at pH = 6 (positive correlation). The negative correlation with the polar surface area was characterized by a similar strength as the correlation with hydrogen count, since the polar surface area is defined as the surface sum over all polar atoms or molecules (i.e., primarily oxygen and nitrogen), also including their attached hydrogen atoms, and hydrogen atom count. These two parameters can be a measure of hydrophilicity. Furthermore, a positive correlation was observed between transport and LogD; however, a correlation between the transport and LogD in seawater pH was not recorded. The three observed parameters would be responsible for governing the adsorption of OMPs in IEMs. Therefore, the adsorption would also govern the transport of negatively charged OMPs under applied current conditions.

The polarizability is the molecular ability to create an induced dipole moment under the applied current conditions. A strong negative correlation, additionally confirmed by the significance level, was recorded between the transport of non-charged OMPs and this property. The possibility to form dipoles was precisely related to the hydrophilicity of the molecule. More hydrophilic molecules are less prone to interact with IEMs, thus, having a direct consequence for the possibility of these compounds to penetrate IEMs.

#### 4. Conclusions

pH variations during ED affect transport and adsorption of OMPs present in low salinity stream, by affecting the ionization of OMPs.

Low system pH (unbuffered conditions) accelerates the adsorption of OMPs in IEMs, which efficiently prevents their transport toward



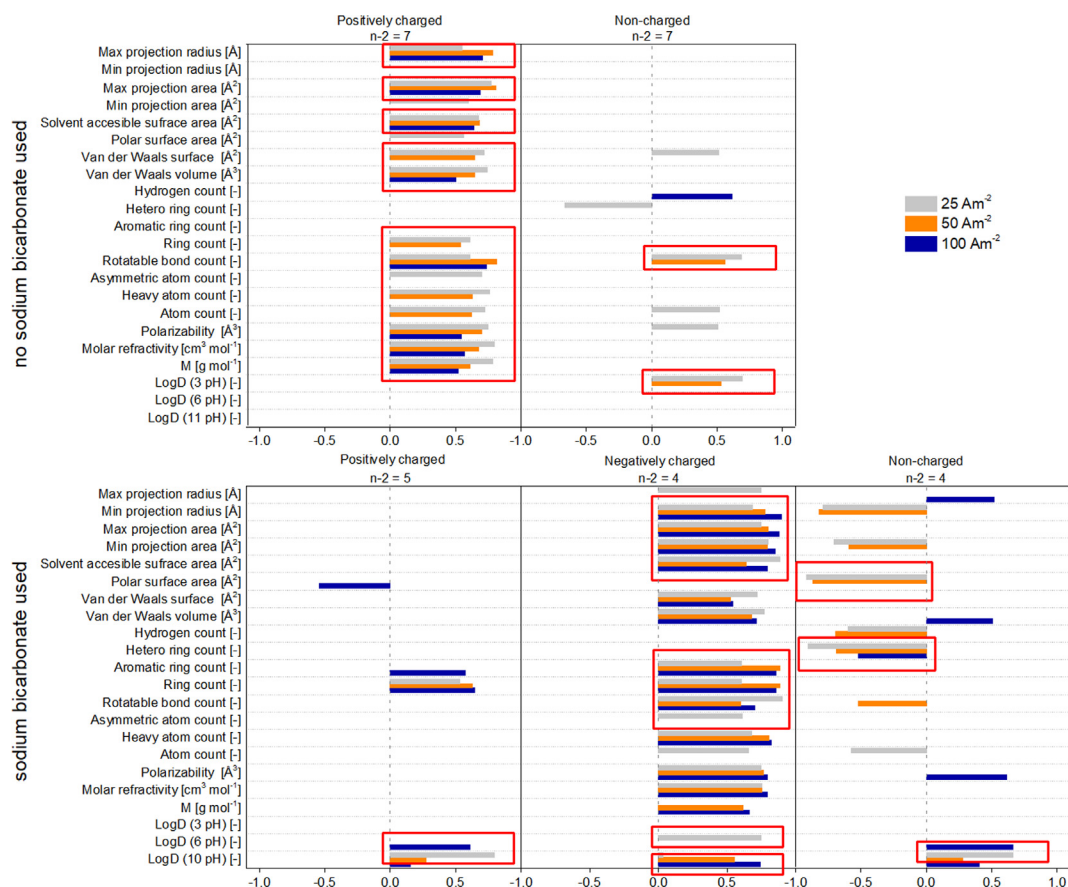

**Fig. 7.** Pearson's correlation coefficients ( $r$ ) between adsorption and physicochemical parameters of OMPs in buffered and non-buffered experiments. The coefficients were calculated at the point when the conductivities across the compartments were equal, and for  $n-2$  degrees of freedom. To calculate the correlation coefficients OMPs were divided into relevant groups. Only strong correlations ( $r \geq 0.5$  or  $r \leq -0.5$ ) were shown on the plot. The correlations where the  $p$ -value was lower than the level of significance ( $\alpha = 0.05$ ) are indicated by the red frames.

seawater. Unlike in neutral pH conditions, under low pH adsorption is equally high for all OMPs, independently on their charge. However, mechanisms of adsorption are still different between differently charged OMPs.

Buffered ED resulted in lowering the total adsorption of OMPs and depended on the contact time between OMPs and IEMs. The total adsorption varied among the groups of OMPs. Lowering the adsorption in these experiments resulted in observing their transport in seawater. Transport of OMPs was also dependent on their charge, where negatively charged OMPs were characterized by the highest transport associated with Donnan dialysis.

#### CRediT authorship contribution statement

**Malgorzata Roman:** Conceptualization, Writing - original draft, Writing - review & editing, Investigation, Formal analysis, Visualization. **Leonardo Gutierrez:** Validation, Supervision, Writing - review & editing. **Laurens H. Van Dijk:** Investigation. **Marjolein Vanoppen:** Writing - review & editing. **Jan W. Post:** Supervision, Writing - review & editing. **Bas A. Wols:** Validation, Writing - review & editing. **Emile R. Cornelissen:** Validation, Supervision, Writing - review & editing. **Arne R.D. Verliefde:** Validation, Supervision, Project administration, Writing - review & editing.

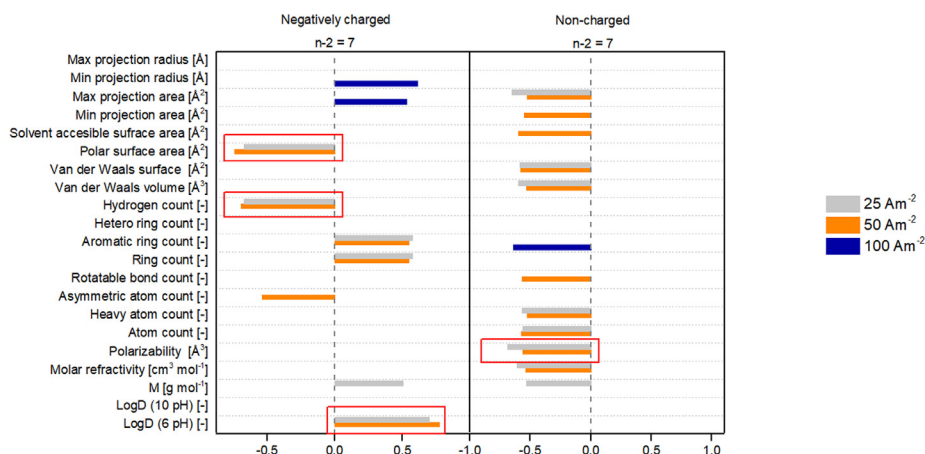

**Fig. 8.** Pearson's correlation coefficients ( $r$ ) between transport and physicochemical parameters of OMPs in buffered experiments, calculated at the time point when conductivity equilibrated across the compartments for  $n-2$  degrees of freedom. To calculate the correlation coefficients OMPs were divided into two groups: negatively and non-charged OMPs. Only strong correlations ( $r \geq 0.5$  or  $r \leq -0.5$ ) were shown on the plot. The correlations where the  $p$ -value was lower than the level of significance ( $\alpha = 0.05$ ) are indicated by the red frames.

## Declaration of Competing Interest

The authors declare that they have no known competing financial interests or personal relationships that could have appeared to influence the work reported in this paper.

## Acknowledgments

This work was performed in the cooperation framework of Wetsus, the European Centre of Excellence for Sustainable Water Technology ([www.wetsus.eu](http://www.wetsus.eu)). Wetsus is co-funded by the Dutch Ministry of Economic Affairs and Ministry of Infrastructure and Environment, the Province of Fryslân, and the Northern Netherlands Provinces. This project has also received funding from the European Union's Horizon 2020 research under grant agreement No 685579 ([www.revivedwater.eu](http://www.revivedwater.eu)). The authors would like to thank the participants of the research theme "Blue Energy" for their input, suggestions, and their financial support. Finally, the authors would like to express their gratitude to the Wetsus technical support team.

## Appendix A. Supplementary material

Supplementary data to this article can be found online at <https://doi.org/10.1016/j.seppur.2020.117487>.

## References

- [1] S. Jobling, M. Nolan, C.R. Tyler, G. Brighty, J.P. Sumpter, Widespread sexual disruption in wild fish, *Environ. Sci. Technol.* 32 (1998) 2498–2506.
- [2] A.R.D. Verliefde, Rejection of organic micropollutants by high pressure membranes (NF/RO), Delft University of Technology, TU Delft, 2008.
- [3] J.Y. Tang, S. McCarty, E. Glenn, P.A. Neale, M.S.J. Warne, B.I. Escher, Mixture effects of organic micropollutants present in water: towards the development of effect-based water quality trigger values for baseline toxicity, *Water Res.* 47 (2013) 3300–3314.
- [4] Q. Sui, X. Cao, S. Lu, W. Zhao, Z. Qiu, G. Yu, Occurrence, sources and fate of pharmaceuticals and personal care products in the groundwater: a review, *Emerg. Contaminants* 1 (2015) 14–24.
- [5] N. Bolong, A. Ismail, M.R. Salim, T. Matsuura, A review of the effects of emerging contaminants in wastewater and options for their removal, *Desalination* 239 (2009) 229–246.
- [6] S. Gabarrón, W. Gernjak, F. Valero, A. Barceló, M. Petrovic, I. Rodríguez-Roda, Evaluation of emerging contaminants in a drinking water treatment plant using electro dialysis reversal technology, *J. Hazard. Mater.* 309 (2016) 192–201.
- [7] O.A. Jones, N. Voulvoulis, J.N. Lester, Potential impact of pharmaceuticals on environmental health, *Bull. World Health Organ.* 81 (2003) 768–769.
- [8] I. Sirés, E. Brillas, Remediation of water pollution caused by pharmaceutical residues based on electrochemical separation and degradation technologies: a review, *Environ. Int.* 40 (2012) 212–229.
- [9] A. Verliefde, E. Cornelissen, G. Amy, B. Van der Bruggen, H. Van Dijk, Priority organic micropollutants in water sources in Flanders and the Netherlands and assessment of removal possibilities with nanofiltration, *Environ. Pollut.* 146 (2007) 281–289.
- [10] S.B. Grant, J.-D. Saphores, D.L. Feldman, A.J. Hamilton, T.D. Fletcher, P.L. Cook, M. Stewardson, B.F. Sanders, L.A. Levin, R.F. Ambrose, Taking the "waste" out of "wastewater" for human water security and ecosystem sustainability, *Science* 337 (2012) 681–686.
- [11] M. Vanoppen, G. Blandin, S. Derese, P. Le Clech, J. Post, A.R.D. Verliefde, Sustainable Energy from Salinity Gradients, Elsevier, 2016, pp. 281–313 10.1016/B978-0-08-100312-1.00009-2.
- [12] D. Bixio, C. Thoeye, J. De Koning, D. Joksimovic, D. Savic, T. Wintgens, T. Melin, Wastewater reuse in Europe, *Desalination* 187 (2006) 89–101.
- [13] C.Y. Tang, Z. Yang, H. Guo, J.J. Wen, L.D. Nghiem, E. Cornelissen, Potable water reuse through advanced membrane technology, ACS Publications, 2018.
- [14] M. Vanoppen, E. Criel, G. Walpot, D.A. Vermaas, A. Verliefde, Assisted reverse electro dialysis—principles, mechanisms, and potential, *NPJ Clean Water* 1 (2018) 9.
- [15] M. La Cerva, L. Gurreri, A. Cipollina, A. Tamburini, M. Ciofalo, G. Micale, Modelling and cost analysis of hybrid systems for seawater desalination: Electromembrane pre-treatments for Reverse Osmosis, *Desalination* 467 (2019) 175–195.
- [16] G. Doornbusch, M. Tedesco, J. Post, Z. Borneman, K. Nijmeijer, Experimental investigation of multistage electro dialysis for seawater desalination, *Desalination* 464 (2019) 105–114.
- [17] Y. Tanaka, Mass transport and energy consumption in ion-exchange membrane electro dialysis of seawater, *J. Membr. Sci.* 215 (2003) 265–279.
- [18] M. Turek, Cost effective electro dialytic seawater desalination, *Desalination* 153 (2003) 371–376.
- [19] P.T. Kelly, Z. He, Nutrients removal and recovery in bioelectrochemical systems: a review, *Bioresour. Technol.* 153 (2014) 351–360.
- [20] T.H. Sleutels, A. ter Heijne, P. Kuntke, C.J. Buisman, H.V. Hamelers, Membrane selectivity determines energetic losses for ion transport in bioelectrochemical systems, *ChemistrySelect* 2 (2017) 3462–3470.
- [21] L.J. Banasiak, B. Van der Bruggen, A.I. Schäfer, Sorption of pesticide endosulfan by electro dialysis membranes, *Chem. Eng. J.* 166 (2011) 233–239.
- [22] M. Roman, L. Van Dijk, L. Gutierrez, M. Vanoppen, J. Post, B. Wols, E. Cornelissen, A. Verliefde, Key physicochemical characteristics governing organic micropollutant adsorption and transport in ion-exchange membranes during reverse electro dialysis, *Desalination* 468 (2019) 114084.
- [23] J. Benesty, J. Chen, Y. Huang, I. Cohen, Pearson correlation coefficient, in: *Noise reduction in speech processing*, Springer, 2009, pp. 1–4.
- [24] Chemicalize was used for name to structure generation/prediction of physicochemical properties of OMPs, 17.12. 2019, developed by ChemAxon, , <https://chemicalize.com>, in, 2019.
- [25] M.A. Brusatori, Y. Tie, P.R. Van Tassel, Protein adsorption kinetics under an applied electric field: An optical waveguide lightmode spectroscopy study, *Langmuir* 19 (2003) 5089–5097.
- [26] G.Z. Kyzas, A. Koltsakidou, S.G. Nanaki, D.N. Bikiaris, D.A. Lambropoulou, Removal of beta-blockers from aqueous media by adsorption onto graphene oxide, *Sci. Total Environ.* 537 (2015) 411–420.
- [27] S. Carda-Broch, A. Berthod, pH dependence of the hydrophobicity of  $\beta$ -blocker amine compounds measured by counter-current chromatography, *J. Chromatogr. A* 995 (2003) 55–66.
- [28] P.W. Seo, B.N. Bhadra, I. Ahmed, N.A. Khan, S.H. Jung, Adsorptive removal of pharmaceuticals and personal care products from water with functionalized metal-organic frameworks: remarkable adsorbents with hydrogen-bonding abilities, *Sci. Rep.* 6 (2016) 34462.